

VERTICALE[®] SI FIXATION SYSTEM

INSTRUMENTATION GUIDE



MADE IN GERMANY

TABLE OF CONTENTS

Introduction	3
Intended Use	4
INSTRUMENTATION	6
Position and planning	6
Intraoperative C-arm imaging	7
Landmarks for stab incision	7
Placement of guide wire	8
Placement of an SI screw with washer	10
Placement of an SI screw with plate	15
PRODUCT INFORMATION	
Implants	PI 02
Instruments	PI 04
Alphabetical index	PI 06

NOTE: This guide describes the instrumentation of the VERTICALE® SI Fixation System. - This guide does not replace briefing by a physician experienced in the instrumentation used in spinal surgery.

We would be happy to assist you in finding a hospital that provides an opportunity to observe surgical procedures.

INTRODUCTION

VERTICALE[®] SI FIXATION SYSTEM

The VERTICALE[®] SI Fixation System is intended for surgical use in pelvic ring and iliosacral stabilization procedures.

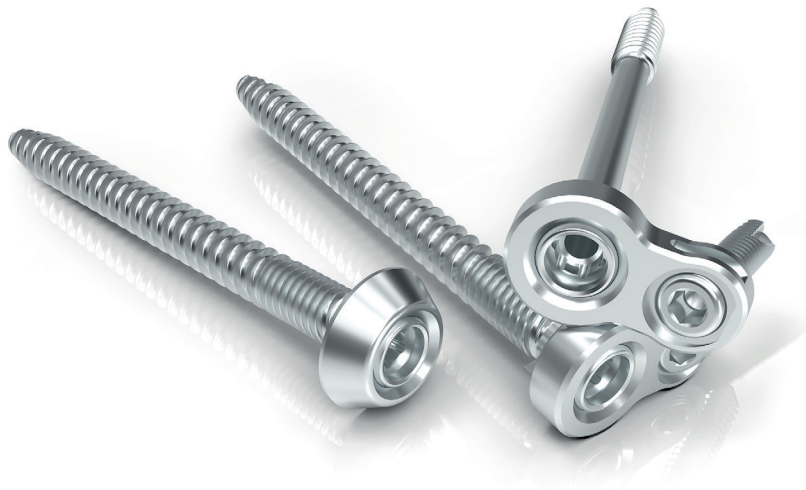

Benefits and features:

- 7.2 mm SI-screws with preassembled polyaxial plate or washer to fit anatomical and pathological requirements
- Fixed-angle locking plate screw to enhance primary fixation of the SI-Screw
- Quattro-lead thread at proximal screw shaft for enhanced fixation in iliac cortex
- Wide screw selection to fit anatomical and pathological requirements
- Full threaded screw in 70-140mm with preassembled plate or washer
- Lag-screw in 70-140mm with preassembled plate

Intended Use

The VERTICALE® SI Fixation System is intended for surgical use in pelvic ring and iliosacral stabilization procedures.

Indications

The VERTICALE® SI Fixation System is intended to be used in the following medical indications:

- Pelvic ring instabilities
- Iliosacral instabilities

Contraindications

- Anticipated or documented allergy or intolerance to the materials (e.g. titanium)
- Any case in which the chosen implants would be too large or too small to achieve a successful result
- Any patient for whom the use of the implant would conflict with anatomical structure
- Missing bone structures that render good anchoring of the implant impossible

Product-specific intended use:

VERTICALE SI Screw (ilio-sacral screw):

The SI screw is inserted from lateral through the iliac bone and the ala into the sacrum. Through the use of the partially threaded SI screw (lag screw) option, an additional compression of the fracture can be achieved.

The SI screw is made available in two options:

VERTICALE SI Screw with washer:

The washer distributes the load and avoids subsidence of the SI screw into the lateral iliac cortex.

VERTICALE SI Screw w. plate:

The plate enables fixation as a stable angle locking screw (VERTICALE SI Plate fixation screw) and avoids subsidence of the SI screw into the lateral iliac cortex.

NOTE: Please also note the Instructions for Use provided with each product. They may include additional advice that leads to exclusion of the implant procedure.

VERTICALE[®] SI FIXATION PREPARATION

Position and planning

The prone position is used for access to the sacrum and posterior SI regions. Prior to starting the procedure fluoroscopic AP, inlet and outlet x-rays should be obtained to ensure adequate visualization.

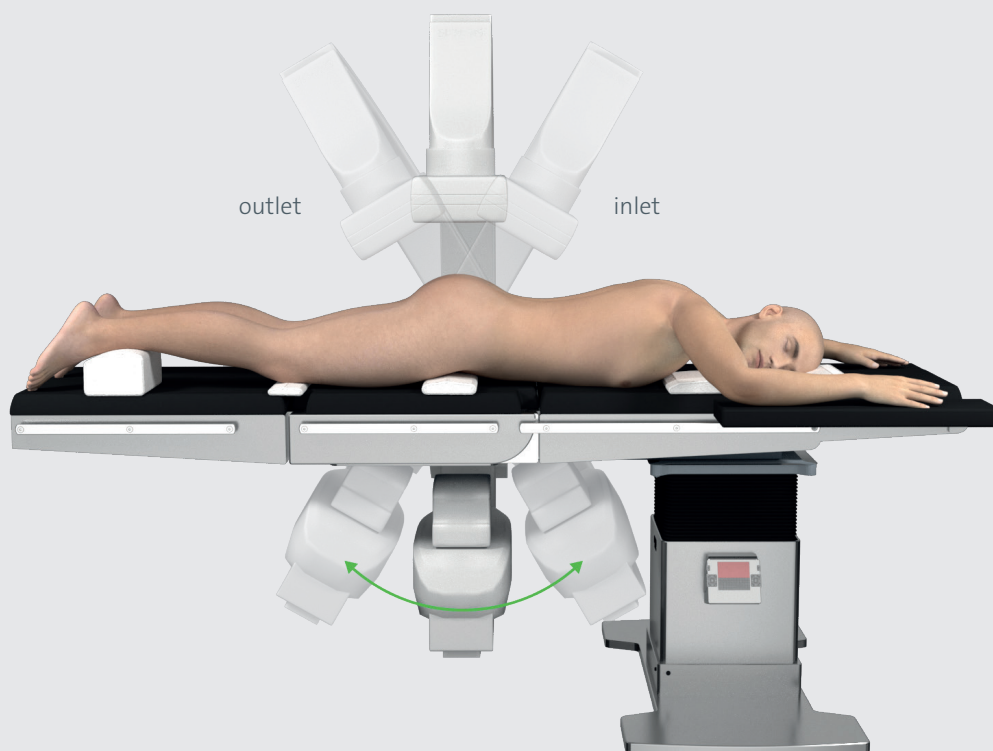

Fig. 1 Intra-operative imaging control

Intraoperative C-arm imaging

During setup for surgery, it is important to confirm the adequacy of fluoroscopic imaging. This is essential to avoid errors in SI-screw placement.

The following should be clearly identifiable:

- sacral foramina (outlet view)
- spinal canal (inlet view)
- S1 body (inlet view)

If these structures cannot be clearly seen, a safe trajectory for the SI screw cannot be determined.

It is recommended that before beginning an SI screw fixation procedure, appropriate preoperative planning for screw length, trajectory and location needs to be verified.

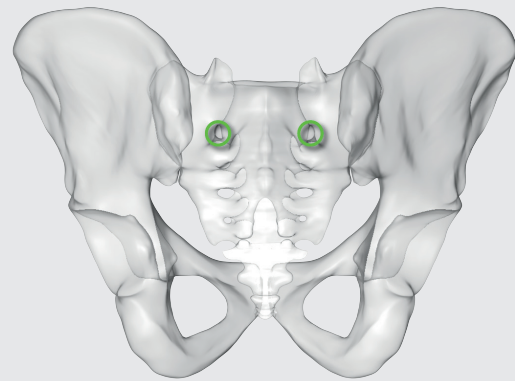

inlet

Fig. 2 Intra-operative imaging - inlet view

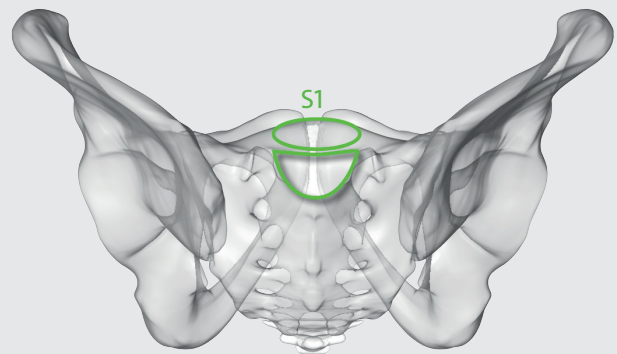

outlet

Fig. 3 Intra-operative imaging - outlet view

Landmarks for stab incision

On a lateral projection, identify the S1 body and iliac cortical densities (ICDs), here overlapping correctly.

The entry point should be posterior in S1 and inferior to the ICD, which parallels the sacral alar slope. The direction of the entry point is usually slightly caudal and posterior. The ICD thus marks the antero-superior boundary of the safe zone for an iliosacral screw. Having a safe entry point avoids injuring the L5 nerve root if it penetrates this cortex.

A 3-4 cm incision is made at the identified site

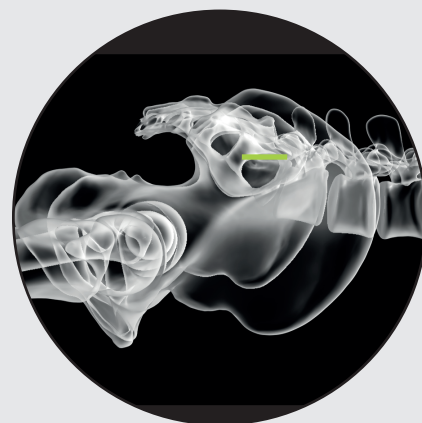

Fig. 4 Intra-operative imaging - lateral view

Placement of guide wire

RI-1355
ROCCIA Slotted Mallet, solid



VI-6050
VERTICALE Guide wire blunt



VI-6051
VERTICALE Guide wire trocar



VI-6052
VERTICALE Guide wire threaded



VI-6059
VERTICALE Guide wire protection sleeve

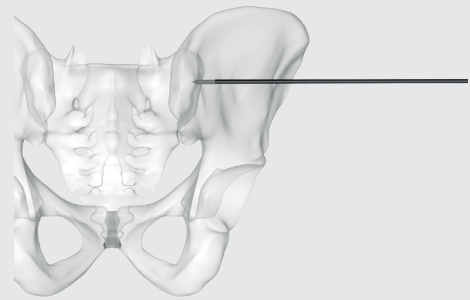

Fig. 5 Placement of guide wire - inlet view

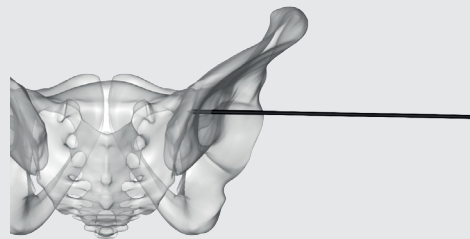

Fig. 6 Placement of guide wire - outlet view

When the desired entry position is identified, the 3.2mm guide wire is tapped 2-3 mm into the planned screw entry point. Confirmation of position is recommended using imaging intensifier in a lateral view.

If correct entry point is identified the guide wire is advanced 1 cm into the sacral ala according to chosen screw channel.

NOTE: If you use a hammer to advance the guide wire the guide wire protection sleeve must be used. Do not hammer on the guide wire tip to avoid damaging the wire.



Fig. 7 Do not use a hammer with the guidewire without protection sleeve

Placement of guide wire

Once the guidewire tip is lateral to the neural foramen in the outlet view, confirm that it is in the desired position using fluoroscopic imaging.

The desired trajectory is within, but close to the anterior alar cortex on the inlet view, and cranial to the ventral foramen of the 1st sacral nerve root.

If the trajectory of the guidewire would compromise either the sacral foramen or the spinal canal, the guidewire is removed and then reinserted from a similar entry point but in a corrected trajectory.

When the correct trajectory for the guidewire is confirmed, it is further advanced to the S1 vertebral body.

When the guide wire reaches the centre of S1, the position is again verified in lateral, inlet, and outlet view.

Advance the guide wire into the desired position for the SI-screw placement and length.

The wire must be far enough from cortices and neural foramina to accommodate the desired SI-screw.

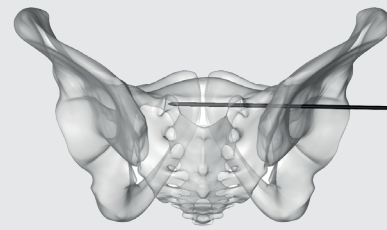

Outlet.

Fig. 8 Placement of guide wire - inlet view

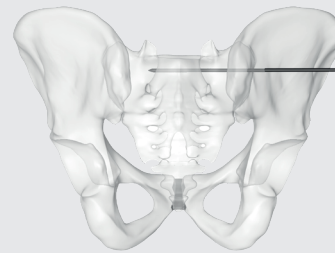

Inlet.

Fig. 9 Placement of guide wire - outlet view

VERTICALE[®] SI FIXATION

PLACEMENT OF SI SCREW WITH WASHER

Placement of an SI screw with washer

VI-6023
VERTICALE Dilator 17



VI-4024
VERTICALE MIS Dilator 4
(20 mm)



For blunt preparation of the tissue to access the iliac cortex, the 17mm Dilatation tube is placed over the wire. Slide the VERTICALE MIS Dilator (20 mm) over the 17 mm Dilatation Tube and push it down onto the iliac cortex. The 17 mm Dilatation Tube is removed. The Working Tube provides sufficient room for a protective screw bed preparation using an awl or drill and for the insertion of the SI-screw with washer.

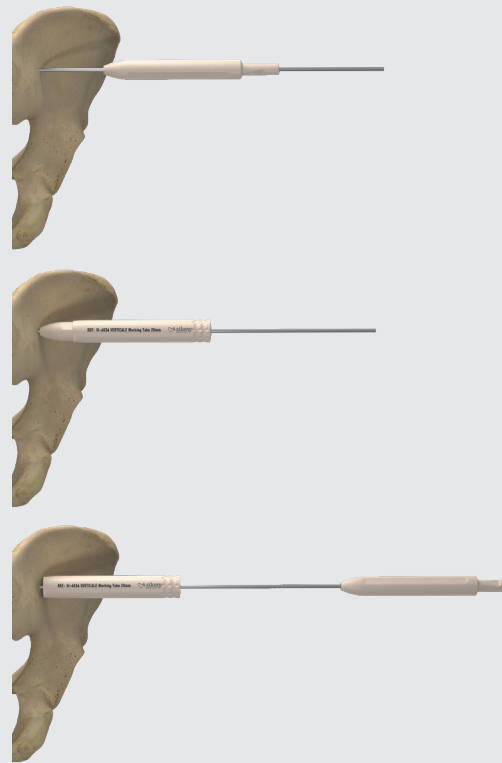

Fig. 10 Dilatation of soft tissues to perform lateral access to the os ilium

VI-6860
VERTICALE SI Screw Indicator



The screw length is measured using the VERTICALE SI Screw Indicator, which is guided over the guide wire and pushed onto the iliac cortex. The end of the guide wire indicates to the appropriate length of the SI-screw.

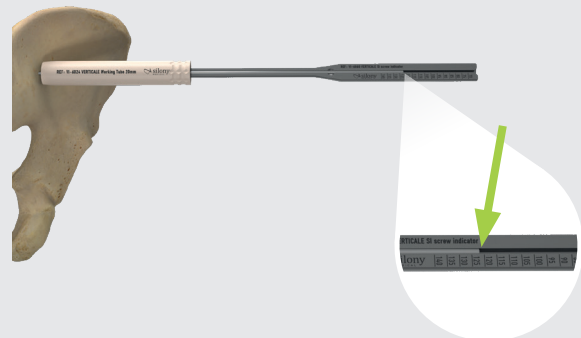

Fig. 11 Identification of screw length.

Placement of an SI screw with washer

VI-6070
VERTICALE Probe with ball



VI-6192
VERTICALE Drill Bit, cannulated



In normal bone the screw bed may be prepared for correct screw insertion using the VERTICALE Probe with ball tip to open the iliac cortex and the cannulated VERTICALE Drill Bit, to over-drill the guide wire to enhance SI-screw insertion.

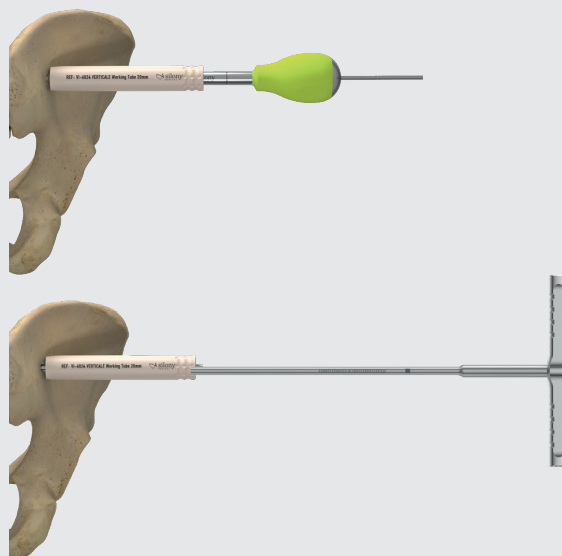

Fig. 12 Preparation of bone bed with probe and drill.

Placement of an SI screw with washer

GI-2111
Ratchet T-Handle, short



VI-6700.1
VERTICALE Screw Driver shaft



The selected VERTICALE SI Screw is placed over the guide wire.

Attach the Ratched T-Handle on the VERTICALE Screw Driver Shaft. Guide the Screw driver over the wire and push the torx into the screw head. Avoid tilting of the screw driver during insertion. Control screw insertion and guide wire position using imaging intensive control.

In normal bone the force for screw insertion will increase as the washer reaches the iliac cortex.

Tactile feed-back may not be observed in soft bones. It is therefore recommended to control the positioning of the washer onto the iliac cortex in an oblique inlet view.

When the SI Screw is in its desired position remove the screw driver.

VI-6000
VERTICALE Holding Clamp



When the SI-screw reaches the desired position the guide wire is removed.

Remove the guide wire and the working tube.

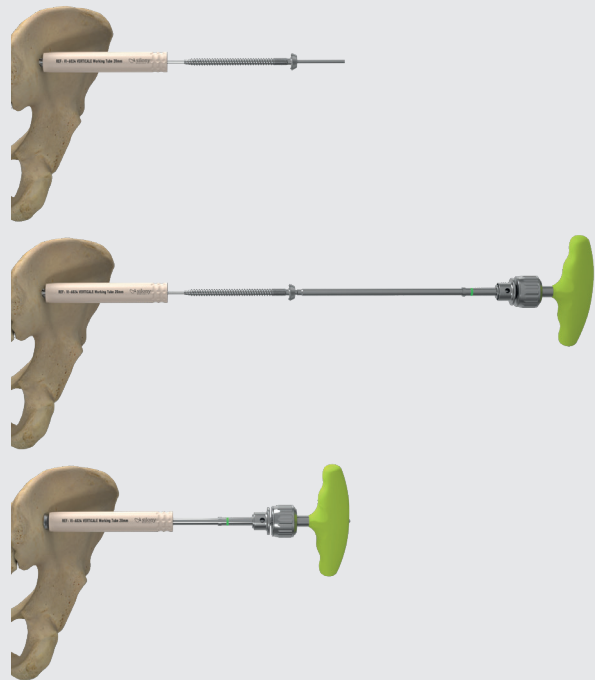

Fig. 13 Insertion of SI screw

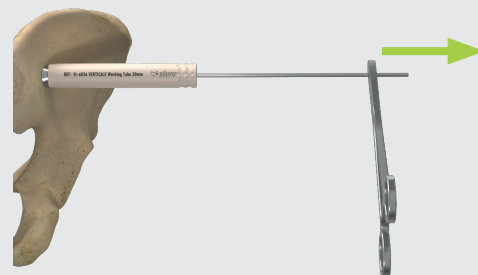

Fig. 14 Removal of guide wire.

Placement of an SI screw with washer

Upon completion of the SI-screw procedure, use fluoroscopy images to confirm the correct placement of the SI-screw. This should include AP, inlet, outlet, and lateral images of the posterior pelvis.

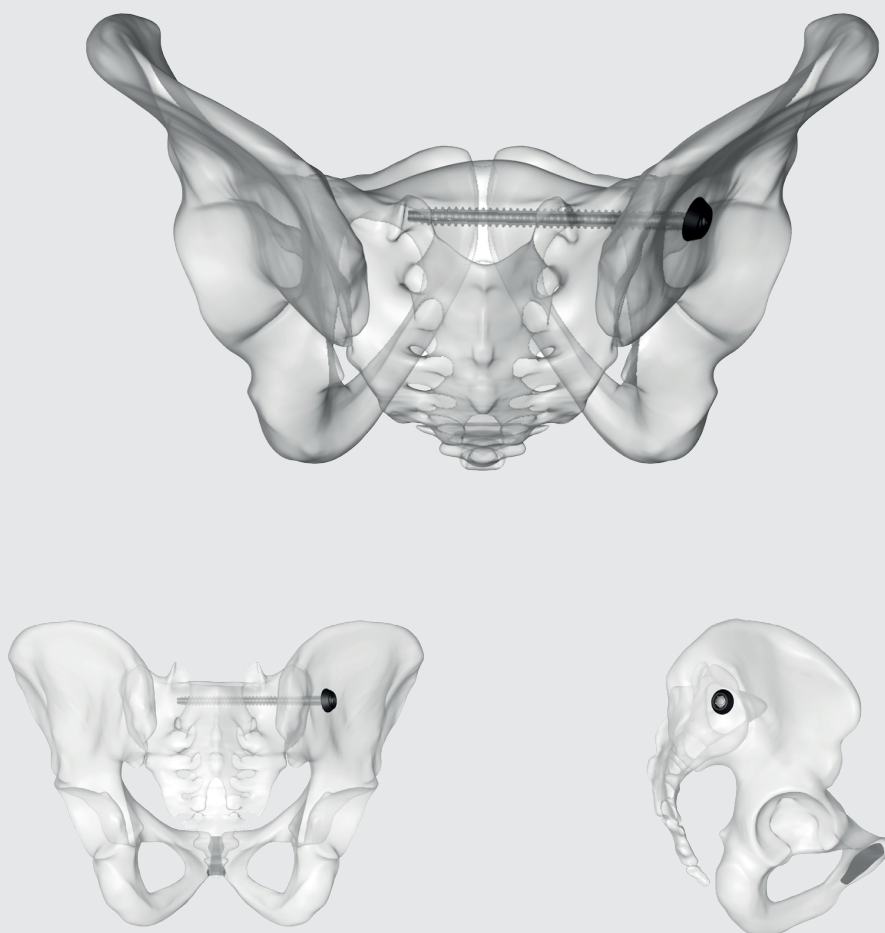

Fig. 15 Verification of final implantation using imaging intensifier control in inlet, outlet and lateral view.

VERTICALE[®] SI FIXATION

PLACEMENT OF SI SCREW WITH PLATE

Placement of an SI screw with plate

VI-6070
VERTICALE Probe with ball tip



VI-6192
VERTICALE Drill Bit, cannulated



VI-6860
VERTICALE SI Screw Indicator



After placement of the guide wire in the desired position the tissues are dissected down to bone, by spreading with an appropriate blunt clamp, or with scissors to ensure a 3-4 cm access to the iliac cortex for a protective screw bed preparation using the awl with stop or the drill.

The screw length is measured with the VERTICALE SI Screw Indicator, which is guided over the guide wire and pushed onto the iliac cortex. The end of the guide wire indicates the appropriate length of the SI-screw.

In normal bone the screw bed may be prepared for proper screw insertion using the VERTICALE Probe with ball tip to open the iliac cortex and the cannulated VERTICALE Drill Bit with T-handle to over-drill the guide wire to enhance SI-screw insertion.



Fig. 21 Identification of screw length.

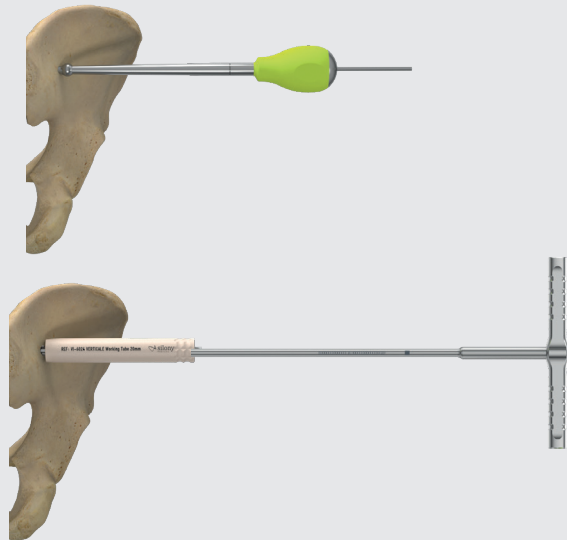

Fig. 16 Preparation of bone using probe and drill.

Placement of an SI screw with plate

VI-6700.1
VERTICALE SI Screw Driver shaft



GI-2111
Ratchet T-Handle, short



VI-6751.1 VERTICALE Plate
inserter inner sleeve



VI-6751.2 VERTICALE Plate
inserter outer sleeve



Slide the VERTICALE SI Plate inserter outer sleeve from lateral onto the plate (1). Insert the VERTICALE SI Plate inserter inner sleeve (2) and lock it to the outer sleeve by a quarter turn (3).

The VERTICALE SI Screw is placed over the guide wire.

Attach the Ratched T-Handle on the VERTICALE Screw Driver Shaft. Guide the Screw driver over the wire and push the torx into the screw head. Avoid tilting of the screw driver during insertion.

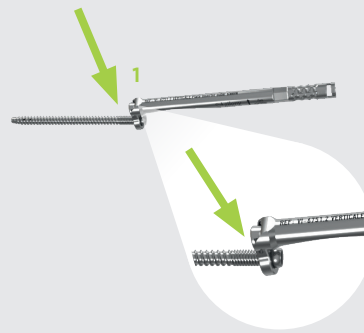

Fig. 17 Assembly of the Plateholder onto the SI plate - Step 1.

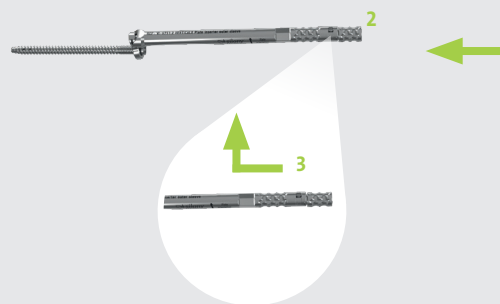

Fig. 18 Assembly of the Plateholder onto the SI plate - Step 2.

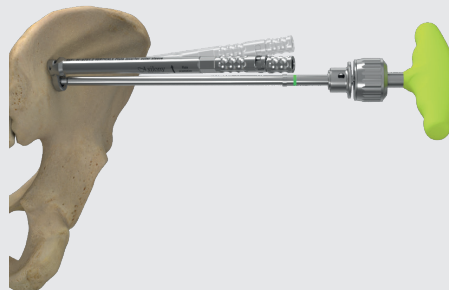

Fig. 19 Placement of SI Screw with assembled plate holder over the guide wire.

Placement of an SI screw with plate

Control the screw insertion and guide wire position using imaging intensive control.

In a normal bone the force for screw insertion will increase when the plate reaches the iliac cortex.

This tactile feed-back may not be observed in soft bones. Therefore it is recommended to control the positioning of the plate onto the iliac cortex in an oblique inlet view until the plate is firmly attached on the iliac cortex.

The SI screw should not be inserted completely until the plate is guided into the desired position. If needed unscrew the SI screw until the plate can be moved. A marking on the Plate Inserter outer sleeve indicates the orientation of the plate.

Position the plate into the desired position and enhances the SI screw until the plate is positioned firmly onto the iliac cortex.

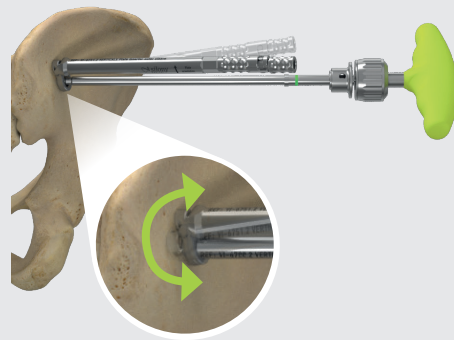

Fig. 20 Orientation of Plate

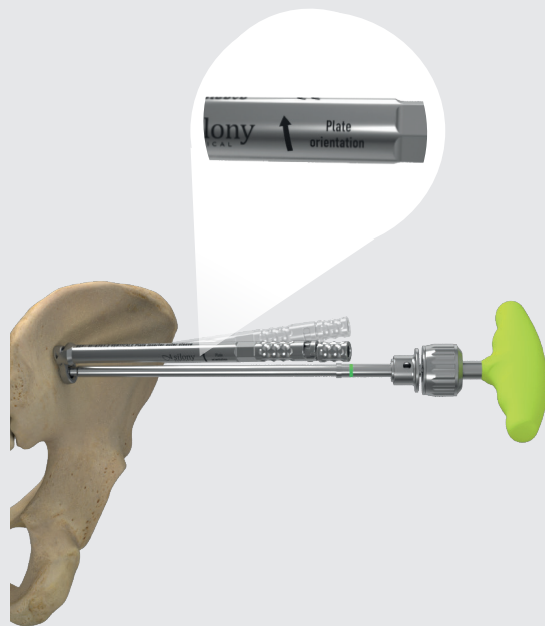

Fig. 21 Define final position of the plate.

Placement of an SI screw with plate

VI-6870.1
VERTICALE Plate Indicator



VI-6870.2
VERTICALE Plate Fixation Screw
Indicator



VI-6720
VERTICALE SI Wrench



VI-6710
VERTICALE Screwdriver Hex 3.5



GI-6141
VERTICALE Ratchet T-Handle,
4Nm



The correct position of the plate onto the cortex can be verified using the VERTICALE SI Plate Indicator. Also the length of the plate fixation screw can be identified. If the line of the plate indicator is visible it indicates that the plate is fully seated onto the iliac cortex.

Remove the screw driver and the guide wire.

Using the Plate Fixation Screw Indicator the length and position of the plate fixation screw can be verified. The length is indicated on the plate indicator.

Remove the plate indicator and the plate fixation screw indicator.

Attach the selected plate fixation screw to the VERTICALE Screw Driver Hex 3.5. Attach the T-handle with 4Nm torque and guide the Plate fixation screw through the SI Plate inserter. Use the VERTICALE SI Wrench as counter-torque. The screw must be inserted into the bone and the plate using the torque limiting T-Handle 4Nm until there is a tactile release which indicates that the required torque has been applied.



Fig. 22 Indicate required length of the plate fixation screw.



Fig. 23 Insertion of plate fixation screw.

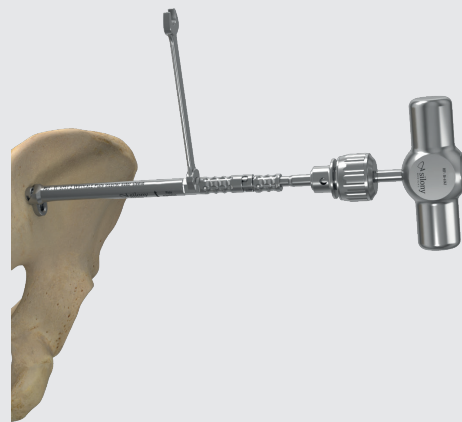

Fig. 24 final tightening of plate fixation screw

Placement of an SI screw with plate

Now unlock the Plate inserter inner sleeve from the outer sleeve by a quarter turn and remove it. The plate inserter outer sleeve must be slipped off the plate. The marking on the sleeve indicates the direction of movement.

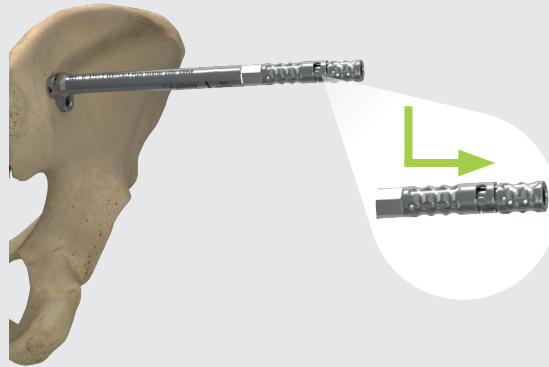

Fig. 25 Removal of SI plate holder - Step 1

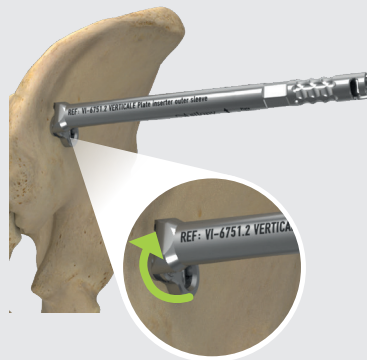

Fig. 26 Removal of SI plate holder - Step 2

Upon completion of the SI-screw with plate procedure, use appropriate imaging to confirm the correct placement of the SI screw. This should include AP, inlet, outlet, and true lateral images of the posterior pelvis.

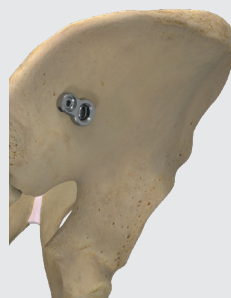

Fig. 27. Final Position of SI screw with plate

VERTICALE® SI FIXATION PRODUCT INFORMATION

VERTICALE SI Fixation Implants by article number	PI 02
VERTICALE SI Fixation Instruments by article number	PI 04
VERTICALE SI Fixation Index	PI 06

VERTICALE® SI Fixation Implants

System:
VERTICALE

Implant type:
SI Screw with Washer

Screw shaft diameter:
7.2 mm

Configuration:
Polyaxial, cannulated
and fenestrated shaft,
full threaded

Material:
Ti6Al4V ELI

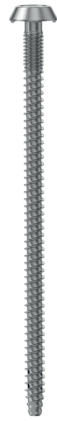
Article number	Description	Illustration
S-VOW-7070-CL1	VERTICALE SI screw with washer 7,2 x 70	
S-VOW-7075-CL1	VERTICALE SI screw with washer 7,2 x 75	
S-VOW-7080-CL1	VERTICALE SI screw with washer 7,2 x 80	
S-VOW-7085-CL1	VERTICALE SI screw with washer 7,2 x 85	
S-VOW-7090-CL1	VERTICALE SI screw with washer 7,2 x 90	
S-VOW-7095-CL1	VERTICALE SI screw with washer 7,2 x 95	
S-VOW-7100-CL1	VERTICALE SI screw with washer 7,2 x 100	
S-VOW-7105-CL1	VERTICALE SI screw with washer 7,2 x 105	
S-VOW-7110-CL1	VERTICALE SI screw with washer 7,2 x 110	
S-VOW-7115-CL1	VERTICALE SI screw with washer 7,2 x 115	
S-VOW-7120-CL1	VERTICALE SI screw with washer 7,2 x 120	
S-VOW-7125-CL1	VERTICALE SI screw with washer 7,2 x 125	
S-VOW-7130-CL1	VERTICALE SI screw with washer 7,2 x 130	
S-VOW-7135-CL1	VERTICALE SI screw with washer 7,2 x 135	
S-VOW-7140-CL1	VERTICALE SI screw with washer 7,2 x 140	

System:
VERTICALE

Implant type:
SI Screw with Plate

Screw shaft diameter:
7.2 mm

Configuration:
Polyaxial, cannulated
and fenestrated shaft,
full threaded

Material:
Ti6Al4V ELI

Article number	Description	Illustration
S-VOP-7070-CL1	VERTICALE SI screw w. plate 7,2 x 70	
S-VOP-7075-CL1	VERTICALE SI screw w. plate 7,2 x 75	
S-VOP-7080-CL1	VERTICALE SI screw w. plate 7,2 x 80	
S-VOP-7085-CL1	VERTICALE SI screw w. plate 7,2 x 85	
S-VOP-7090-CL1	VERTICALE SI screw w. plate 7,2 x 90	
S-VOP-7095-CL1	VERTICALE SI screw w. plate 7,2 x 95	
S-VOP-7100-CL1	VERTICALE SI screw w. plate 7,2 x 100	
S-VOP-7105-CL1	VERTICALE SI screw w. plate 7,2 x 105	
S-VOP-7110-CL1	VERTICALE SI screw w. plate 7,2 x 110	
S-VOP-7115-CL1	VERTICALE SI screw w. plate 7,2 x 115	
S-VOP-7120-CL1	VERTICALE SI screw w. plate 7,2 x 120	
S-VOP-7125-CL1	VERTICALE SI screw w. plate 7,2 x 125	
S-VOP-7130-CL1	VERTICALE SI screw w. plate 7,2 x 130	
S-VOP-7135-CL1	VERTICALE SI screw w. plate 7,2 x 135	
S-VOP-7140-CL1	VERTICALE SI screw w. plate 7,2 x 140	

 D30174

VERTICALE®SI Fixation Implants

Article number	Description	Illustration
S-VOP-7070-CS1	VERTICALE SI lag screw w. plate 7,2 x 70	
S-VOP-7075-CS1	VERTICALE SI lag screw w. plate 7,2 x 75	
S-VOP-7080-CS1	VERTICALE SI lag screw w. plate 7,2 x 80	
S-VOP-7085-CS1	VERTICALE SI lag screw w. plate 7,2 x 85	
S-VOP-7090-CS1	VERTICALE SI lag screw w. plate 7,2 x 90	
S-VOP-7095-CS1	VERTICALE SI lag screw w. plate 7,2 x 95	
S-VOP-7100-CS1	VERTICALE SI lag screw w. plate 7,2 x 100	
S-VOP-7105-CS1	VERTICALE SI lag screw w. plate 7,2 x 105	
S-VOP-7110-CS1	VERTICALE SI lag screw w. plate 7,2 x 110	
S-VOP-7115-CS1	VERTICALE SI lag screw w. plate 7,2 x 115	
S-VOP-7120-CS1	VERTICALE SI lag screw w. plate 7,2 x 120	
S-VOP-7125-CS1	VERTICALE SI lag screw w. plate 7,2 x 125	
S-VOP-7130-CS1	VERTICALE SI lag screw w. plate 7,2 x 130	
S-VOP-7135-CS1	VERTICALE SI lag screw w. plate 7,2 x 135	
S-VOP-7140-CS1	VERTICALE SI lag screw w. plate 7,2 x 140	

System:
VERTICALE

Implant type:
SI Lag Screw with Plate

Screw shaft diameter:
7.2 mm

Configuration:
Polyaxial, cannulated and fenestrated shaft, partially threaded

Length of thread:
20 mm for screws in length
70-90 mm
32 mm for screws in length
95-140 mm

Material:
Ti6Al4V ELI

Article number	Description	Illustration
S-VOP-0016-X1	VERTICALE SI Plate fixation screw 16 mm	
S-VOP-0018-X1	VERTICALE SI Plate fixation screw 18 mm	
S-VOP-0020-X1	VERTICALE SI Plate fixation screw 20 mm	
S-VOP-0022-X1	VERTICALE SI Plate fixation screw 22 mm	
S-VOP-0024-X1	VERTICALE SI Plate fixation screw 24 mm	
S-VOP-0026-X1	VERTICALE SI Plate fixation screw 26 mm	
S-VOP-0028-X1	VERTICALE SI Plate fixation screw 28 mm	
S-VOP-0030-X1	VERTICALE SI Plate fixation screw 30 mm	

System:
VERTICALE

Implant type:
Plate Fixation Screw

Configuration:
Solid, locking,
self-tapping









Material:
Ti6Al4V ELI

 D30174

VERTICALE® SI FIXATION Instruments

Article number	Description	Illustration	Page
GI-2111	Ratchet T-Handle, short		13, 17
GI-6141	Ratchet T-Handle, 4Nm		19
RI-1355	ROCCIA Slotted Mallet, solid		8
VI-4024	VERTICALE MIS Dilator 4 (20 mm)		11
VI-6000	VERTICALE Holding Clamp		14, 19
VI-6023	VERTICALE Dilator 17 mm		11
VI-6050	VERTICALE Guide wire blunt, 3.2 x 400 mm		8
VI-6051	VERTICALE Guide wire trocar, 3.2 x 400 mm		8
VI-6052	VERTICALE Guide wire threaded 3.2 x 400 mm		8
VI-6059	VERTICALE Guide wire protection sleeve		8
VI-6070	VERTICALE Probe with ball tip		12, 16
VI-6192	VERTICALE Drill Bit, cannulated		12, 16
VI-6700.1	VERTICALE SI Screw Driver shaft		13, 17

VERTICALE® MIS Instruments

Article number	Description	Illustration	Page
VI-6710	VERTICALE Screwdriver Hex 3.5		19
VI-6720	VERTICALE SI Wrench		19
VI-6730	VERTICALE SI Screw Loading Tool		13
VI-6751.1	VERTICALE Plate inserter inner sleeve		17
VI-6751.2	VERTICALE Plate inserter outer sleeve		17
VI-6860	VERTICALE SI screw indicator		11, 16
VI-6870.1	VERTICALE Plate Indicator		19
VI-6870.2	VERTICALE Plate Fixation Screw Indicator		19

VERTICALE® Alphabetical Index

A-Z	Description	Article number	Page
D	VERTICALE MIS Dilator 4 (20 mm)	VI-4024	11, PI 04
	VERTICALE Dilator 17 mm	VI-6023	11, PI 04
	VERTICALE Drill Bit, cannulated	VI-6192	12, 16, PI 04
G	VERTICALE Guide wire blunt, 3.2 x 400 mm	VI-6050	8, PI 04
	VERTICALE Guide wire trocar, 3.2 x 400 mm	VI-6051	8, PI 04
	VERTICALE Guide wire threaded 3.2 x 400 mm	VI-6052	8, PI 04
	VERTICALE Guide wire protection sleeve	VI-6059	8, PI 04
H	VERTICALE Holding Clamp	VI-6000	13, PI 04
P	VERTICALE Plate Fixation Screw Indicator	VI-6870.2	19, PI 05
	VERTICALE Plate Indicator	VI-6870.1	19, PI 05
	VERTICALE Plate inserter inner sleeve	VI-6751.1	17, PI 05
	VERTICALE Plate inserter outer sleeve	VI-6751.2	17, PI 05
	VERTICALE Probe with ball tip	VI-6070	12, 16, PI 04
T	Ratchet T-Handle, short	GI-2111	13, 17, PI 04
	Ratchet T-Handle, 4Nm	GI-6141	19, PI 04
S	VERTICALE Screwdriver Hex 3.5	VI-6710	19, PI 05
	VERTICALE SI Screw Driver shaft	VI-6700.1	13, 17, PI 04
	VERTICALE SI Screw indicator	VI-6860	11, 16, PI 05
	VERTICALE SI Screw Loading Tool	VI-6730	13, PI 05
	ROCCIA Slotted Mallet, solid	RI-1355	8, PI 04
W	VERTICALE SI Wrench	VI-6720	19, PI 05



 **Silony Medical GmbH**
Leinfelder Straße 60
70771 Leinfelden-Echterdingen
Germany
Tel +49 711 78 25 25 0
Fax +49 711 78 25 25 11
www.silony-medical.com

 elabeling.silony-medical.com/contact

D30172.b.EN 01.06.2022

CE 0483

