

CATÁLOGO DE PRODUCTOS | PRODUCT CATALOG | CATÁLOGO DE PRODUCTOS

COLUNA | SPINE | COLUMNA



É proibida a
reprodução dos textos
e imagens contidos
nesta publicação sem a
autorização por escrito
dos responsáveis.
Imagens meramente
ilustrativas.

The reproduction
of texts and images
from this publication
is forbidden without
written authorization
from its responsible.
Illustrative images.

Es prohibida la
reproducción de los
textos e imágenes
contenidos en esa
publicación sin la
autorización escrita
de los responsables.
Imágenes ilustrativas.

SUMÁRIO
CONTENTS
ÍNDICE

NEOSPINE - PARAFUSO PEDICULAR NEOSPINE - PEDICULAR SCREW NEOSPINE - TORNILLO PEDICULAR	03
NEOSPINE - PEDICULAR PEDIÁTRICO NEOSPINE - PEDIATRIC PEDICULAR NEOSPINE - PEDICULAR PEDIÁTRICO	25
NEOSPINE - PARAFUSO PEDICULAR CANULADO NEOSPINE - CANNULATED PEDICULAR SCREW NEOSPINE - TORNILLO PEDICULAR CANULADO	43
NEOSPINE - ESCOLIOSE NEOSPINE - SCOLIOSIS NEOSPINE - ESCOLIOSIS	63
NEOSPACE - CAGE LOMBAR PARALELO (PLIF) NEOSPACE - PARALLEL LUMBAR CAGE (PLIF) NEOSPACE - CAGE LUMBAR PARALELO (PLIF)	69
NEOSPACE - CAGE LOMBAR TRANSFORAMINAL (TLIF) NEOSPACE - TRANSFORAMINAL LUMBAR CAGE (TLIF) NEOSPACE - CAGE LUMBAR TRANSFORAMINAL (TLIF)	77
NEOSPACE - CAGE LOMBAR ANTERIOR (ALIF) NEOSPACE - ANTERIOR LUMBAR CAGE (ALIF) NEOSPACE - CAGE LUMBAR ANTERIOR (ALIF)	85
NEOSPACE - CAGE CERVICAL ANTERIOR NEOSPACE - ANTERIOR CERVICAL CAGE NEOSPACE - CAGE CERVICAL ANTERIOR	91
NEOSPACE - CAGE CERVICAL AUTOBLOQUEANTE NEOSPACE - SELF-LOCKING CERVICAL CAGE NEOSPACE - CAGE CERVICAL AUTOBLOQUEO	97
NEOSPACE - CAGE CILÍNDRICO CERVICAL NEOSPACE - CERVICAL CYLINDRICAL CAGE NEOSPACE - CAGE CILÍNDRICO CERVICAL	105
NEOSPACE - CAGE CILÍNDRICO LOMBAR NEOSPACE - LUMBAR CYLINDRICAL CAGE NEOSPACE - CAGE CILÍNDRICO LOMBAR	111
NEOPLATE - PLACA TORACOLOMBAR NEOPLATE - THORACOLUMBAR PLATE NEOPLATE - PLACA TORACOLUMBAR	117
NEOPLATE - PLACA CERVICAL ANTERIOR G2 NEOPLATE - G2 ANTERIOR CERVICAL PLATE NEOPLATE - PLACA CERVICAL ANTERIOR G2	129
NEOPLATE - PLACA CONJUGADA CERVICAL NEOPLATE - CERVICAL CAGE PLATE NEOPLATE - PLACA CONJUGADA CERVICAL	139
NEOCCIPITO - SISTEMA DE FIXAÇÃO OCCIPITOCERVICAL NEOCCIPITO - OCCIPITOCERVICAL FIXATION SYSTEM NEOCCIPITO - SISTEMA DE FIJACIÓN OCCIPITOCERVICAL	147
FIXADOR INTERNO INTERNAL FIXATOR FIJADOR INTERNO	161
PARAFUSO CANULADO CERVICAL (ODONTÓIDE) CERVICAL CANNULATED SCREW (ODONTOID) TORNILLO CANULADO CERVICAL (ODONTOIDES)	173

UMA NOVA SOLUÇÃO

A NEW SOLUTION

UNA NUEVA SOLUCIÓN

A NEOORTHO é uma empresa brasileira fabricante de implantes ortopédicos. Com um portfólio composto por mais de 16.000 itens em crescente expansão, tem excelente aceitação no mercado. Atualmente comercializa cinco linhas (Bucomaxilo, Coluna, Trauma, Prótese e Biomateriais), com incremento constante de novos itens.

A empresa investe constantemente na capacitação de mão de obra especializada e em equipamentos e máquinas de última geração. Unidos à uma ampla rede de distribuição, a NEOORTHO atende com excelência e agilidade o mercado nacional e internacional.

Mais que implantes, a NEOORTHO apresenta ao mercado soluções que facilitam as práticas médicas e dão maior segurança e bem estar aos pacientes.

NEOORTHO is a manufacturer of orthopedic implants based in Brazil. Our portfolio of over 16,000 items is constantly expanding and growing in market share. We currently feature five specific product lines (CMF, Spine, Trauma, Prosthesis and Biomaterials), with a steady flow of new items to come.

We invest constantly in specialized training, new equipment, and cutting-edge machines. With an extensive distribution network, NEOORTHO serves the national and international market with excellence and agility.

More than implants, NEOORTHO presents solutions that facilitate medical practices and provide greater safety and well-being for patients.

NEOORTHO es una empresa brasileña fabricante de implantes ortopédicos. Con un portafolio de más de 16.000 artículos en expansión ascendente, tiene una excelente aceptación en el mercado. Actualmente comercializa cinco líneas (CMF, Columna, Trauma, Prótesis y Biomateriales), con aumento constante de nuevos artículos.

La empresa invierte constantemente en la capacitación laboral especializada, de equipos y máquinas de última generación. Unidos a una amplia red de distribución, NEOORTHO cumple con la excelencia y la agilidad del mercado nacional e internacional.

Más que implantes, la NEOORTHO presenta soluciones para el mercado que facilitan las prácticas médicas y proporcionan mayor seguridad y bienestar de pacientes.



QUALIDADE ASSEGURADA

GUARANTEED QUALITY

CALIDAD GARANTIZADA

A Neoortho construiu um Sistema de Gestão da Qualidade de forma a atender aos padrões nacionais e internacionais de excelência na produção de produtos médicos com alto grau de segurança e qualidade.

Neoortho's Quality Management System meets national and international standards of excellence for the production of medical products with a high degree of safety and quality.

Neoortho construyó un Sistema de Gestión de la Calidad a fin de cumplir con las normas nacionales e internacionales de excelencia en la producción de productos médicos con un alto grado de seguridad y calidad.

**ISO
13485**

**ANVISA
CBPF**

**FDA
Clearance**

Consulte quais as certificações de cada sistema.

Refer to the certifications for each system.

Consulte as certificaciones de cada sistema.

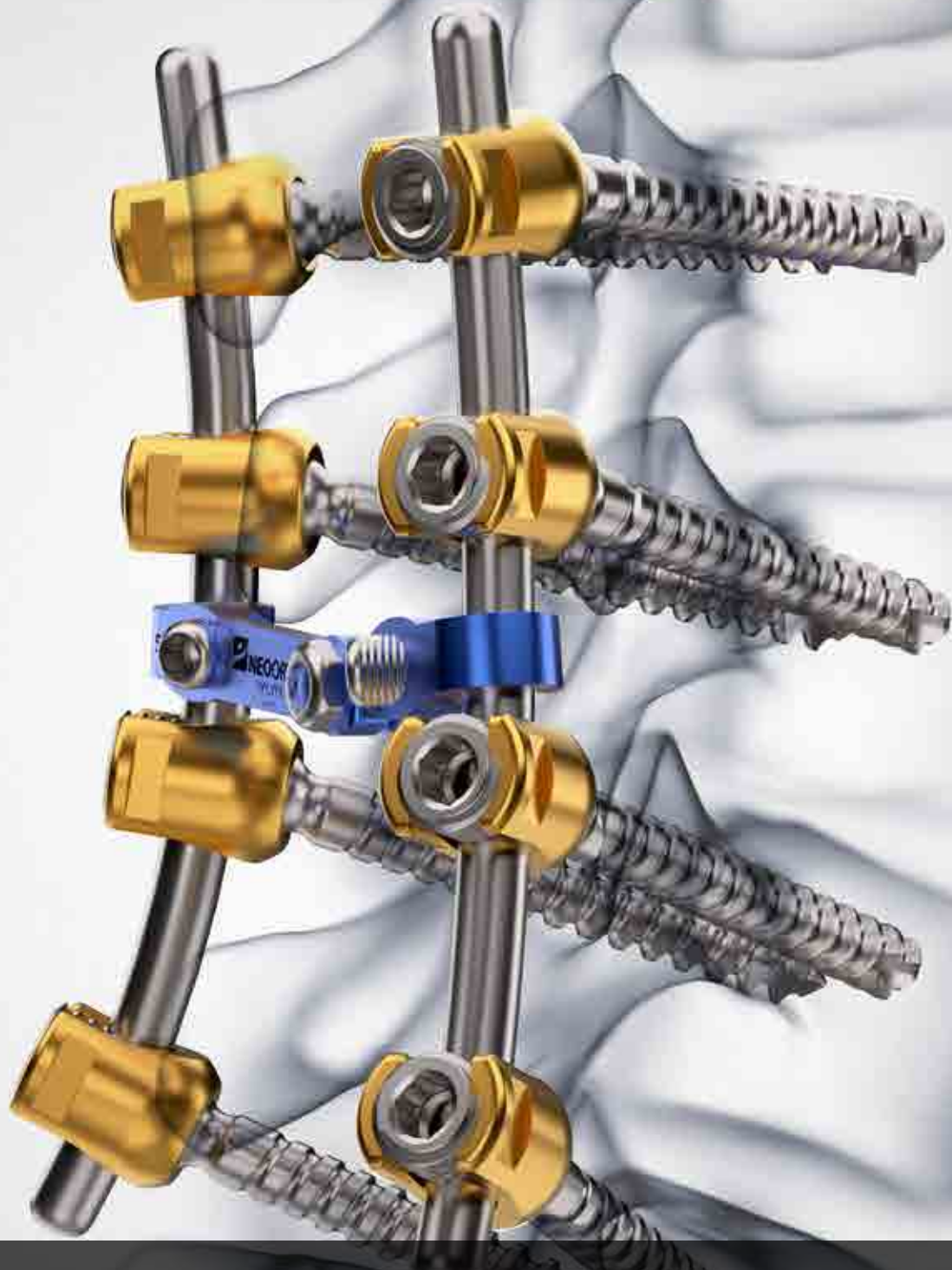

NEOSPINE - PARAFUSO PEDICULAR

NEOSPINE - PEDICULAR SCREW

NEOSPINE - TORNILLO PEDICULAR

CONTAINER
CONTAINER
ESTUCHES

951.124

Container Termoformado Implantes
Implants Thermoformed Container
Estuche Termoformado Implantes



951.053

Conjunto do Container com Implantes e Instrumental
Container with Implants and Instruments Set
Conjunto del Estuche con Implantes e Instrumentales

PARAFUSO PEDICULAR MONOAXIAL
 MONO-AXIAL PEDICULAR SCREW
 TORNILLO PEDICULAR MONO-AXIAL



	Ø4.5 mm	Ø5.5 mm	Ø6.5 mm	Ø7.5 mm	Ø8.5 mm
25 mm	940.022	•	•	•	•
30 mm	940.023	940.030	940.036	940.042	940.048
35 mm	940.024	940.031	940.037	940.043	940.049
40 mm	940.670	940.032	940.038	940.044	940.050
45 mm	940.671	940.033	940.039	940.045	940.051
50 mm	940.672	940.034	940.040	940.046	940.052
55 mm	940.673	940.035	940.041	940.047	940.053
60 mm	940.674	940.540	940.543	940.552	940.561
65 mm	940.675	940.541	940.544	940.553	940.562
70 mm	•	940.542	940.545	940.554	940.563
75 mm	•	•	940.546	940.555	940.564
80 mm	•	•	940.547	940.556	940.565
85 mm	•	•	940.548	940.557	940.566
90 mm	•	•	940.549	940.558	940.567
95 mm	•	•	940.550	940.559	940.568
100 mm	•	•	940.551	940.560	940.569

PARAFUSO PEDICULAR POLIAXIAL
 POLYAXIAL PEDICULAR SCREW
 TORNILLO PEDICULAR POLI-AXIAL



	Ø4.5 mm	Ø5.5 mm	Ø6.5 mm	Ø7.5 mm	Ø8.5 mm
25 mm	940.401	•	•	•	•
30 mm	940.402	940.407	940.413	940.419	940.322
35 mm	940.403	940.408	940.414	940.420	940.323
40 mm	940.570	940.409	940.415	940.421	940.324
45 mm	940.571	940.410	940.416	940.422	940.325
50 mm	940.572	940.411	940.417	940.423	940.326
55 mm	940.573	940.412	940.418	940.424	940.327
60 mm	940.574	940.576	940.579	940.588	940.661
65 mm	940.575	940.577	940.580	940.589	940.662
70 mm	•	940.578	940.581	940.590	940.663
75 mm	•	•	940.582	940.591	940.664
80 mm	•	•	940.583	940.592	940.665
85 mm	•	•	940.584	940.593	940.666
90 mm	•	•	940.585	940.594	940.667
95 mm	•	•	940.586	940.595	940.668
100 mm	•	•	940.587	940.596	940.669

PARAFUSO PEDICULAR POLIAXIAL ESPONDILOLISTESE
 SPONDYLOLISTHESIS POLYAXIAL PEDICULAR SCREW
 TORNILLO PEDICULAR POLIAXIAL ESPONDILOLISTESE



	Ø4.5 mm	Ø5.5 mm	Ø6.5 mm	Ø7.5 mm
25 mm	943.401	•	•	•
30 mm	943.402	943.412	943.422	943.442
35 mm	943.403	943.413	943.423	943.443
40 mm	943.404	943.414	943.424	943.444
45 mm	943.405	943.415	943.425	943.445
50 mm	943.406	943.416	943.426	943.446
55 mm	943.407	943.417	943.427	943.447
60 mm	943.408	943.418	943.428	943.448
65 mm	943.409	943.419	943.429	943.449
70 mm	•	943.420	943.430	943.450
75 mm	•	•	943.431	943.451
80 mm	•	•	943.432	943.452
85 mm	•	•	943.433	943.453
90 mm	•	•	943.434	943.454
95 mm	•	•	•	943.455
100 mm	•	•	•	94.456

PARAFUSO PEDICULAR MONOAXIAL ESPONDILOLISTESE
 SPONDYLOLISTHESIS MONO-AXIAL PEDICULAR SCREW
 TORNILLO PEDICULAR MONO-AXIAL ESPONDILOLISTESIS



	Ø5.5 mm	Ø6.5 mm	Ø7.5 mm	Ø8.5 mm
30 mm	940.086	940.092	940.170	940.176
35 mm	940.087	940.093	940.171	940.177
40 mm	940.088	940.094	940.172	940.178
45 mm	940.089	940.095	940.173	940.179
50 mm	940.090	940.096	940.174	940.180
55 mm	940.091	940.097	940.175	940.181

BARRA TRANSVERSAL FLEXÍVEL
 FLEXIBLE TRANSVERSAL ROD
 BARRA TRANSVERSAL FLEXIBLE



Código Code Código	Comprimento Length Largo
940.333	30 - 35 mm
940.332	36 - 41 mm
940.328	42 - 52 mm
940.329	52 - 62 mm
940.330	62 - 72 mm
940.331	72 - 82 mm

BARRA TRANSVERSAL FIXA
 FIXED TRANSVERSAL ROD
 BARRA TRANSVERSAL FIJA



Código Code Código	Comprimento Length Largo
940.185	25 mm
940.186	30 mm
940.187	35 mm
940.188	40 mm
940.189	45 mm

CONECTOR AXIAL
 AXIAL CONNECTOR
 CONECTOR AXIAL



Código
 Code
 Código

940.140

GANCHO
 HOOK
 GANCHO

940.135

Laminar Esquerdo
 Left Laminar
 Laminar Izquierdo



940.134

Laminar Direito
 Right Laminar
 Laminar Derecho



940.133

Pedicular



940.132

Laminar



940.130

Torácico Curto
 Short Thoracic
 Torácico Corto



940.131

Torácico Longo
 Long Thoracic
 Torácico Largo



940.150

Conector Transversal
 Transversal Connector
 Conector Transversal



GRAMPO COM DUPLA FURAÇÃO
 DOUBLE HOLE STAPLE
 GRAPA DOBLE AGUJERO



Código Code Código	Tamanho Size Tamaño	Descrição Description Descripción
945.030	Pequeno Small	Cranial
945.031	Pequeno Pequeño	Caudal
945.032	Médio Medium	Cranial
945.033	Medio	Caudal
945.034	Grande Large	Cranial
945.035	Grande	Caudal

GRAMPO
 STAPLE
 GRAPA

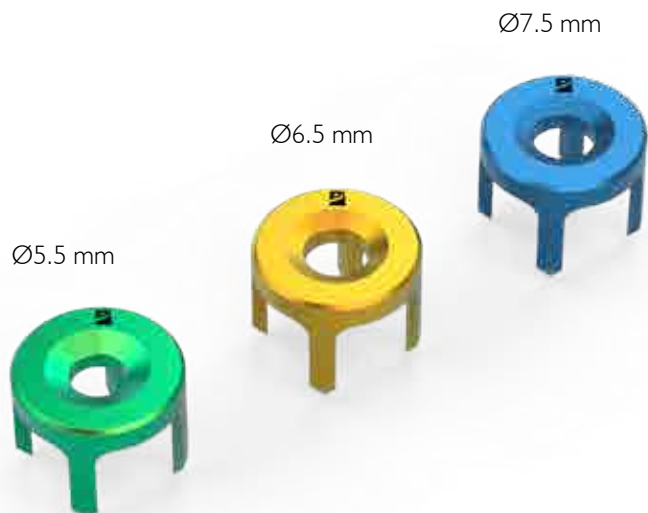

Código Code Código	Diâmetro Diameter Diámetro
945.040	Ø5.5 mm
945.041	Ø6.5 mm
945.042	Ø7.5 mm

CONECTOR DE BARRA Ø6.0 x Ø6.0 mm
 Ø6.0 x Ø6.0 mm ROD CONNECTOR
 CONECTOR DE BARRA Ø6.0 x Ø6.0 mm



Código
 Code
 Código

940.660

GANCHO LAMINAR DESLOCADO
 DISPLACED LAMINAR HOOK
 GANCHO LAMINAR DESPLAZADO



Código Code Código	Tamaño Size Tamaño	Descrição Description Descripción
940.141	Pequeno Small Pequeño	Direito Right Derecho
940.142		Esquerdo Left Izquierdo
940.143	Grande Large Grande	Direito Right Derecho
940.144		Esquerdo Left Izquierdo

PARAFUSO BLOQUEADOR Ø10.0 mm
 Ø10.0 mm LOCKING SCREW
 TORNILLO BLOQUEADOR Ø10.0 mm



Código
 Code
 Código

940.002

BARRA Ø6.0 mm
 Ø6.0 mm ROD
 BARRA Ø6.0 mm



Código Code Código	Comprimento Length Largo
940.099	40 mm
940.100	50 mm
940.101	60 mm
940.102	70 mm
940.103	80 mm
940.104	90 mm
940.105	100 mm
940.106	110 mm
940.107	120 mm
940.108	130 mm
940.109	150 mm
940.110	160 mm

Código Code Código	Comprimento Length Largo
940.111	170 mm
940.112	180 mm
940.113	200 mm
940.114	220 mm
940.115	240 mm
940.116	260 mm
940.117	280 mm
940.118	300 mm
940.119	350 mm
940.120	400 mm
940.121	450 mm
940.122	500 mm

BARRA Ø6.0 mm COBALTO CROMO
 COBALT-CHROME Ø6.0 mm ROD
 BARRA Ø6.0 mm COBALTO-CROMO



Código Code Código	Comprimento Length Largo
945.000	40 mm
945.001	50 mm
945.002	60 mm
945.003	70 mm
945.004	80 mm
945.005	90 mm
945.006	100 mm
945.007	110 mm
945.008	120 mm
945.009	130 mm
945.010	140 mm
945.011	150 mm
945.012	160 mm

Código Code Código	Comprimento Length Largo
945.013	170 mm
945.014	180 mm
945.015	200 mm
945.016	220 mm
945.017	240 mm
945.018	260 mm
945.019	280 mm
945.020	300 mm
945.021	350 mm
945.022	400 mm
945.023	450 mm
945.024	500 mm

BARRA TRANSVERSAL Ø4.0 mm
 Ø4.0 mm TRANSVERSAL ROD
 BARRA TRANSVERSAL Ø4.0 mm



Código Code Código	Comprimento Length Largo
940.151	60 mm
940.152	70 mm
940.153	80 mm

CONTAINER
CONTAINER
ESTUCHES

951.130

Container Instrumental Neospine
Neospine Instrumental Container
Estuche Instrumentales Neospine



INSTRUMENTAL
 INSTRUMENTS
 INSTRUMENTALES



Descrição Description Descripción	Código Code Código
---	--------------------------

Torquímetro 4 Nm

Torquemeter 4 Nm

908.133

Torquímetro 4 Nm



Descrição Description Descripción	Código Code Código
---	--------------------------

Conformador de Barra

Rod Bender

951.000

Conformador de Barra



Descrição Description Descripción	Código Code Código
---	--------------------------

Distrator

Distractor

951.003

Distractor



Descrição Description Descripción	Código Code Código
---	--------------------------

Compressor

Compressor

951.004

Compresor

INSTRUMENTAL
INSTRUMENTS
INSTRUMENTALES



Descrição	Código
Description	Code
Descripción	Código

Pinça de Barra
Rod Clamp **951.008**
Pinza de Barra



Descrição	Código
Description	Code
Descripción	Código

Cabo Reto
Straight Handle **951.015**
Mango Recto



Descrição	Código
Description	Code
Descripción	Código

Chave Garfo
Rod Introducer **951.019**
Llave Tenedor



Descrição	Código
Description	Code
Descripción	Código

Alicate Espondilolistese
Spondylolisthesis Pliers **951.020**
Alicate Espondilolistesis

INSTRUMENTAL
 INSTRUMENTS
 INSTRUMENTALES



Descrição Description Descripción	Código Code Código
---	--------------------------

Chave Antitorque

Anti Torque Wrench

951.021

Llave Antitorque



Descrição Description Descripción	Código Code Código
---	--------------------------

Conformador de Barra
Direito

Right Rod Bender

951.035

Conformador de Barra
Derecho



Descrição Description Descripción	Código Code Código
---	--------------------------

Conformador de Barra
Esquerdo

Left Rod Bender

951.036

Conformador de Barra
Izquierdo



Descrição Description Descripción	Código Code Código
---	--------------------------

Preparador Pedicular

Rod Pusher

951.043

Preparador Pedicular

INSTRUMENTAL
INSTRUMENTS
INSTRUMENTALES



Descrição	Código
Description	Code
Descripción	Código

Lâmina Preparadora

Lamina Pusher **951.044**

Lamina Preparadora



Descrição	Código
Description	Code
Descripción	Código

Chave Ratchet

Ratchet Wrench **951.051**

Atornillador Ratchet



Descrição	Código
Description	Code
Descripción	Código

Rotacionador com Ajuste de Pressão

Rotator Pressure Adjustment **951.061**

Rotador con Ajuste de Presión



Descrição	Código
Description	Code
Descripción	Código

Conexão Perfurador Inicial Intercambiável

Interchangeable Initial Awl Connector **951.101**

Conexión Perforador Inicial Intercambiable

INSTRUMENTAL
 INSTRUMENTS
 INSTRUMENTALES



Descrição Description Descripción	Código Code Código
---	--------------------------

Conexão Perfurador

Interchangeable Awl
Connector

951.102

Conexión Perforador



Descrição Description Descripción	Código Code Código	Diâmetro Diameter Diámetro
---	--------------------------	----------------------------------

Conexão Macho

Interchangeable Tap
Connector

951.104 Ø5.5 mm

Conexión Macho



Descrição Description Descripción	Código Code Código	Diâmetro Diameter Diámetro
---	--------------------------	----------------------------------

Conexão Macho

Interchangeable Tap
Connector

951.105 Ø6.5 mm

Conexión Macho



Descrição Description Descripción	Código Code Código
---	--------------------------

Conexão Monofix

Monofix Connector

951.107

Conexión Monofix

INSTRUMENTAL
INSTRUMENTS
INSTRUMENTALES



Descrição	Código
Description	Code
Descripción	Código

Conexão Parafuso Bloqueador

Locking Screw Connector **951.108**

Conexión Tornillo Bloqueador



Descrição	Código
Description	Code
Descripción	Código

Conexão Sextavada
Torquímetro

Torquemeter Hexagonal
Connector **951.109**

Conexión Hexagonal
Torquímetro



Descrição	Código	Diâmetro
Description	Code	Diameter
Descripción	Código	Diámetro

Conexão Hexagonal

Hexagonal Connector **951.110** Ø3.5 mm

Conexión Hexagonal



Descrição	Código
Description	Code
Descripción	Código

Conexão Pressionador de
Barra

Rod Press Connector **951.111**

Conexión Presionador de
Barra

INSTRUMENTAL
 INSTRUMENTS
 INSTRUMENTALES



Descrição Description Descripción	Código Code Código
---	--------------------------

Torquímetro 12 Nm

T Handle Torquemeter 12 Nm **951.113**

Torquímetro 12 Nm



Descrição Description Descripción	Código Code Código
---	--------------------------

Conexão Rotacionador

Hexagonal Rod Rotator **951.120**

Conexión Rotador



Descrição Description Descripción	Código Code Código
---	--------------------------

Conexão Hexagonal Interna
7 mm

Hexagonal Internal Connector
7 mm **951.122**

Conexión Hexagonal Interna
7 mm



Descrição Description Descripción	Código Code Código
---	--------------------------

Conexão Pressionador de
Gancho

Hook Press Connector **951.123**

Conexión Presionador de
Gancho

INSTRUMENTAL
INSTRUMENTS
INSTRUMENTALES



Descrição	Código
Description	Code
Descripción	Código

Conexão Poliaxial G2
Polyaxial G2 Connector **951.125**
Conexión Poli-axial G2



Descrição	Código
Description	Code
Descripción	Código

Conexão Hexagonal 3.5 p/
Torquímetro
3.5 Hex Torquemeter 4 Nm **951.131**
Conexión Hexagonal 3.5 p/
Torquímetro



Descrição	Código
Description	Code
Descripción	Código

Probe Pediátrico 5.2
5.2 Probe PD **951.203**
Sonda Pediátrico 5.2



Descrição	Código
Description	Code
Descripción	Código

Macho Ø4.5 mm Pediátrico
Tap Ø4.5 mm PD **951.207**
Macho Ø4.5 mm Pediátrico

INSTRUMENTAL
 INSTRUMENTS
 INSTRUMENTALES



Descrição	Código
Description	Code
Descripción	Código

Marcador Pedicular Direito

Right Pedicle Marker **951.220**

Marcador Pedicular Derecho



Descrição	Código
Description	Code
Descripción	Código

Marcador Pedicular Esquerdo

Left Pedicle Marker **951.221**

Marcador Pedicular Izquierdo



Descrição	Código
Description	Code
Descripción	Código

Rod Persuader

Rod Persuader **951.222**

Rod Persuader



Descrição	Código	Diâmetro
Description	Code	Diameter
Descripción	Código	Diámetro

Template

Template **951.224** Ø5.2 mm

Template

INSTRUMENTAL
INSTRUMENTS
INSTRUMENTALES

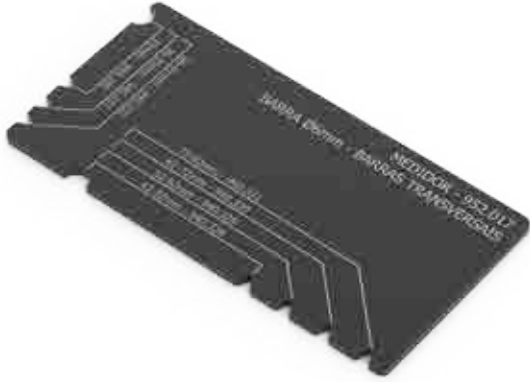

Descrição Description Descripción	Código Code Código
---	--------------------------

Medidor para Barra
Transversal

Transversal Rod Measurer **952.017**

Medidor para Barra
Transversal

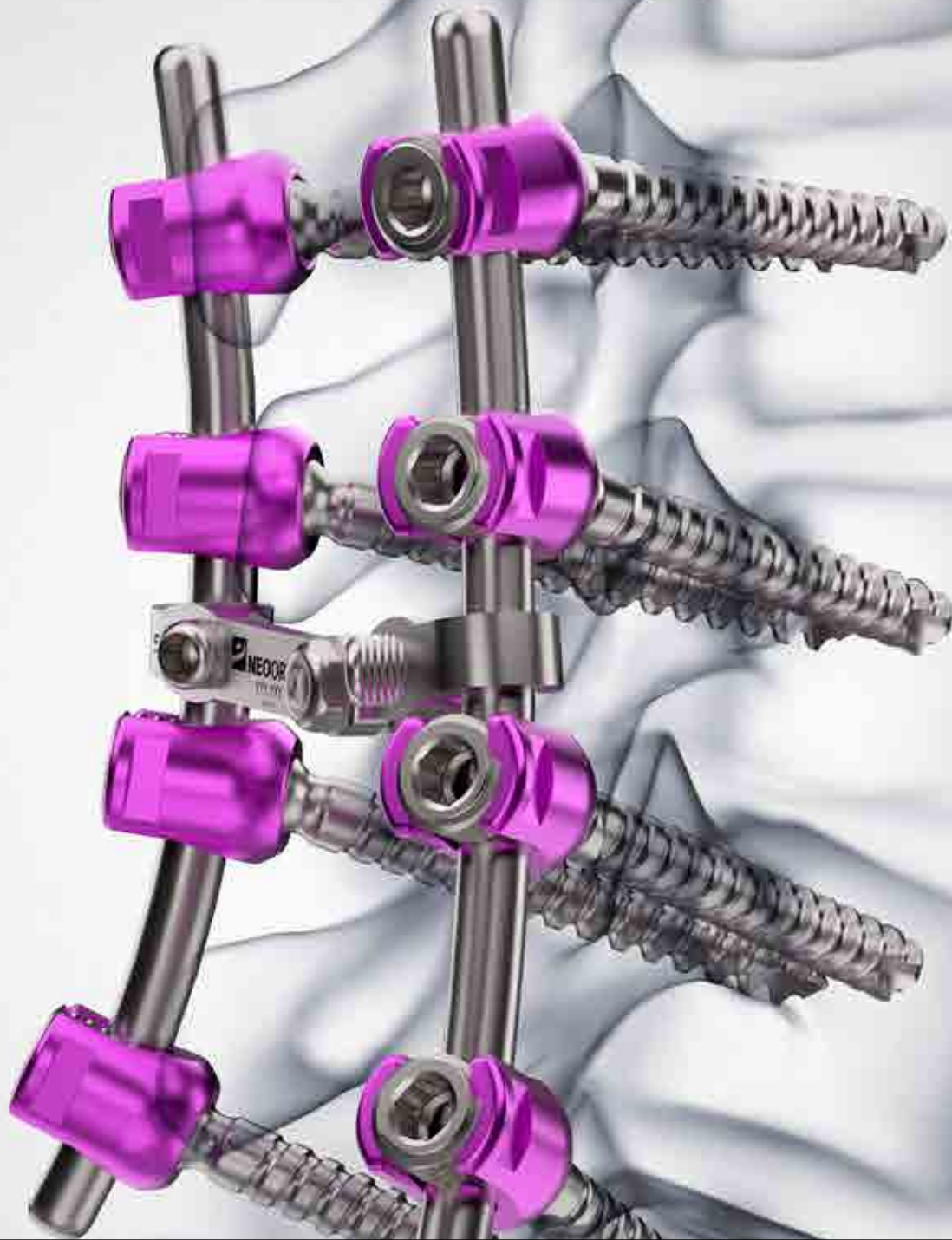

NEOSPINE - PEDICULAR PEDIÁTRICO

NEOSPINE - PEDIATRIC PEDICULAR

NEOSPINE - PEDICULAR PEDIÁTRICO

CONTAINER
CONTAINER
ESTUCHES

951.201

Container Implantes Neospine Pediátrico
Pediatric Neospine Implants Container
Estuche Implantes Neospine Pediátrico

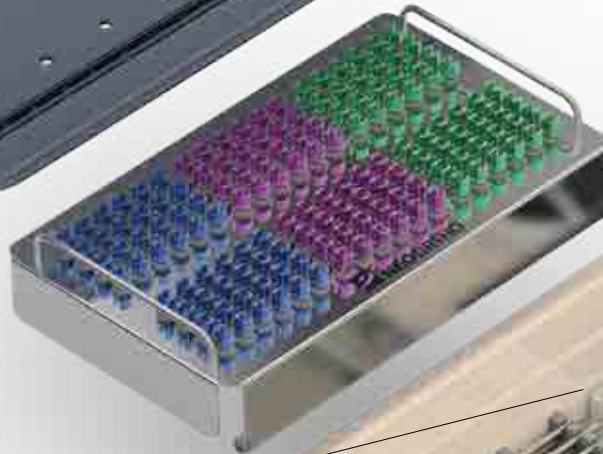

951.219

Box Implantes Pediátricos
Pediatric Implants Box
Caja Implantes Pediátricos



951.029

Box Alojamento Parafuso Bloqueador Neospine
Neospine Locking Screw Box
Caja Tornillo Bloqueador Neospine

951.299

Conjunto do Container com Implantes e Instrumental
Container with Implant and Instruments Set
Conjunto del Estuche con Implantes e Instrumentales

PARAFUSOS MONOAXIAL - PEDIÁTRICO
 MONO-AXIAL SCREW - PEDIATRIC
 TORNILLOS MONOAXIAL - PEDIÁTRICO



	Ø 3.5 mm	Ø 4.5 mm	Ø 5.5 mm
25 mm	943.012	943.015	•
30 mm	943.013	943.016	943.018
35 mm	943.014	943.017	943.019
40 mm	•	•	943.020
45 mm	•	•	943.021

PARAFUSOS PEDICULAR POLIAXIAL - PEDIÁTRICO
 POLYAXIAL PEDICULAR SCREW - PEDIATRIC
 TORNILLOS PEDICULAR POLIAXIAL - PEDIÁTRICO



	Ø 3.5 mm	Ø 4.5 mm	Ø 5.5 mm
25 mm	943.002	943.005	•
30 mm	943.003	943.006	943.008
35 mm	943.004	943.007	943.009
40 mm	•	•	943.010
45 mm	•	•	943.011

BARRA TRANSVERSAL FLEXÍVEL
 TRANSVERSAL FLEXIBLE ROD
 BARRA TRANSVERSAL FLEXIBLE



Código Code Código	Comprimento Length Largo
943.054	30 - 35 mm
943.055	36 - 41 mm
943.056	42 - 52 mm
943.057	52 - 62 mm
943.058	62 - 72 mm

BARRA TRANSVERSAL FIXA
 TRANSVERSAL FIXED ROD
 BARRA TRANSVERSAL FIJA



Código Code Código	Comprimento Length Largo
943.064	20 mm
943.065	24 mm
943.066	28 mm
943.067	32 mm
943.068	36 mm
943.069	40 mm

CONECTOR PARALELO
PARALLEL CONNECTOR
CONECTOR PARALELO



Código Code Código	Diámetro Diameter Diámetro
943.072	Ø5.3 mm x Ø5.3 mm
943.073	Ø5.3 mm x Ø6.0 mm

BARRA Ø5.2 mm
Ø5.2 mm ROD
BARRA Ø5.2 mm



Código Code Código	Comprimento Length Largo	Código Code Código	Comprimento Length Largo
943.030	40 mm	943.042	170 mm
943.031	50 mm	943.043	180 mm
943.032	60 mm	943.044	200 mm
943.033	70 mm	943.045	220 mm
943.034	80 mm	943.046	240 mm
943.035	90 mm	943.047	260 mm
943.036	100 mm	943.048	280 mm
943.037	110 mm	943.049	300 mm
943.038	120 mm	943.050	350 mm
943.039	130 mm	943.051	400 mm
943.040	150 mm	943.052	450 mm
943.041	160 mm	943.053	500 mm

PARAFUSO BLOQUEADOR Ø8 mm
Ø8 mm LOCKING SCREW
TORNILLO BLOQUEADOR Ø8 mm



Código
Code
Código

943.063

GANCHO
HOOK
GANCHO

943.062

Pedicular



943.061

Laminar



943.060

Torácico Curto
Thoracic Short
Torácico Corto



CONTAINER
CONTAINER
ESTUCHES

951.200

Container Instrumental Neospine Pediátrico
Pediatric Neospine Instrumental Container
Estuche Instrumentales Neospine Pediátrico



INSTRUMENTAL
 INSTRUMENTS
 INSTRUMENTALES



Descrição	Código
Description	Code
Descripción	Código

Conformador de Barra
 Rod Bender **951.000**
 Conformador de Barra



Descrição	Código
Description	Code
Descripción	Código

Distractor
 Distractor **951.003**
 Distractor



Descrição	Código
Description	Code
Descripción	Código

Compressor
 Compressor **951.004**
 Compresor



Descrição	Código
Description	Code
Descripción	Código

Cabo Reto
 Straight Handle **951.015**
 Mango Recto

INSTRUMENTAL
INSTRUMENTS
INSTRUMENTALES



Descrição	Código
Description	Code
Descripción	Código

Conformador de Barra
Direito

Right Rod Bender **951.035**

Conformador de Barra
Derecho



Descrição	Código
Description	Code
Descripción	Código

Conformador de Barra
Esquerdo

Left Rod Bender **951.036**

Conformador de Barra
Izquierdo



Descrição	Código
Description	Code
Descripción	Código

Chave Ratchet

Ratchet Wrench **951.051**

Atornillador Ratchet



Descrição	Código
Description	Code
Descripción	Código

Rotacionador com Ajuste de
Pressão

Rotator Pressure Adjustment **951.061**

Rotador con Ajuste de Presión

INSTRUMENTAL
 INSTRUMENTS
 INSTRUMENTALES



Descrição Description Descripción	Código Code Código	Diâmetro Diameter Diámetro
---	--------------------------	----------------------------------

Conexão Hexagonal

Hexagonal Connector **951.110** Ø 3.5 mm

Conexión Hexagonal



Descrição Description Descripción	Código Code Código
---	--------------------------

Conexão Pressionador de Barra

Rod Press Connector **951.111**

Conexión de Presionar Barra



Descrição Description Descripción	Código Code Código
---	--------------------------

Torquímetro 12 Nm

T Handle Torquemeter 12 Nm **951.113**

Torquimetro 12 Nm



Descrição Description Descripción	Código Code Código
---	--------------------------

Conexão Rotacionador

Hexagonal Rod Rotator **951.120**

Conexión Rotador

INSTRUMENTAL
INSTRUMENTS
INSTRUMENTALES



Descrição
Description
Descripción

Código
Code
Código

Conexão Hexagonal Interna
7 mm

Hexagonal Internal Connector
7 mm **951.122**

Conexión Hexagonal Interna
7 mm



Descrição
Description
Descripción

Código
Code
Código

Conexão Hexagonal 3.5 p/
Torquímetro

3.5 Hex Connection
Torquemeter 4 Nm **951.131**

Conexión Hexagonal 3.5 p/
Torquímetro



Descrição
Description
Descripción

Código
Code
Código

Probe Pediátrico

Probe Pediatric **951.203**

Sonda Pediátrico



Descrição
Description
Descripción

Código
Code
Código

Probe Pediátrico Angulado

Angled Probe Pediatric **951.204**

Sonda Pediátrica Angulada

INSTRUMENTAL
 INSTRUMENTS
 INSTRUMENTALES



Descrição Description Descripción	Código Code Código
---	--------------------------

Chave Anti Torque Pediátrica

Pediatric Anti Torque Wrench

951.205

Atornillador Antitorque
Pediátrico



Descrição Description Descripción	Código Code Código	Diâmetro Diameter Diámetro
---	--------------------------	----------------------------------

Macho Pediátrico

Tap Pediatric

951.206 Ø 3.5 mm

Macho Pediátrico



Descrição Description Descripción	Código Code Código	Diâmetro Diameter Diámetro
---	--------------------------	----------------------------------

Macho Pediátrico

Tap Pediatric

951.207 Ø 4.5 mm

Macho Pediátrico



Descrição Description Descripción	Código Code Código
---	--------------------------

Pressionador de Gancho
Pediátrico

Hook Press Pediatric

951.208

Pressionador de Gancho
Pediátrico

INSTRUMENTAL
INSTRUMENTS
INSTRUMENTALES



Descrição
Description
Descripción

Código
Code
Código

Lamina Preparadora Pediátrico

Rod Pusher Pediatric **951.209**

Lamina Preparadora Pediátrico



Descrição
Description
Descripción

Código
Code
Código

Preparador Pedicular
Pediátrico

Rod Pusher Pediatric **951.210**

Preparador Pedicular
Pediátrico



Descrição
Description
Descripción

Código
Code
Código

Perfurador Inicial Pediátrico

Initial Awl Pediatric **951.213**

Perforador Inicial Pediátrico



Descrição
Description
Descripción

Código
Code
Código

Conexão Bloqueador
Pediátrico

Locking Screw Pediatric
Connector **951.214**

Conexión Bloqueador
Pediátrico

INSTRUMENTAL
 INSTRUMENTS
 INSTRUMENTALES



Descrição Description Descripción	Código Code Código
---	--------------------------

Conexão Monofix Pediátrico

Monofix Pediatric Connector **951.215**

Conexión Monofix Pediátrico



Descrição Description Descripción	Código Code Código
---	--------------------------

Conexão Torquímetro
Pediátrico

Torquemeter Connector
Pediatric **951.216**

Conexión Torquímetro
Pediátrico



Descrição Description Descripción	Código Code Código
---	--------------------------

Pinça de Barra Pediátrico

Rod Holder Pediatric **951.217**

Pinza de Barra Pediátrico



Descrição Description Descripción	Código Code Código
---	--------------------------

Chave Garfo Pediátrico

Rod Introducer Pediatric **951.218**

Atornillador Tenedor
Pediátrico

INSTRUMENTAL
INSTRUMENTS
INSTRUMENTALES



Descrição	Código
Description	Code
Descripción	Código

Marcador Pedicular Direito
Right Pedicle Marker **951.220**

Marcador Pedicular Derecho



Descrição	Código
Description	Code
Descripción	Código

Marcador Pedicular Esquerdo
Left Pedicle Marker **951.221**

Marcador Pedicular Izquierdo



Descrição	Código
Description	Code
Descripción	Código

Rod Persuader
Rod Persuader **951.222**

Rod Persuader



Descrição	Código
Description	Code
Descripción	Código

Conexão Polifix Pediátrico
Pediatric Polifix Connection **951.223**

Conexión Polifix Pediátrico

INSTRUMENTAL
 INSTRUMENTS
 INSTRUMENTALES



Descrição Description Descripción	Código Code Código	Diâmetro Diameter Diámetro
---	--------------------------	----------------------------------

Template

Template **951.224** Ø5.2 mm

Template



Descrição Description Descripción	Código Code Código	Diâmetro Diameter Diámetro
---	--------------------------	----------------------------------

Perfurador Pediátrico Cabo
 Pera

Tear Drop Awl Pediatric **951.225** Ø3.5 mm

Perfurador Pediátrico Mango
 Pera



Descrição Description Descripción	Código Code Código	Diâmetro Diameter Diámetro
---	--------------------------	----------------------------------

Perfurador Pediátrico Cabo
 Pera

Tear Drop Awl Pediatric **951.226** Ø4.5 mm

Perfurador Pediátrico Mango
 Pera



Descrição Description Descripción	Código Code Código
---	--------------------------

Medidor para Barra
 Transversal

Transversal Rod Measurer **952.017**

Medidor para Barra
 Transversal

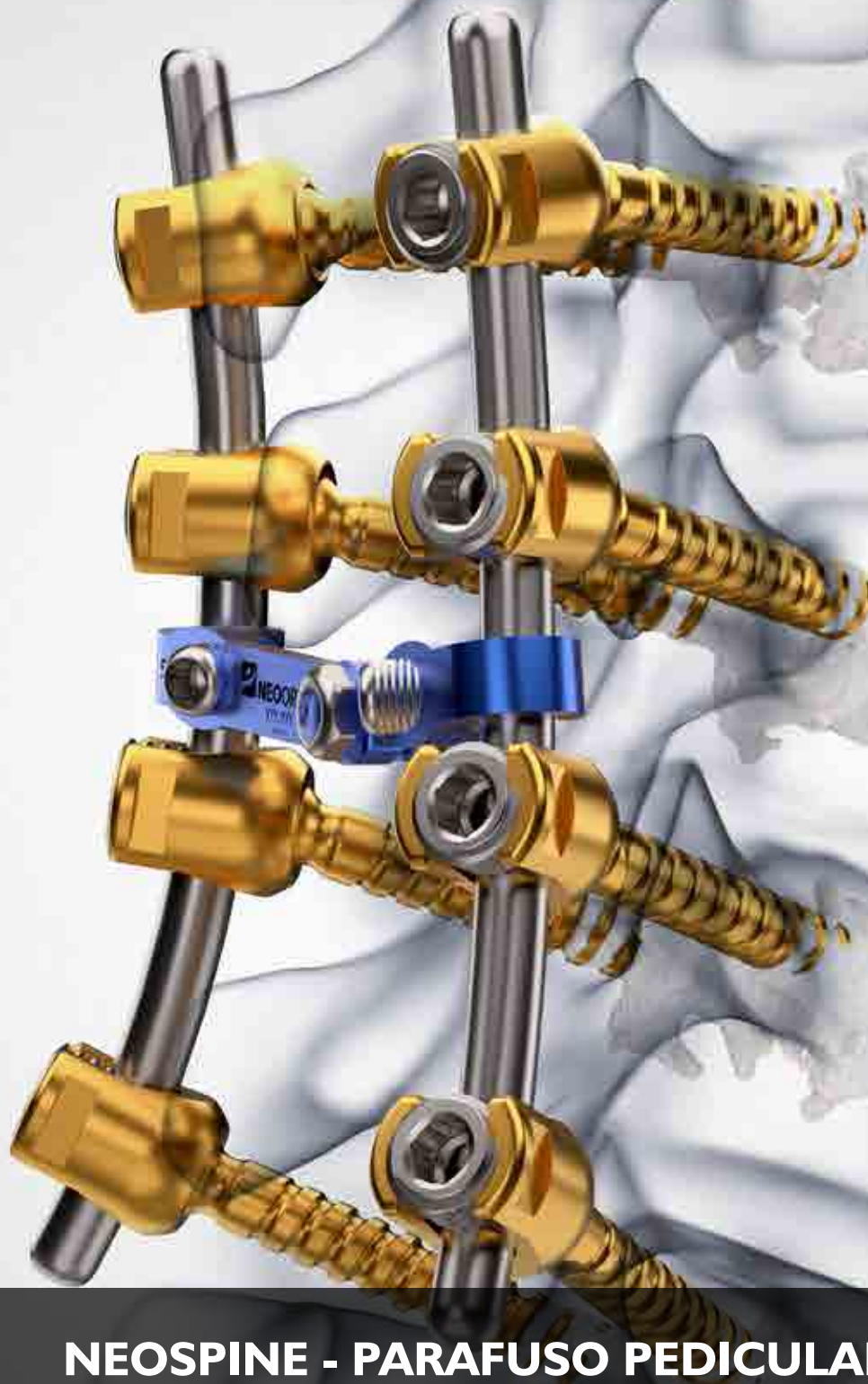

NEOSPINE - PARAFUSO PEDICULAR CANULADO

NEOSPINE - CANNULATED PEDICULAR SCREW

NEOSPINE - TORNILLO PEDICULAR CANULADO

CONTAINER
CONTAINER
ESTUCHES

951.052

Container Termoformado Implantes
Implants Thermoformed Container
Estuche Termoformado Implantes



951.058

Conjunto do Container com Implantes
Container with Implant Set
Conjunto del Estuche con Implantes

PARAFUSO PEDICULAR POLIAXIAL CANULADO G2
 CANNULATED POLYAXIAL PEDICULAR SCREW G2
 TORNILLO PEDICULAR POLIAXIAL CANULADO G2



	Ø 6.5 mm	Ø 7.5 mm
30 mm	940.451	940.459
35 mm	940.452	940.460
40 mm	940.453	940.461
45 mm	940.454	940.462
50 mm	940.455	940.463
55 mm	940.456	940.464
60 mm	940.457	940.465

BARRA TRANSVERSAL FLEXÍVEL
 TRANSVERSAL FLEXIBLE ROD
 BARRA TRANSVERSAL FLEXIBLE



Código Code Código	Comprimento Length Largo
940.333	30 - 35 mm
940.332	36 - 41 mm
940.328	42 - 52 mm
940.329	52 - 62 mm
940.330	62 - 72 mm
940.331	72 - 82 mm

BARRA TRANSVERSAL FIXA
 FIXED TRANSVERSAL ROD
 BARRA TRANSVERSAL FIJA



Código Code Código	Comprimento Length Largo
940.185	25 mm
940.186	30 mm
940.187	35 mm
940.188	40 mm
940.189	45 mm

CONECTOR AXIAL
AXIAL CONNECTOR
CONECTOR AXIAL



Código
Code
Código

940.140

PARAFUSO BLOQUEADOR Ø 10.0 mm
Ø 10.0 mm LOCKING SCREW
TORNILLO BLOQUEADOR Ø 10.0 mm



Código
Code
Código

940.002

GANCHO
HOOK
GANCHO

940.133

Pedicular



940.132

Laminar



940.130

Torácico Curto
Short Thoracic
Torácico Corto



940.135

Laminar Esquerdo
Left Laminar
Laminar Izquierdo

940.134

Laminar Direito
Right Laminar
Laminar Derecho

940.131

Torácico Longo
Long Thoracic
Torácico Largo



940.150

Conector Transversal
Transversal Connector
Conector Transversal

GANCHO DESLOCADO
OFFSET HOOK
GANCHO DESPLAZADO



Código Code Código	Tamanho Size Tamaño	Descrição Description Descripción
940.141	Pequeno Small Pequeño	Direito Right Derecho
940.142		Esquerdo Left Izquierdo
940.143	Grande Large Grande	Direito Right Derecho
940.144		Esquerdo Left Izquierdo

BARRA Ø 6.0 mm
 Ø 6.0 mm ROD
 BARRA Ø 6.0 mm



Código Code Código	Comprimento Length Largo
940.099	40 mm
940.100	50 mm
940.101	60 mm
940.102	70 mm
940.103	80 mm
940.104	90 mm
940.105	100 mm
940.106	110 mm
940.107	120 mm
940.108	130 mm
940.109	150 mm
940.110	160 mm

Código Code Código	Comprimento Length Largo
940.111	170 mm
940.112	180 mm
940.113	200 mm
940.114	220 mm
940.115	240 mm
940.116	260 mm
940.117	280 mm
940.118	300 mm
940.119	350 mm
940.120	400 mm
940.121	450 mm

BARRA TRANSVERSAL Ø 4.0 mm
 Ø 4.0 mm TRANSVERSAL ROD
 BARRA TRANSVERSAL Ø 4.0 mm



Código Code Código	Comprimento Length Largo
940.151	60 mm
940.152	70 mm
940.153	80 mm

CONTAINER
CONTAINER
ESTUCHES

951.130

Container Instrumental Neospine
Neospine Instrumental Container
Estuche Instrumentales Neospine



951.059

Conjunto do Container com Instrumental
Container with Instruments Set
Conjunto del Estuche con Instrumentales

INSTRUMENTAL
INSTRUMENTS
INSTRUMENTALES



Descrição	Código
Description	Code
Descripción	Código

Torquímetro 4 Nm

Torquemeter 4 Nm **908.133**

Torquimetro 4 Nm

Descrição	Código	Ø x Comprimento
Description	Code	Ø x Length
Descripción	Código	Ø x Largo



Fio Guia

Guide Wire **919.002** Ø1.5 x 250 mm

Hilo Guía

Descrição	Código
Description	Code
Descripción	Código



Conformador de Barra

Rod Bender **951.000**

Conformador de Barra

Descrição	Código
Description	Code
Descripción	Código



Distrator

Distractor **951.003**

Distractor

INSTRUMENTAL
 INSTRUMENTS
 INSTRUMENTALES



Descrição Description Descripción	Código Code Código
---	--------------------------

Compressor

Compressor **951.004**

Compresor



Descrição Description Descripción	Código Code Código
---	--------------------------

Pinça de Barra

Rod Clamp **951.008**

Pinza de Barra



Descrição Description Descripción	Código Code Código
---	--------------------------

Cabo Reto

Straight Handle **951.015**

Mango Recto



Descrição Description Descripción	Código Code Código
---	--------------------------

Chave Garfo

Rod Introducer **951.019**

Llave Tenedor

INSTRUMENTAL
INSTRUMENTS
INSTRUMENTALES



Descrição	Código
Description	Code
Descripción	Código

Alicate Espondilolistese
Spondylolisthesis Pliers **951.020**
Alicate Espondilolistesis



Descrição	Código
Description	Code
Descripción	Código

Chave Antitorque
Anti Torque Wrench **951.021**
Atornillador Antitorque



Descrição	Código
Description	Code
Descripción	Código

Conformador de Barra Direito
Right Rod Bender **951.035**
Conformador de Barra Derecho



Descrição	Código
Description	Code
Descripción	Código

Conformador de Barra Esquerdo
Left Rod Bender **951.036**
Conformador de Barra Izquierdo

INSTRUMENTAL
 INSTRUMENTS
 INSTRUMENTALES



Descrição Description Descripción	Código Code Código
---	--------------------------

Preparador Pedicular

Rod Pusher

951.043

Preparador Pedicular



Descrição Description Descripción	Código Code Código
---	--------------------------

Lâmina Preparadora

Lamina Pusher

951.044

Lamina Preparadora



Descrição Description Descripción	Código Code Código
---	--------------------------

Chave Ratchet

Ratchet Wrench

951.051

Atornillador Ratchet



Descrição Description Descripción	Código Code Código
---	--------------------------

Rotacionador com Ajuste de Pressão

Rotator Pressure Adjustment

951.061

Rotador con Ajuste de Presión

INSTRUMENTAL
INSTRUMENTS
INSTRUMENTALES



Descrição Description Descripción	Código Code Código
---	--------------------------

Conexão Perfurador Inicial
Intercambiável

Interchangeable Initial Awl
Connector **951.101**

Conexión Perforador Inicial
Intercambiable



Descrição Description Descripción	Código Code Código
---	--------------------------

Conexão Perfurador

Interchangeable Awl
Connector **951.102**

Conexión Perforador



Descrição Description Descripción	Código Code Código	Diâmetro Diameter Diámetro
---	--------------------------	----------------------------------

Conexão Macho

Interchangeable Tap
Connector **951.104** Ø 5.5 mm

Conexión Macho



Descrição Description Descripción	Código Code Código	Diâmetro Diameter Diámetro
---	--------------------------	----------------------------------

Conexão Macho

Interchangeable Tap
Connector **951.105** Ø 6.5 mm

Conexión Macho

INSTRUMENTAL
 INSTRUMENTS
 INSTRUMENTALES



Descrição	Código
Description	Code
Descripción	Código

Conexão Monofix
 Monofix Connector **951.107**
 Conexión Monofix



Descrição	Código
Description	Code
Descripción	Código

Conexão Parafuso Bloqueador
 Locking Screw Connector **951.108**
 Conexión Tornillo Bloqueador



Descrição	Código
Description	Code
Descripción	Código

Conexão Sextavada
 Torquímetro
 Torquemeter Hexagonal
 Connector **951.109**
 Conexión Hexagonal
 Torquímetro



Descrição	Código	Diâmetro
Description	Code	Diameter
Descripción	Código	Diámetro

Conexão Hexagonal
 Hexagonal Connector **951.110** Ø 3.5 mm
 Conexión Hexagonal

INSTRUMENTAL
INSTRUMENTS
INSTRUMENTALES



Descrição	Código
Description	Code
Descripción	Código

Conexão Pressionador de
Barra

Rod Press Connector

951.111

Conexión de Presionar Barra



Descrição	Código
Description	Code
Descripción	Código

Torquímetro 12 Nm

T Handle Torquemeter
12 Nm

951.113

Torquímetro 12 Nm



Descrição	Código
Description	Code
Descripción	Código

Conexão Rotacionador

Hexagonal Rod Rotator

951.120

Conexión Rotador



Descrição	Código
Description	Code
Descripción	Código

Conexão Hexagonal Interna
7 mm

Hexagonal Internal Connector
7 mm

951.122

Conexión Hexagonal Interna
7 mm

INSTRUMENTAL
 INSTRUMENTS
 INSTRUMENTALES



Descrição Description Descripción	Código Code Código
---	--------------------------

Conexão Pressionador de Gancho

Hook Press Connector **951.123**

Conexión de Pressionar Gancho



Descrição Description Descripción	Código Code Código
---	--------------------------

Conexão Poliaxial G2

Polyaxial G2 Connector **951.125**

Conexión Poliaxial G2



Descrição Description Descripción	Código Code Código
---	--------------------------

Conexão Hexagonal 3.5 p/
Torquímetro

3.5 Hex Connection
Torquemeter 4 Nm **951.131**

Conexión Hexagonal 3.5 p/
Torquimetro



Descrição Description Descripción	Código Code Código
---	--------------------------

Probe Pediátrico

Probe Pediatric **951.203**

Sonda Pediátrico

INSTRUMENTAL
INSTRUMENTS
INSTRUMENTALES



Descrição
Description
Descripción

Código
Code
Código

Diâmetro
Diameter
Diámetro

Macho Pediátrico

Tap Pediatric

951.207 Ø 4.5 mm

Macho Pediátrico



Descrição
Description
Descripción

Código
Code
Código

Marcador Pedicular Direito

Right Pedicle Marker

951.220

Marcador Pedicular Derecho



Descrição
Description
Descripción

Código
Code
Código

Marcador Pedicular Esquerdo

Left Pedicle Marker

951.221

Marcador Pedicular Izquierdo



Descrição
Description
Descripción

Código
Code
Código

Rod Persuader

Rod Persuader

951.222

Rod Persuader

INSTRUMENTAL
 INSTRUMENTS
 INSTRUMENTALES



Descrição Description Descripción	Código Code Código	Diâmetro Diameter Diámetro
---	--------------------------	----------------------------------

Template

Template **951.224** Ø 5.2 mm

Template

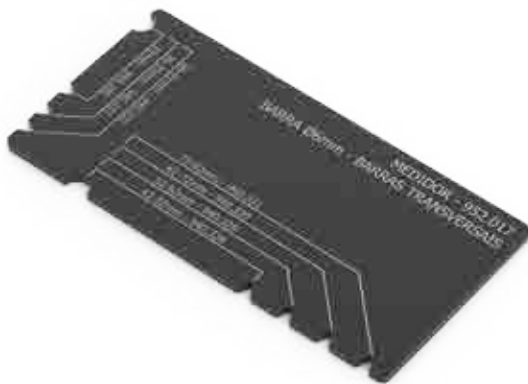

Descrição Description Descripción	Código Code Código
---	--------------------------

Medidor para Barra
 Transversal

Transversal Rod Measurer **952.017**

Medidor para Barra
 Transversal



Descrição Description Descripción	Código Code Código
---	--------------------------

Cânula

Cannula **952.201**

Cânula



Descrição Description Descripción	Código Code Código
---	--------------------------

Chave para Cânula

Cannula Wrench **952.223**

Llave para Cánula

INSTRUMENTAL
INSTRUMENTS
INSTRUMENTALES



Descrição
Description
Descripción

Código
Code
Código

Kit Aplicador de Cimento

Cement Applicator Kit

801.193

Kit Aplicador de Cemento



NEOSPINE - ESCOLIOSE

NEOSPINE - SCOLIOSIS

NEOSPINE - ESCOLIOSIS

CONTAINER
CONTAINER
ESTUCHE



951.160

Caixa de Esterilização
Sterilization Box
Caja de Esterilización

951.150

Conjunto do Container com Instrumental
Container with Instruments Set
Conjunto del Estuche con Instrumentales

INSTRUMENTAL
 INSTRUMENTS
 INSTRUMENTALES



Descrição Description Descripción	Código Code Código
---	--------------------------

Cabo Reto
 Straight Handle **951.015**
 Mango Recto



Descrição Description Descripción	Código Code Código
---	--------------------------

Conector Catraca Grande
 Large Ratchet Connector **951.151**
 Conector Trinquete Grande



Descrição Description Descripción	Código Code Código
---	--------------------------

Conector Catraca Pequeno
 Small Ratchet Connector **951.152**
 Conector Trinquete Pequeno



Descrição Description Descripción	Código Code Código
---	--------------------------

Redutor Tubular da Barra
 Tubular Rod Reducer **951.153**
 Reductor de Barra Tubular

INSTRUMENTAL
INSTRUMENTS
INSTRUMENTALES



Descrição
Description
Descripción

Código
Code
Código

Chave do Redutor Tubular

Tubular Reducer Driver **951.154**

Atornillador Reductor Tubular



Descrição
Description
Descripción

Código
Code
Código

Chave Extratora

Extracting Driver **951.155**

Atornillador Extrator



Descrição
Description
Descripción

Código
Code
Código

Conector do Parafuso de Bloqueio

Locking Screw Connector **951.156**

Conector de Tornillo de Bloqueo



Descrição
Description
Descripción

Código
Code
Código

Conector Hexagonal

Hexagonal Connector **951.157**

Conector Hexagonal

INSTRUMENTAL
 INSTRUMENTS
 INSTRUMENTALES



Descrição Description Descripción	Código Code Código
---	--------------------------

Conformador Coronal
Esquerdo

Left Coronal Bender **951.158**

Conformador Coronal
Izquierdo

Descrição Description Descripción	Código Code Código
---	--------------------------

Conformador Coronal Direito

Right Coronal Bender **951.159**

Conformador Coronal
Derecho



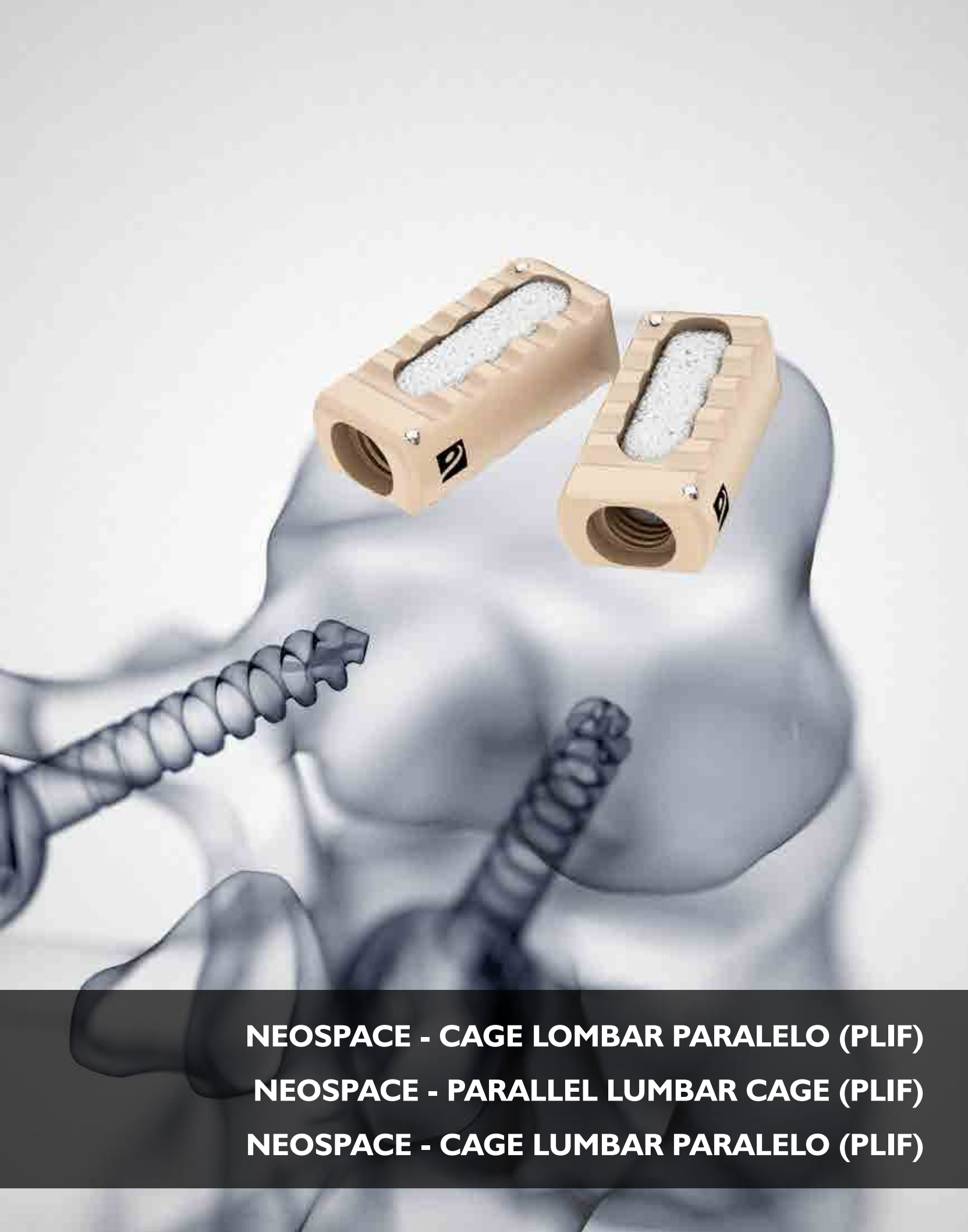

NEOSPACE - CAGE LOMBAR PARALELO (PLIF)

NEOSPACE - PARALLEL LUMBAR CAGE (PLIF)

NEOSPACE - CAGE LUMBAR PARALELO (PLIF)

CONTAINER
CONTAINER
ESTUCHES

951.336

Box Implantes Cage Lombar
Lumbar Cage Implants Box
Caja Implantes Cage Lumbar



941.799

Conjunto do Container com Implantes e Instrumental
Container with Instruments and Implants Set
Conjunto del Estuche con Implantes y Instrumentales

CAGE LOMBAR PARALELO EM PEEK
 PEEK PARALLEL LUMBAR CAGE
 CAGE LUMBAR PEEK PARALELO



Código Code Código	Comprimento Length Largo
941.700	7.0 mm
941.701	8.0 mm
941.702	9.0 mm
941.703	10.0 mm
941.704	11.0 mm
941.705	12.0 mm

CAGE LOMBAR ANGULADO EM PEEK
 PEEK ANGLED LUMBAR CAGE
 CAGE LUMBAR PEEK ANGULADO



	4°	8°
7 mm	941.710	941.720
8 mm	941.711	941.721
9 mm	941.712	941.722
10 mm	941.713	941.723
11 mm	941.714	941.724
12 mm	941.715	941.725

CONTAINER
CONTAINER
ESTUCHES

951.305

Container Instrumental Cage Lombar
Lumbar Cage Instruments Container
Estuche Instrumentales Cage Lumbar



INSTRUMENTAL
 INSTRUMENTS
 INSTRUMENTALES



Descrição Description Descripción	Código Code Código
---	--------------------------

Martelo

Hammer

919.014

Martillo

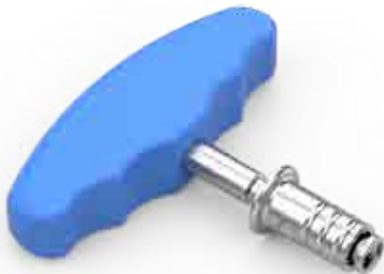

Descrição Description Descripción	Código Code Código
---	--------------------------

Cabo T

T Handle

951.002

Mango T



Descrição Description Descripción	Código Code Código
---	--------------------------

Chave Introduitora

Introducer Wrench

951.300

Atornillador Introductor



Descrição Description Descripción	Código Code Código
---	--------------------------

Compressor para Cage
Lombar

Bone Graft Compressor

951.301

Compresor para Cage
Lumbar

INSTRUMENTAL
INSTRUMENTS
INSTRUMENTALES



Descrição Description Descripción	Código Code Código
---	--------------------------

Afastador 8 mm

8 mm Retractor

951.302

Afastador 8 mm



Descrição Description Descripción	Código Code Código
---	--------------------------

Inserto do Compressor
Lombar

Lumbar Compressor Insert

951.303

Inserto do Compressor
Lumbar



Descrição Description Descripción	Código Code Código
---	--------------------------

Impactador

Lumbar Cage Impactor

951.304

Impactador



Descrição Description Descripción	Código Code Código	Comprimento Length Largo
---	--------------------------	--------------------------------

Conexão Lâmina Distratora

951.307

7 mm

951.308

8 mm

951.309

9 mm

Distractor Blade

951.310

10 mm

951.311

11 mm

Conexión Lamina Distratora

951.312

12 mm

INSTRUMENTAL
 INSTRUMENTS
 INSTRUMENTALES



Descrição Description Descripción	Código Code Código	Comprimento Length Largo
Conexão Fresa	951.316	7 mm
	951.317	8 mm
Cutter Tools	951.318	9 mm
	951.319	10 mm
Conexión Reamer	951.320	11 mm
	951.321	12 mm



Descrição Description Descripción	Código Code Código	Comprimento Length Largo
Teste Cage Lombar	951.330	7 mm
	951.331	8 mm
Lumbar Cage Test r	951.332	9 mm
	951.333	10 mm
Teste Cage Lumbar	951.334	11 mm
	951.335	12 mm

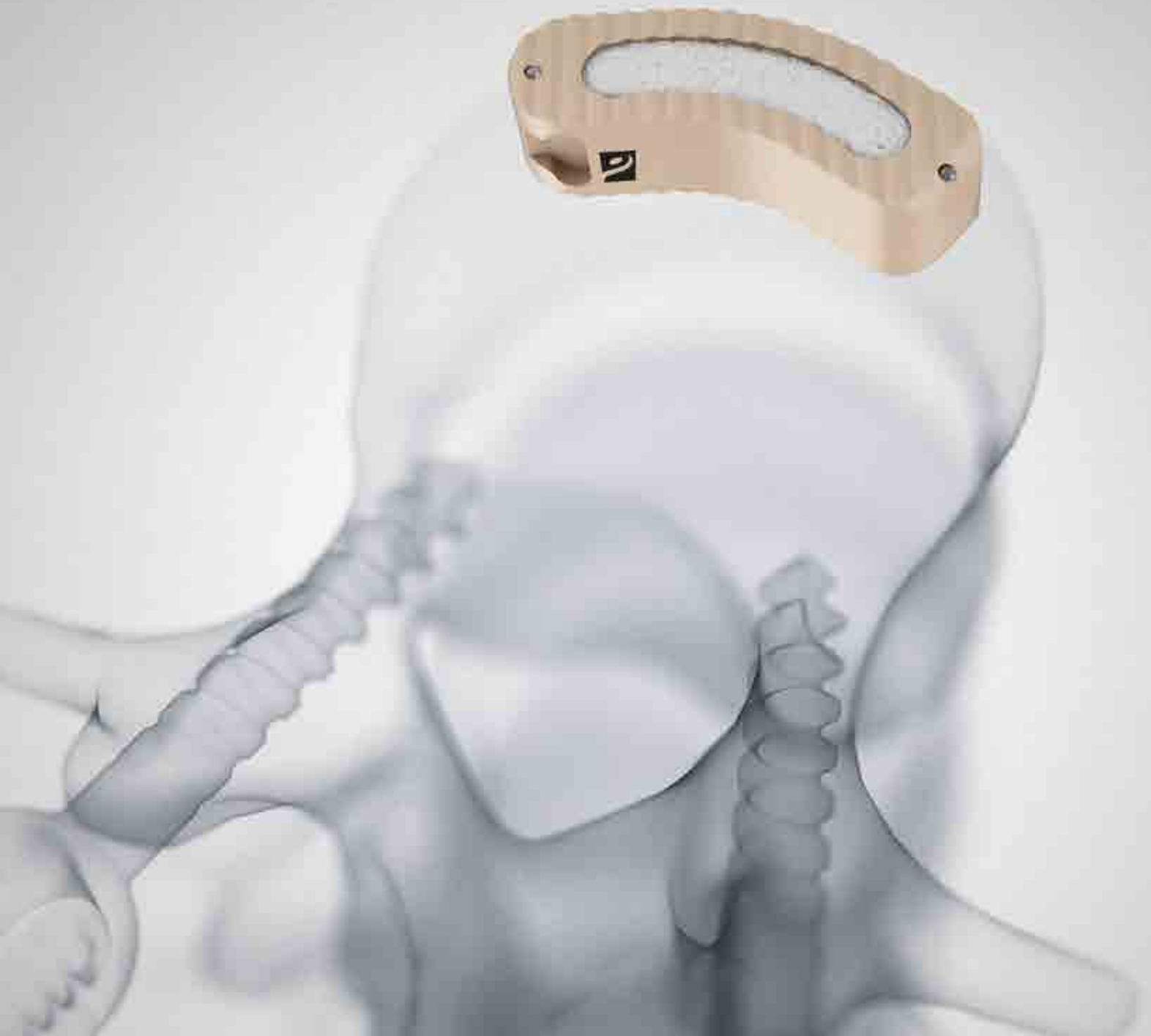

NEOSPACE - CAGE LOMBAR TRANSFORAMINAL (TLIF)

NEOSPACE - TRANSFORAMINAL LUMBAR CAGE (TLIF)

NEOSPACE - CAGE LUMBAR TRANSFORAMINAL (TLIF)

CONTAINER
CONTAINER
ESTUCHES

951.350

Container Cage Lumbar Transforaminal
Transforaminal Lumbar Cage Container
Estuche Cage Lumbar Transforaminal



941.499

Conjunto do Container com Implantes e Instrumental
Container with Instruments and Implants Set
Conjunto del Estuche con Implantes y Instrumentales

CAGE LOMBAR TRANSFORAMINAL
 TRANSFORAMINAL LUMBAR CAGE
 CAGE LUMBAR TRANSFORAMINAL



	23 mm	28 mm
7 mm	941.420	941.410
8 mm	941.421	941.411
9 mm	941.422	941.412
10 mm	941.423	941.413
11 mm	941.424	941.414
12 mm	941.425	941.415
13 mm	941.426	941.416
14 mm	941.427	941.417
15 mm	941.428	941.418
16 mm	941.429	941.419

CAGE LOMBAR TRANSFORAMINAL LORDÓTICO
 LORDOTIC TRANSFORAMINAL LUMBAR CAGE
 CAGE LUMBAR TRANSFORAMINAL LORDÓTICO



	4°	
	23 mm	28 mm
7 mm	941.430	941.400
8 mm	941.431	941.401
9 mm	941.432	941.402
10 mm	941.433	941.403
11 mm	941.434	941.404
12 mm	941.435	941.405
13 mm	●	941.406
14 mm	●	941.407
15 mm	●	941.408
16 mm	●	941.409

CONTAINER
CONTAINER
ESTUCHES

951.047

Container Complementar Cage Lombar Transforaminal
Transforaminal Lumbar Cage Complementary Container
Estuche Complementario Cage Lumbar Transforaminal



941.498

Conjunto do Container com Instrumental
Container with Instruments Set
Conjunto del Estuche con Instrumentales

INSTRUMENTAL
 INSTRUMENTS
 INSTRUMENTALES



Descrição Description Descripción	Código Code Código
---	--------------------------

Martelo

Hammer

919.014

Martillo

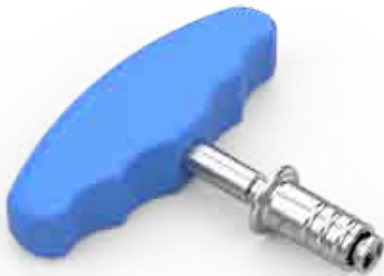

Descrição Description Descripción	Código Code Código
---	--------------------------

Cabo T

T Handle

951.002

Mango T



Descrição Description Descripción	Código Code Código
---	--------------------------

Cabo Reto

Straight Handle

951.015

Mango Recto



Descrição Description Descripción	Código Code Código
---	--------------------------

Afastador 8 mm

8 mm Retractor

951.302

Afastador 8 mm

INSTRUMENTAL
INSTRUMENTS
INSTRUMENTALES



Descrição Description Descripción	Código Code Código	Comprimento Length Largo
Raspa Angulada	951.338	7 mm
	951.339	8 mm
Angled Rasp	951.340	9 mm
	951.341	10 mm
Raspa Angular	951.342	11 mm
	951.343	12 mm



Descrição Description Descripción	Código Code Código	Comprimento Length Largo
Lâmina Distratora	951.344	7 mm
	951.345	8 mm
Distractor Blade	951.346	9 mm
	951.347	10 mm
Hoja de Distracción	951.348	11 mm
	951.349	12 mm



Descrição Description Descripción	Código Code Código
Chave Introduitora Reta TLIF	
TLIF Introducer Wrench	951.351
Atornillador Introductor Recto TLIF	



Descrição Description Descripción	Código Code Código
Impactador do Cage	
Cage Impactor	951.363
Impactador del Cage	

INSTRUMENTAL
 INSTRUMENTS
 INSTRUMENTALES



Descrição Description Descripción	Código Code Código
---	--------------------------

Impactador Angulado Cage
 TLIF

TLIF Angled Cage Impactor **951.364**

Impactador Angulado Cage
 TLIF



Descrição Description Descripción	Código Code Código
---	--------------------------

Base Compactadora de
 Enxerto

Bone Graft Compactor Base **951.365**

Base Compactadora de
 Injerto



Descrição Description Descripción	Código Code Código
---	--------------------------

Compactador de Enxerto

Bone Graft Compactor **951.366**

Compactador de Injerto



Descrição Description Descripción	Código Code Código
---	--------------------------

Raspa

Rasp **951.367**

Raspa

INSTRUMENTAL
INSTRUMENTS
INSTRUMENTALES



Descrição
Description
Descripción

Código
Code
Código

Raspa Angulada 30°

30° Angled Rasp

951.384

Raspa Angulada 30°



Descrição
Description
Descripción

Código
Code
Código

Comprimento
Length
Largo

Teste TLIF

951.385

28 x 7 mm

951.386

28 x 8 mm

TLIF Test

951.387

28 x 9 mm

951.388

28 x 10 mm

Teste TLIF

951.389

28 x 11 mm

951.390

28 x 12 mm



NEOSPACE - CAGE LOMBAR ANTERIOR (ALIF)

NEOSPACE - ANTERIOR LUMBAR CAGE (ALIF)

NEOSPACE - CAGE LUMBAR ANTERIOR (ALIF)

CONTAINER
CONTAINER
ESTUCHES

951.499

Container Cage ALIF
ALIF Cage Container
Estuche Cage ALIF

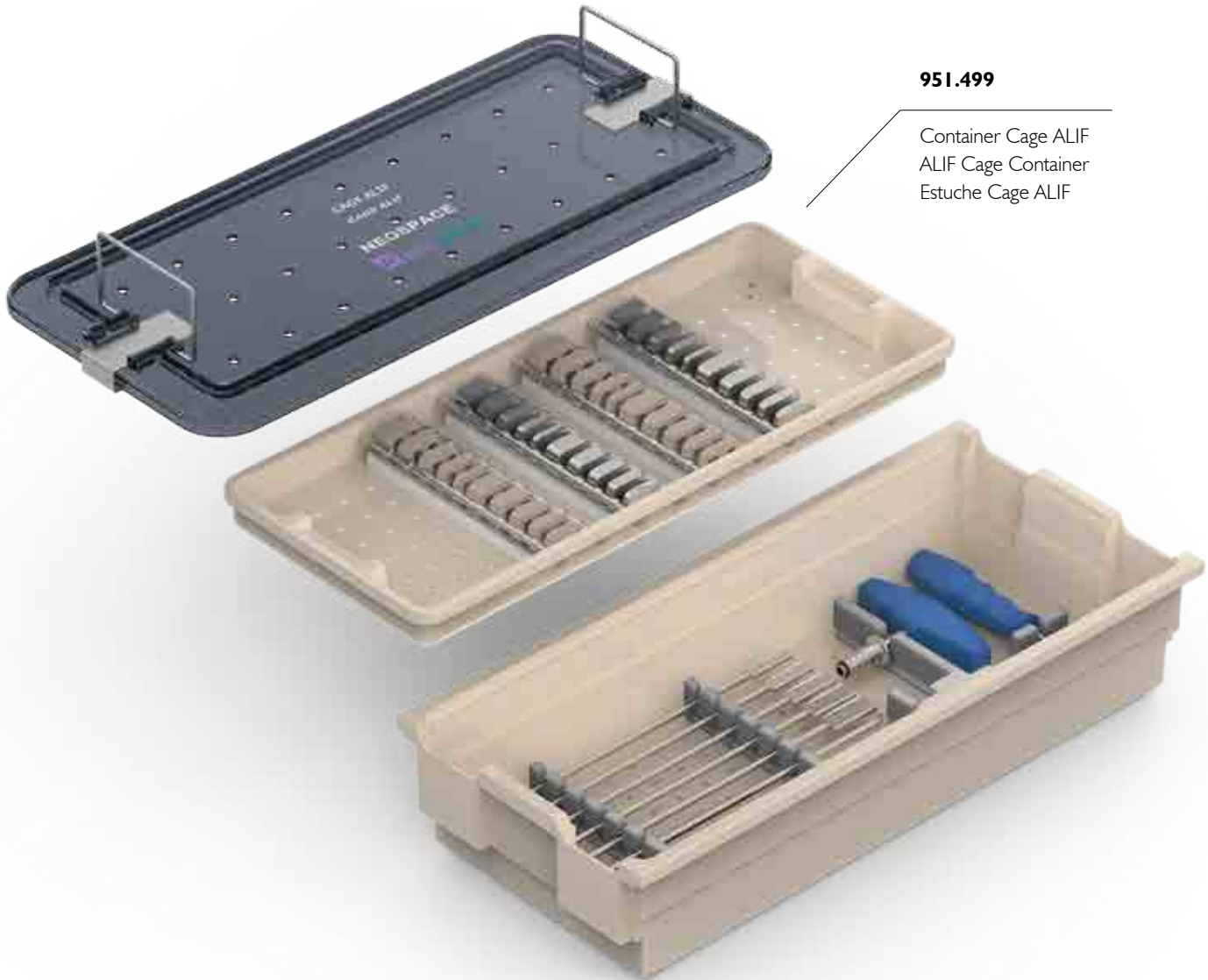

951.598 / 915.599

Conjunto do Container com Implantes e Instrumental
Container with Instruments and Implants Set
Conjunto del Estuche con Implantes y Instrumentales

CAGE ALIF PEEK
 PEEK ALIF CAGE
 CAGE ALIF PEEK



	8°		12°	
	26x31 mm	28x35 mm	26x31 mm	28x35 mm
10 mm	941.550	941.560	941.555	941.565
12 mm	941.551	941.561	941.556	941.566
14 mm	941.552	941.562	941.557	941.567
16 mm	941.553	941.563	941.558	941.568
18 mm	941.554	941.564	941.559	941.569

INSTRUMENTAL
INSTRUMENTS
INSTRUMENTALES



Descrição	Código
Description	Code
Descripción	Código

Martelo
Hammer **919.014**
Martillo

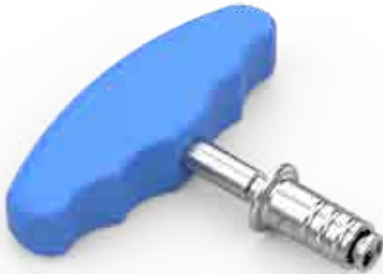

Descrição	Código
Description	Code
Descripción	Código

Cabo T
T Handle **951.002**
Mango T



Descrição	Código
Description	Code
Descripción	Código

Cabo Reto
Straight Handle **951.015**
Mango Recto



Descrição	Código
Description	Code
Descripción	Código

Raspa
Rasp **951.367**
Raspa

INSTRUMENTAL
 INSTRUMENTS
 INSTRUMENTALES



Descrição	Código
Description	Code
Descripción	Código

Chave Introduitora Cage ALIF

ALIF Introducer Wrench **951.470**

Atornillador Introductor Cage ALIF



Descrição	Código
Description	Code
Descripción	Código

Base Compactadora

Compactor Base **951.477**

Base Compactadora



Descrição	Código
Description	Code
Descripción	Código

Impactador do Cage ALIF

ALIF Cage Impactor **951.480**

Impactador do Cage ALIF



Descrição	Código	Comprimento
Description	Code	Length
Descripción	Código	Largo

Lâmina Distratora **951.494** 10 mm

951.495 12 mm

Distractor Blade **951.496** 14 mm

951.497 16 mm

Hoja de Distracción **951.498** 18 mm

INSTRUMENTAL
INSTRUMENTS
INSTRUMENTALES



Descrição Description Descripción	Código Code Código
---	--------------------------

Compactador de Enxerto

Bone Graft Compactor **951.504**

Compactador de Injerto



Descrição Description Descripción	Código Code Código	Comprimento Length Largo
---	--------------------------	--------------------------------

Teste ALIF

951.445 26 x 31 x 10 8°

951.446 26 x 31 x 12 8°

951.447 26 x 31 x 14 8°

951.448 26 x 31 x 16 8°

951.449 26 x 31 x 18 8°

ALIF Test

951.450 26 x 31 x 10 12°

951.451 26 x 31 x 12 12°

951.452 26 x 31 x 14 12°

951.453 26 x 31 x 16 12°

951.454 26 x 31 x 18 12°

Teste ALIF



Descrição Description Descripción	Código Code Código	Comprimento Length Largo
---	--------------------------	--------------------------------

Teste ALIF

951.455 28 x 35 x 10 8°

951.456 28 x 35 x 12 8°

951.457 28 x 35 x 14 8°

951.458 28 x 35 x 16 8°

951.459 28 x 35 x 18 8°

ALIF Test

951.460 28 x 35 x 10 12°

951.461 28 x 35 x 12 12°

951.462 28 x 35 x 14 12°

951.463 28 x 35 x 16 12°

951.464 28 x 35 x 18 12°

Teste ALIF

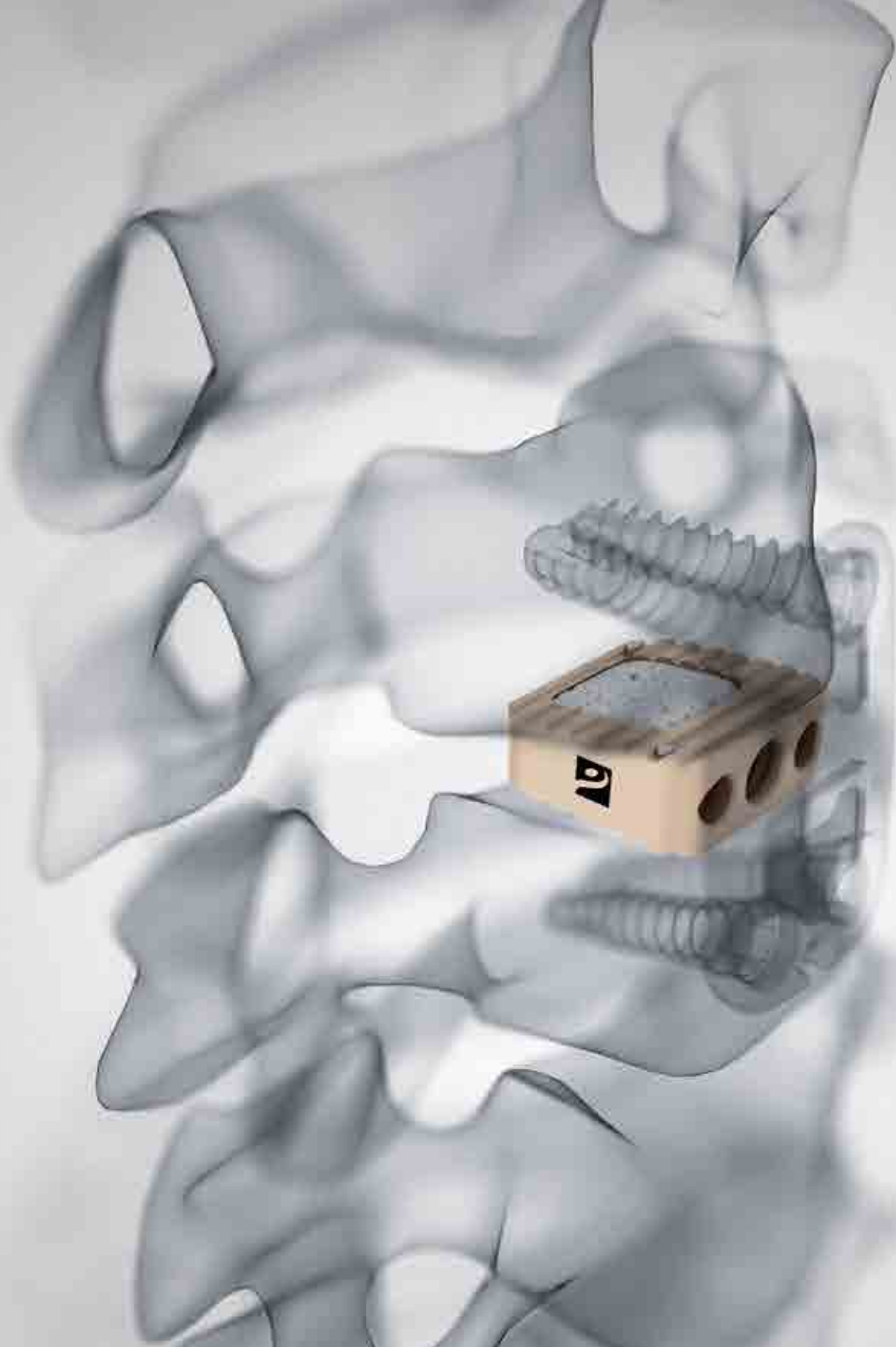

NEOSPACE - CAGE CERVICAL ANTERIOR

NEOSPACE - ANTERIOR CERVICAL CAGE

NEOSPACE - CAGE CERVICAL ANTERIOR

CONTAINER
CONTAINER
ESTUCHES

951.409

Box Cage Cervical
Cervical Cage Box
Caja Cage Cervical



941.699

Conjunto do Container com Implantes e Instrumental
Container with Instruments and Implants Set
Conjunto del Estuche con Implantes y Instrumentales

CAGE CERVICAL ANTERIOR EM PEEK
PEEK ANTERIOR CERVICAL CAGE
CAGE CERVICAL ANTERIOR EN PEEK

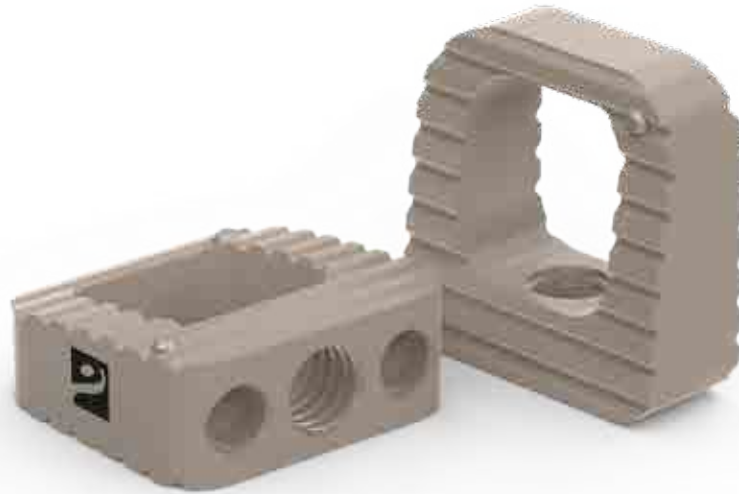

Código Code Código	Comprimento Length Largo
941.600	5.0 mm
941.601	5.5 mm
941.602	6.0 mm
941.603	6.5 mm
941.604	7.0 mm
941.605	7.5 mm

CONTAINER
CONTAINER
ESTUCHES

951.410

Container Instrumental Cage Cervical
Cervical Cage Instrumental Container
Estuche Instrumentales Cage Cervical



INSTRUMENTAL
 INSTRUMENTS
 INSTRUMENTALES



Descrição	Código
Description	Code
Descripción	Código

Martelo

Hammer

919.014

Martillo



Descrição	Código
Description	Code
Descripción	Código

Compressor Cage Cervical

Cervical Cage Compressor

951.400

Compresor Cage Cervical



Descrição	Código
Description	Code
Descripción	Código

Impactador Cage Cervical

Cervical Cage Impactor

951.401

Impactador Cage Cervical



Descrição	Código	Comprimento
Description	Code	Length
Descripción	Código	Largo

Teste Cage Cervical

951.404

5.0 mm

951.405

5.5 mm

951.406

6.0 mm

Cervical Cage Tester

951.407

6.5 mm

951.408

7.0 mm

Teste Cage Cervical

951.412

7.5 mm

INSTRUMENTAL
INSTRUMENTS
INSTRUMENTALES



Descrição
Description
Descripción

Código
Code
Código

Chave Placa Conjugada

Cage Plate Wrench

951.419

Atornillador Placa Conjugada



NEOSPACE - CAGE CERVICAL AUTOBLOQUEANTE

NEOSPACE - SELF-LOCKING CERVICAL CAGE

NEOSPACE - CAGE CERVICAL AUTOBLOQUEO

CONTAINER
CONTAINER
ESTUCHE

951.995

Box Cage Cervical Autobloqueante
Self-locking Cervical Cage Box
Caja Cage Cervical Autobloqueo

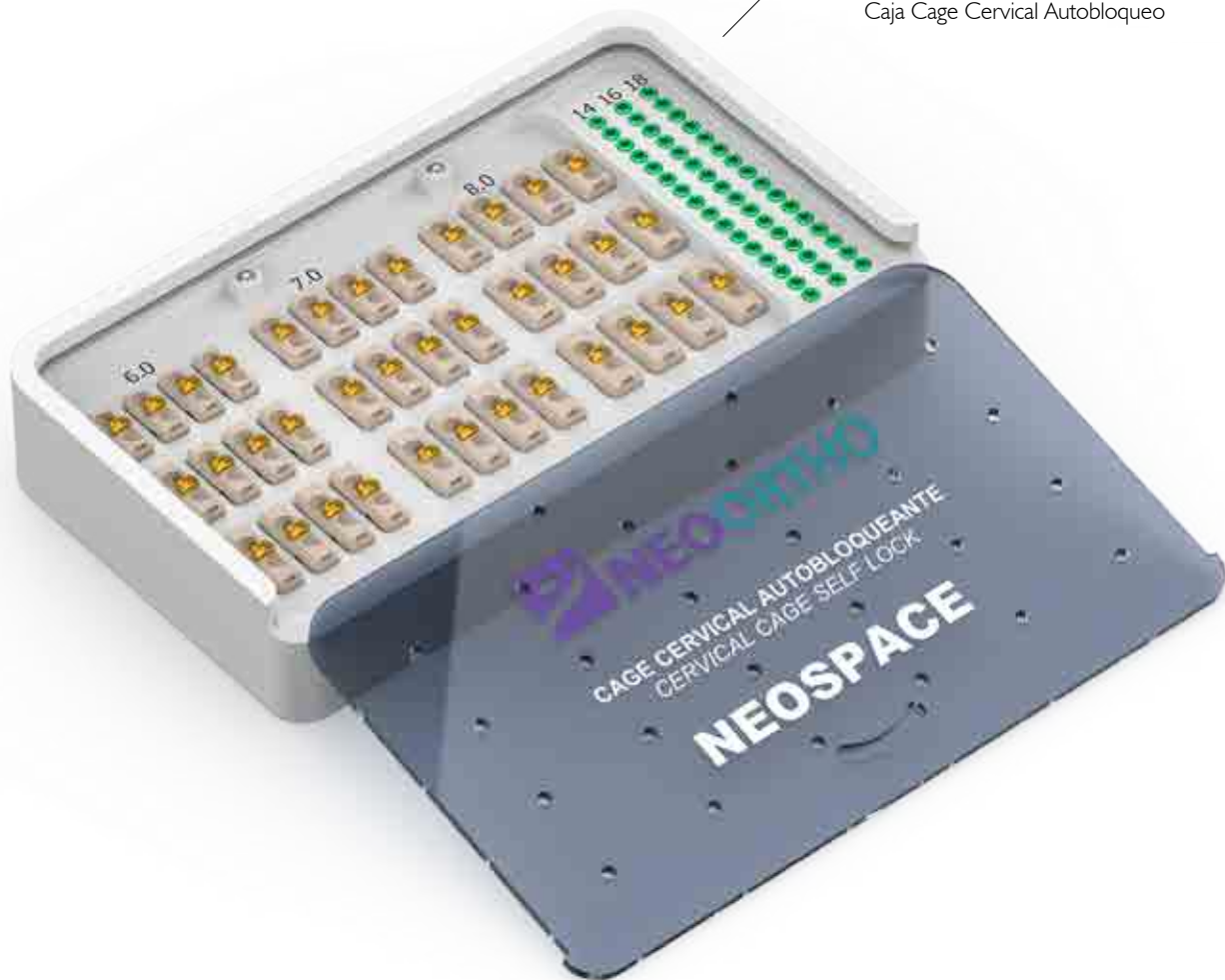

941.999

Conjunto do Container com Implantes
Container with Implants Set
Conjunto del Estuche con Implantes

CAGE CERVICAL AUTOBLOQUEANTE COM PARAFUSO
 SELF-LOCKING CERVICAL CAGE WITH SCREW
 CAGE CERVICAL AUTOBLOQUEO CON TORNILLO

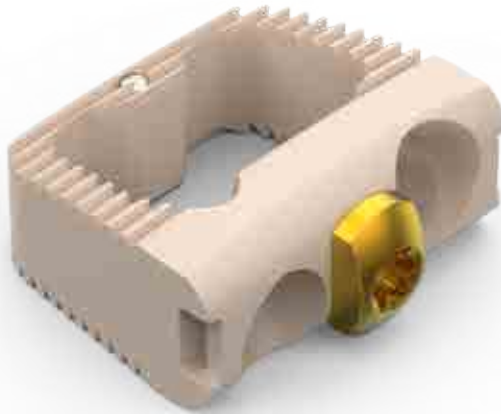

Código Code Código	Comprimento x Largura x Altura Length x Width x Height Largo x Ancho x Altura
941.950	12 x 14 x 6.0 mm
941.952	12 x 14 x 7.0 mm
941.954	12 x 14 x 8.0 mm
941.960	14 x 16 x 6.0 mm
941.962	14 x 16 x 7.0 mm
941.964	14 x 16 x 8.0 mm
941.970	15 x 18 x 6.0 mm
941.972	15 x 18 x 7.0 mm
941.974	15 x 18 x 8.0 mm

PARAFUSO PARA CAGE AUTOBLOQUEANTE Ø2.4 mm
 Ø2.4 mm SELF-LOCKING CAGE SCREW
 TORNILLO PARA CAGE AUTOBLOQUEO Ø2.4 mm

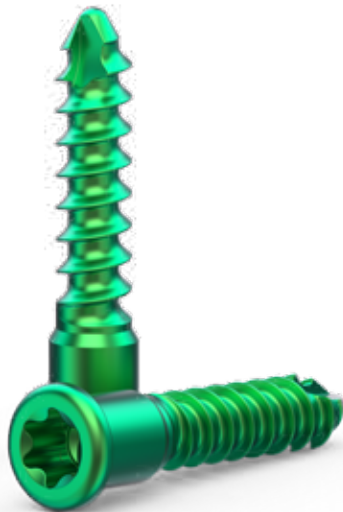

Código Code Código	Comprimento Length Largo
942.520	14 mm
942.521	16 mm
942.522	18 mm

CONTAINER
CONTAINER
ESTUCHES

951.996

Container Cage Cervical Autobloqueante
Self-locking Cervical Cage Container
Estuche Cage Cervical Autobloqueo



INSTRUMENTAL
 INSTRUMENTS
 INSTRUMENTALES



Descrição Description Descripción	Código Code Código
---	--------------------------

Chave T8

T8 Screwdriver Blade

908.141

Atornillador T8



Descrição Description Descripción	Código Code Código
---	--------------------------

Martelo

Hammer

919.014

Martillo



Descrição Description Descripción	Código Code Código
---	--------------------------

Chave de Mão 1.5 / 2.0 mm

Connector Handle
1.5 / 2.0 mm

950.072

Mango Conector
1.5 / 2.0 mm



Descrição Description Descripción	Código Code Código	Diâmetro x Comp. Hélice x Comprimento Diameter x Helix Length x Length Diámetro x Largo Hélice x Largo
---	--------------------------	--

Broca Helicoidal

Helicoidal Drill Bit

950.120

Ø1.8 x 38 x 115 mm

Broca Helicoidal

INSTRUMENTAL
INSTRUMENTS
INSTRUMENTALES



Descrição	Código
Description	Code
Descripción	Código

Cabo Reto PD
PD Straight Handle **951.228**
Mango Recto PD



Descrição	Código
Description	Code
Descripción	Código

Compactador de Enxerto
Graft Compactor **951.504**
Compactador de Injerto



Descrição	Código
Description	Code
Descripción	Código

Afastador Tipo Caspar
Caspar Spreader **951.607**
Esparcidor Tipo Caspar



Descrição	Código
Description	Code
Descripción	Código

Pinça do Pino Distrator
Distractor Pin Forceps **951.609**
Pinza do Pino Distractor

INSTRUMENTAL
 INSTRUMENTS
 INSTRUMENTALES



Descrição Description Descripción	Código Code Código	Ø x Comprimento Ø x Length Ø x Largo
---	--------------------------	--

Pino Distrator

Distractor Pin

951.623 Ø2.7x13 mm

Pino Distrator



Descrição Description Descripción	Código Code Código
---	--------------------------

Chave Insertora Cage
 Autobloqueante

Self-locking Cage Inserting
 Wrench

951.710

Llave de Inserción del Cage
 Autobloqueo



Descrição Description Descripción	Código Code Código
---	--------------------------

Base Compactadora de
 Enxerto

Graft Compactor Base

951.712

Base Compactadora Enjerto



Descrição Description Descripción	Código Code Código
---	--------------------------

Impactador Cage
 Autobloqueante

Self-locking Cage Impactor

951.715

Impactador Cage
 Autobloqueo

INSTRUMENTAL
INSTRUMENTS
INSTRUMENTALES



Descrição
Description
Descripción

Código
Code
Código

Trocar Cage Autobloqueante

Self-locking Cage Trocar Tip **951.716**

Trocar Cage Autobloqueante



Descrição
Description
Descripción

Código
Code
Código

Guia Angulado Cage
Autobloqueante

Self-locking Cage Angled
Guide **951.720**

Guía Angulado Cage
Autobloqueo



Descrição
Description
Descripción

Código
Code
Código

Comprimento x Largura x Altura
Length x Width x Height
Largo x Ancho x Altura

Teste Cage Cervical
Autobloqueante

951.739 12 x 14 x 6 mm

951.741 12 x 14 x 7 mm

951.743 12 x 14 x 8 mm

951.759 14 x 16 x 6 mm

Self-locking Cervical Cage Test **951.761** 14 x 16 x 7 mm

951.763 14 x 16 x 8 mm

Testador Cage Cervical **951.769** 15 x 18 x 6 mm

Autobloqueo **951.771** 15 x 18 x 7 mm

951.773 15 x 18 x 8 mm



NEOSPACE - CAGE CILÍNDRICO CERVICAL
NEOSPACE - CERVICAL CYLINDRICAL CAGE
NEOSPACE - CAGE CILÍNDRICO CERVICAL

CONTAINER
CONTAINER
ESTUCHES

951.508

Container Cage Cilíndrico Cervical
Cervical Mesh Cage Container
Estuche Cage Cilíndrico Cervical

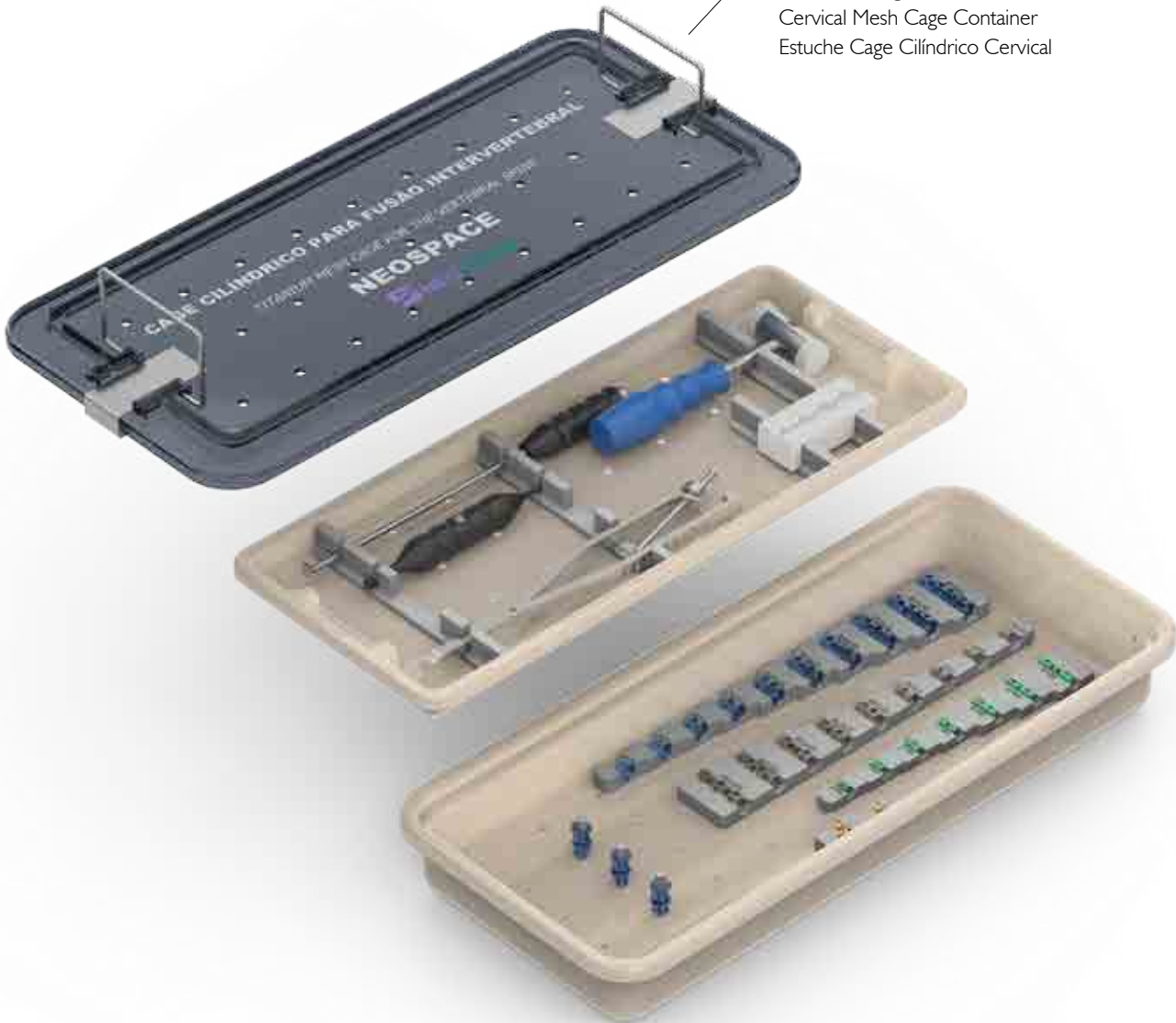

951.599

Conjunto do Container com Implantes e Instrumental
Container with Instruments and Implants Set
Conjunto del Estuche con Implantes e Instrumentales

CAGE CILÍNDRICO CERVICAL
 CERVICAL MESH CAGE
 CAGE CILÍNDRICO CERVICAL

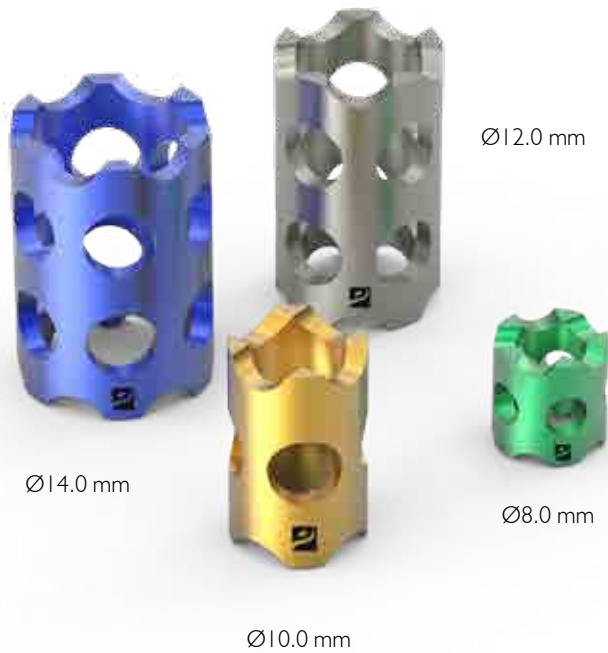

	Ø8 mm	Ø10 mm	Ø12 mm	Ø14 mm
8 mm	941.213	941.221	941.230	941.240
10 mm	941.214	941.222	941.231	941.241
12 mm	941.215	941.223	941.232	941.242
15 mm	941.216	941.224	941.233	941.243
20 mm	941.217	941.225	941.234	941.244
25 mm	941.218	941.226	941.235	941.245
30 mm	941.219	941.227	941.236	941.246
35 mm	•	941.228	941.237	941.247
40 mm	•	•	941.238	941.248
45 mm	•	•	•	941.249

END-CAP - CAGE CILÍNDRICO CERVICAL
 END-CAP - CERVICAL MESH CAGE
 END-CAP - CAGE CILÍNDRICO CERVICAL



	Ø 14 mm
Reto Straight Recto	941.201
Angulado Angled Angulado	941.207

INSTRUMENTAL
INSTRUMENTS
INSTRUMENTALES



Descrição	Código
Description	Code
Descripción	Código

Martelo
Hammer **919.014**
Martillo



Descrição	Código
Description	Code
Descripción	Código

Impactador de Cage Cilíndrico
Mesh Cage Impactor **951.501**
Impactador de Cage Cilíndrico



Descrição	Código
Description	Code
Descripción	Código

Base Compactadora Cervical
Cervical Compactor Base **951.502**
Base Compactadora Cervical



Descrição	Código
Description	Code
Descripción	Código

Aplicador de Cage Cilíndrico
Mesh Cage Pliers **951.503**
Aplicador de Cage Cilíndrico

INSTRUMENTAL
INSTRUMENTS
INSTRUMENTALES



Descrição Description Descripción	Código Code Código
---	--------------------------

Compactador do Enxerto

Graft Compactor

951.504

Compactador del Injerto

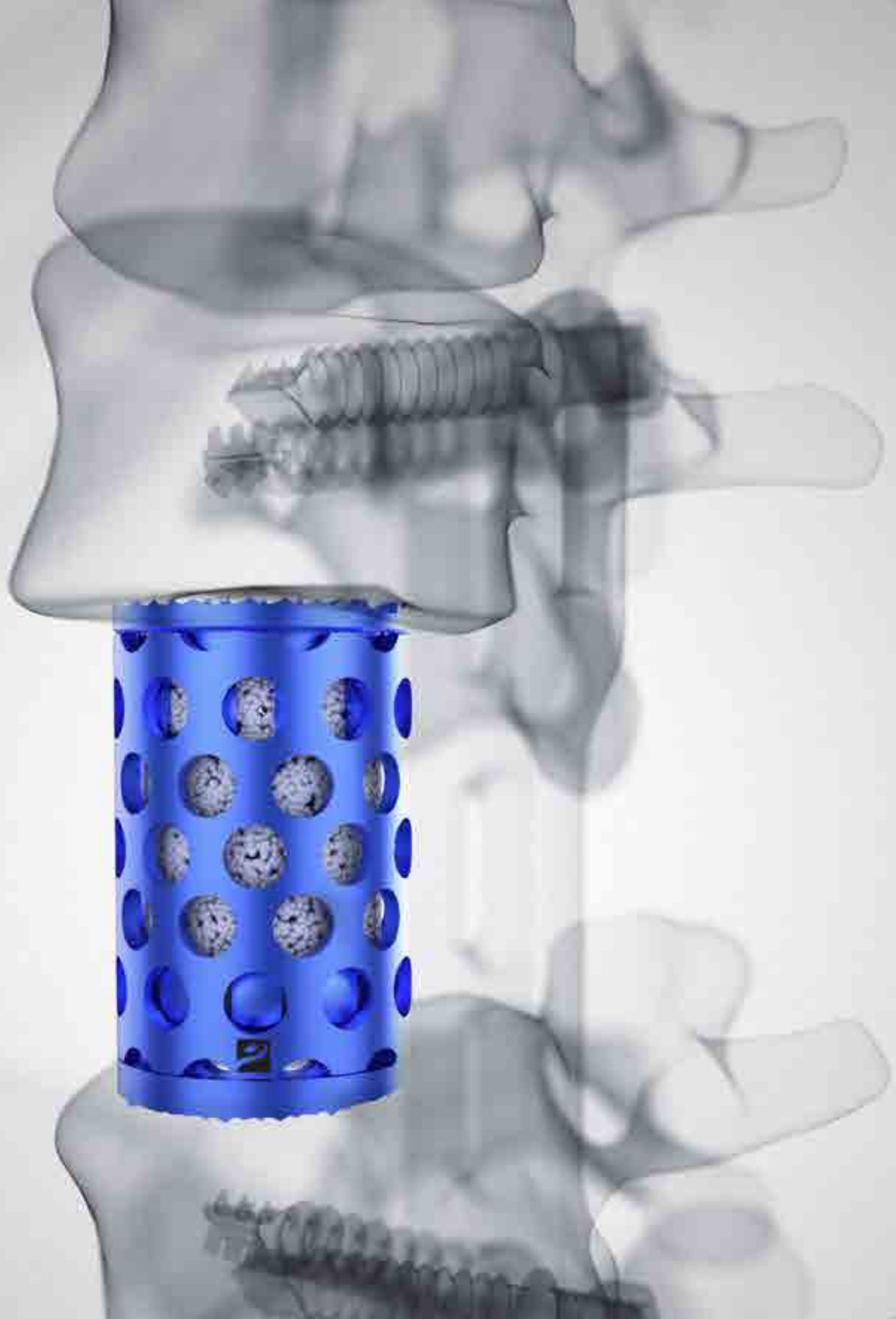

NEOSPACE - CAGE CILÍNDRICO LOMBAR
NEOSPACE - LUMBAR CYLINDRICAL CAGE
NEOSPACE - CAGE CILÍNDRICO LOMBAR

CONTAINER
CONTAINER
ESTUCHES

951.500

Container Cage Cilíndrico Lombar
Lumbar Mesh Cage Container
Estuche Cage Cilíndrico Lumbar

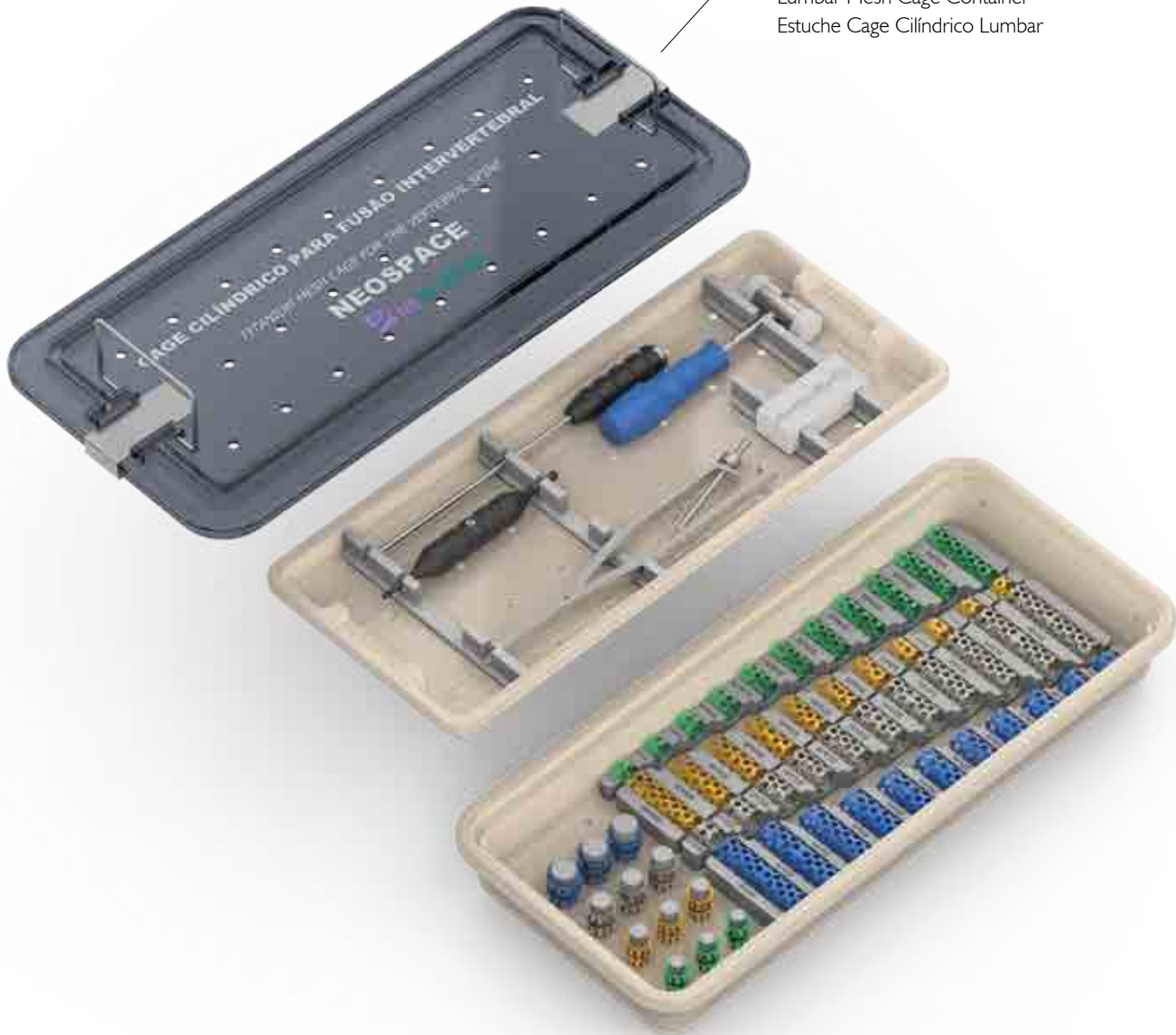

951.598

Conjunto do Container com Implantes e Instrumental
Container with Instruments and Implants Set
Conjunto del Estuche con Implantes e Instrumentales

CAGE CILÍNDRICO
 MESH CAGE
 CAGE CILÍNDRICO

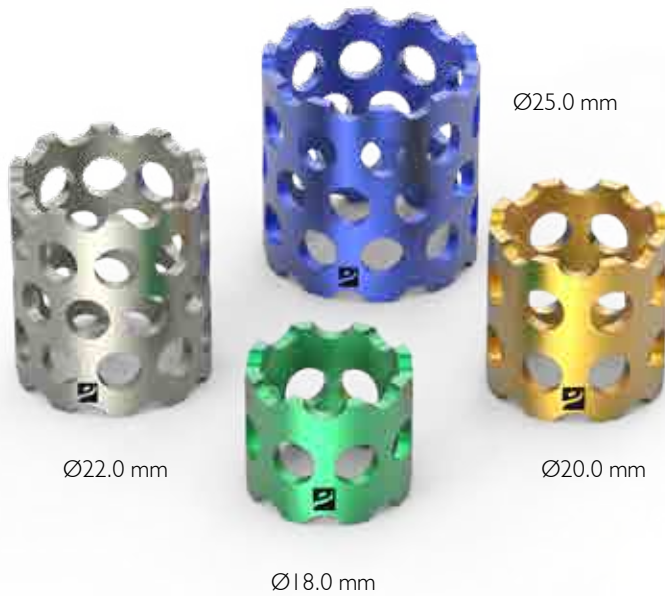

	Ø18 mm	Ø20 mm	Ø22 mm	Ø25 mm
10 mm	941.251	941.263	•	•
12 mm	941.252	941.264	•	•
15 mm	941.253	941.265	941.275	941.286
20 mm	941.254	941.266	941.276	941.287
25 mm	941.255	941.267	941.277	941.288
30 mm	941.256	941.268	941.278	941.289
35 mm	941.257	941.269	941.279	941.290
40 mm	941.258	941.270	941.280	941.291
45 mm	941.259	941.271	941.281	941.292
50 mm	941.260	941.272	941.282	941.293
60 mm	941.261	941.273	941.283	941.294
70 mm	•	•	941.284	941.295
80 mm	•	•	941.285	941.296

END CAP - CAGE CILÍNDRICO
 END CAP - MESH CAGE
 END CAP - CAGE CILÍNDRICO



	Ø18 mm	Ø20 mm	Ø22 mm	Ø25 mm
Reto Straight Recto	941.202	941.203	941.204	941.205
Angulado Angled Angulado	941.208	941.209	941.210	941.211

INSTRUMENTAL
INSTRUMENTS
INSTRUMENTALES



Descrição	Código
Description	Code
Descripción	Código

Martelo
Hammer **919.014**
Martillo



Descrição	Código
Description	Code
Descripción	Código

Impactador de Cage Cilíndrico
Mesh Cage Impactor **951.501**
Impactador de Cage Cilíndrico



Descrição	Código
Description	Code
Descripción	Código

Aplicador de Cage Cilíndrico
Mesh Cage Pliers **951.503**
Alicates de Cage Cilíndrico



Descrição	Código
Description	Code
Descripción	Código

Compactador de Enxerto
Graft Compactor **951.505**
Compactador del Injerto

INSTRUMENTAL
INSTRUMENTS
INSTRUMENTALES



Descrição
Description
Descripción

Código
Code
Código

Base Compactadora Lombar

Lumbar Compactor Base **951.507**

Base Compactadora Lumbar

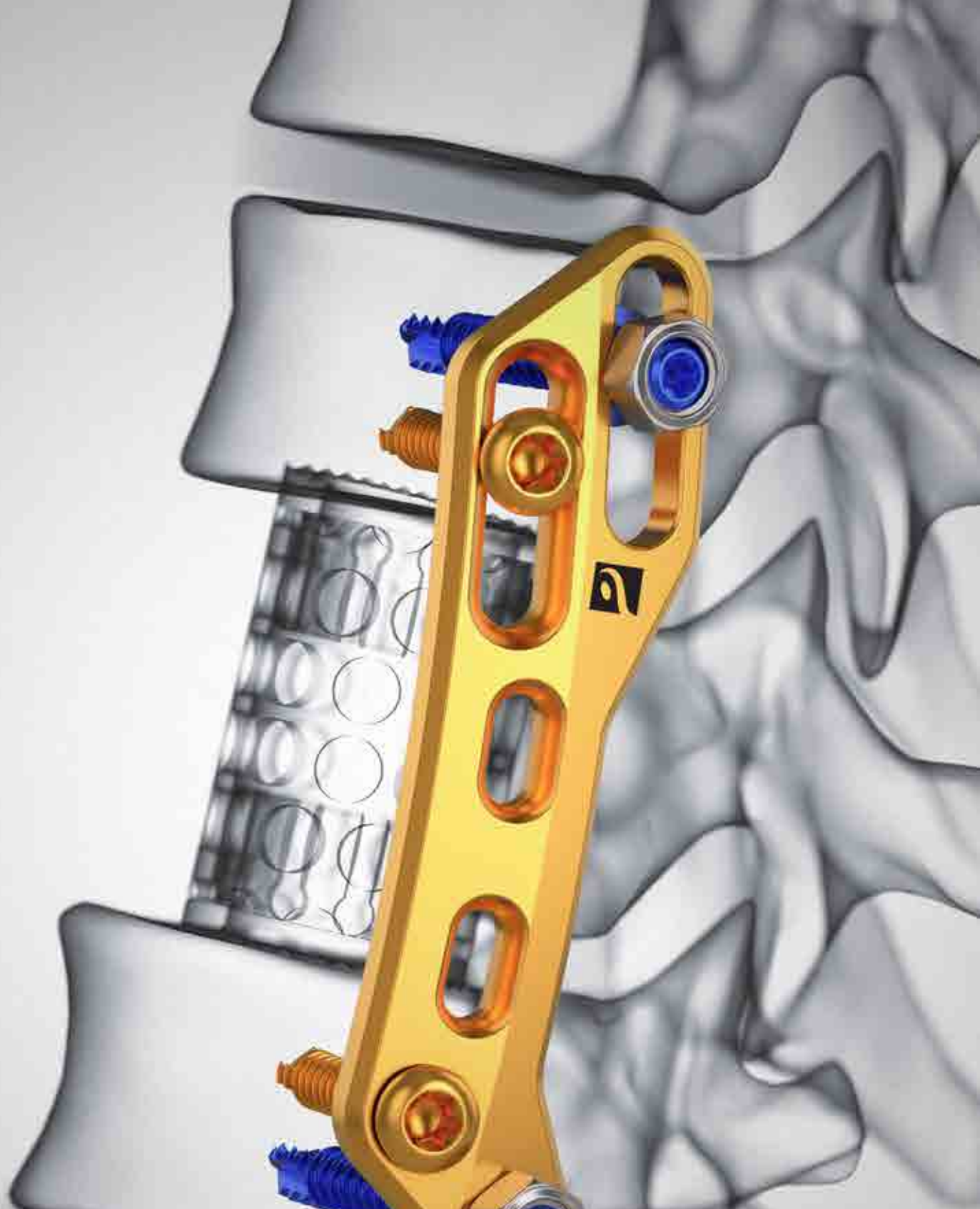

NEOPLATE - PLACA TORACOLOMBAR

NEOPLATE - THORACOLUMBAR PLATE

NEOPLATE - PLACA TORACOLUMBAR

CONTAINER
CONTAINER
ESTUCHES

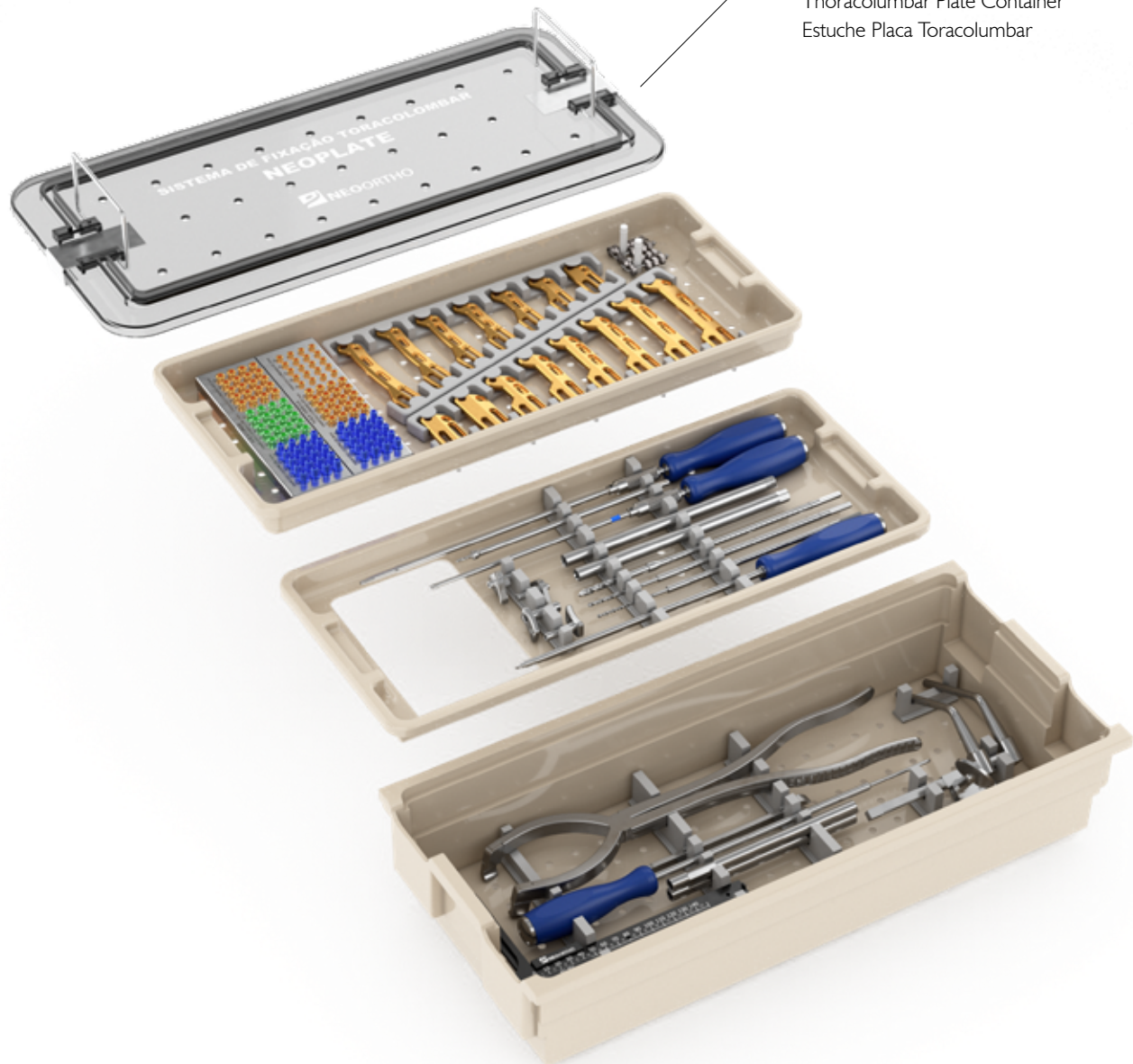

951.872

Container Placa Toracolombar
Thoracolumbar Plate Container
Estuche Placa Toracolombar

951.895

Conjunto do Container com Implantes e Instrumental
Container with Instruments and Implants Set
Conjunto del Estuche con Implantes e Instrumentales

PLACA LOMBAR
LUMBAR PLATE
PLACA LUMBAR



Código Code Código	Comprimento Length Largo
940.900	50 mm
940.901	60 mm
940.903	70 mm
940.905	80 mm
940.907	90 mm
940.908	100 mm
940.910	110 mm
940.912	120 mm

PLACA TORÁCICA
 THORACIC PLATE
 PLACA TORÁCICA



Código Code Código	Comprimento Length Largo
940.960	50 mm
940.961	60 mm
940.962	70 mm
940.963	80 mm
940.964	90 mm
940.965	100 mm
940.966	110 mm

PARAFUSO LOCKING STAR HEAD Ø5.0 mm
 Ø5.0 mm LOCKING SCREW STAR HEAD
 TORNILLO LOCKING STAR HEAD Ø5.0 mm



Código Code Código	Comprimento Length Largo
940.989	25 mm
940.990	30 mm
940.991	35 mm
940.992	40 mm
940.993	45 mm

PARAFUSO CORTICAL STANDARD STAR HEAD Ø3.5 mm
 Ø3.5 mm LOCKING SCREW STAR HEAD
 TORNILLO LOCKING STAR HEAD Ø3.5 mm

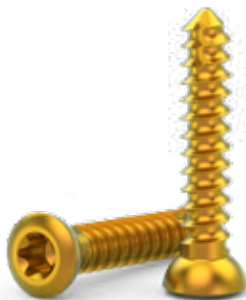

Código Code Código	Comprimento Length Largo
903.037	26 mm
903.039	30 mm
903.041	34 mm
903.043	38 mm
903.045	42 mm

PARAFUSO CORTICAL STANDARD STAR HEAD Ø4.5 mm
 Ø 4.5 mm LOCKING SCREW STAR HEAD
 TORNILLO LOCKING STAR HEAD Ø4.5 mm

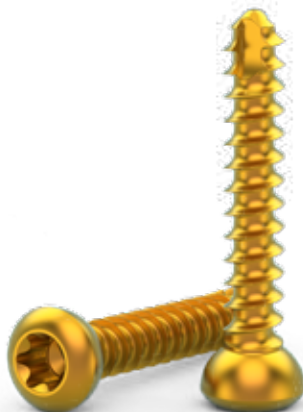

Código Code Código	Comprimento Length Largo
903.106	24 mm
903.109	30 mm
903.112	36 mm
903.114	40 mm
903.119	50 mm

PARAFUSO ESPONJOSO STAR HEAD Ø6.5 mm
 Ø6.5 mm CANCELLOUS SCREW STAR HEAD
 TORNILLO ESPONJOSO STAR HEAD Ø6.5 mm



Código Code Código	Comprimento Length Largo
940.917	30 mm
940.918	35 mm
940.919	40 mm
940.920	45 mm
940.921	50 mm

PARAFUSO LOCKING STAR HEAD Ø7.0 mm
 Ø7.0 mm LOCKING SCREW STAR HEAD
 TORNILLO LOCKING STAR HEAD Ø7.0 mm



Código Code Código	Comprimento Length Largo
940.926	30 mm
940.927	35 mm
940.928	40 mm
940.929	45 mm
940.930	50 mm
940.931	55 mm
940.932	60 mm

PORCA DE FIXAÇÃO
 FIXATION NUT
 TUERCA DE FIJACIÓN



Código Code Código
940.924

INSTRUMENTAL
 INSTRUMENTS
 INSTRUMENTALES



Descrição Description Descripción	Código Code Código
---	--------------------------

Chave T25

T25 Wrench

908.144

Atornillador T25



Descrição Description Descripción	Código Code Código	Comprimento Length Largo
---	--------------------------	--------------------------------

Chave Star Head T15

Star Head T15 Wrench

930.144 Ø 245 mm

Atornillador Star Head T15



Descrição Description Descripción	Código Code Código
---	--------------------------

Cabo Reto PD

PD Straight Handle

951.228

Mango Recto PD



Descrição Description Descripción	Código Code Código
---	--------------------------

Pinça para Placa Cervical

Cervical Plate Pliers

951.602

Pinza para Placa Cervical

INSTRUMENTAL
INSTRUMENTS
INSTRUMENTALES



Descrição	Código
Description	Code
Descripción	Código

Compressor Toracolombar
Thoracolumbar Compressor **951.850**
Compresor Toracolumbar



Descrição	Código
Description	Code
Descripción	Código

Distrator Toracolombar
Thoracolumbar Distractor **951.851**
Distractor Toracolumbar



Descrição	Código
Description	Code
Descripción	Código

Paquímetro Toracolombar
Thoracolumbar Caliper **951.852**
Medidor Toracolumbar



Descrição	Código
Description	Code
Descripción	Código

Guia Inicial Lombar
Lumbar Initial Guide **951.853**
Guía Inicial Lumbar

INSTRUMENTAL
 INSTRUMENTS
 INSTRUMENTALES



Descrição Description Descripción	Código Code Código	Diâmetro Diameter Diámetro
---	--------------------------	----------------------------------

Broca Flexível

Flexible Drill

951.854 Ø 3.0 mm

Broca Flexible



Descrição Description Descripción	Código Code Código
---	--------------------------

Trocar Inicial

Initial Trocar

951.855

Trocar Inicial



Descrição Description Descripción	Código Code Código
---	--------------------------

Guia Posterior Lombar

Lumbar Posterior Guide

951.860

Guía Posterior Lumbar



Descrição Description Descripción	Código Code Código	Diâmetro Diameter Diámetro
---	--------------------------	----------------------------------

Chave Canhão Sextavada

Hexagonal Socket Wrench

951.861 Ø 8.0 mm

Llave de Tubo Hexagonal

INSTRUMENTAL
INSTRUMENTS
INSTRUMENTALES



Descrição
Description
Descripción

Código
Code
Código

Chave de Boca Fixa

Fixed Wrench

951.862

Llave Fija

Descrição
Description
Descripción

Código
Code
Código



Guia Inicial Torácico

Thoracic Initial Guide

951.865

Guía Inicial Torácico

Descrição
Description
Descripción

Código
Code
Código

Diâmetro
Diameter
Diámetro



Broca Flexível

Flexible Drill

951.867 Ø 3.5 mm

Broca Flexible

Descrição
Description
Descripción

Código
Code
Código



Guia Posterior Torácico

Thoracic Posterior Guide

951.870

Guía Posterior Torácico

INSTRUMENTAL
 INSTRUMENTS
 INSTRUMENTALES



Descrição Description Descripción	Código Code Código	Diâmetro Diameter Diámetro
---	--------------------------	----------------------------------

Broca Flexível

Flexible Drill **951.874** Ø 5.5 mm

Broca Flexible



Descrição Description Descripción	Código Code Código
---	--------------------------

Cabo Guia Toracolombar

Thoracolumbar Guide Handle **951.875**

Mango Guía Toracolombar



Descrição Description Descripción	Código Code Código	Diâmetro Diameter Diámetro
---	--------------------------	----------------------------------

Broca

Drill Bit **951.880** Ø 2.5 mm

Broca



NEOPLATE - PLACA CERVICAL ANTERIOR G2

NEOPLATE - G2 ANTERIOR CERVICAL PLATE

NEOPLATE - PLACA CERVICAL ANTERIOR G2

CONTAINER
CONTAINER
ESTUCHES

951.907

Container Placa Cervical G2
Cervical G2 Plate Container
Estuche Placa Cervical G2

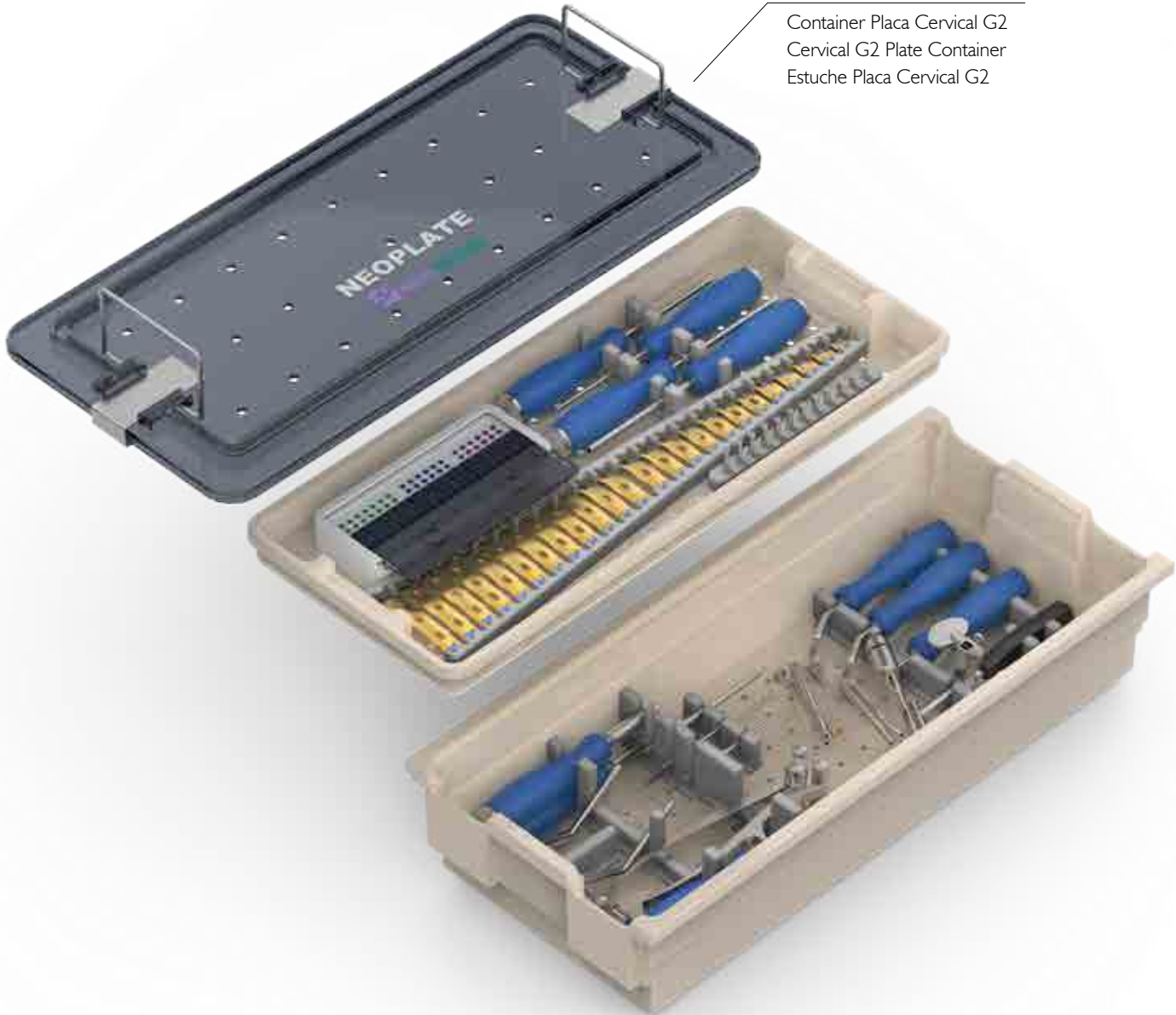

908.990 / 908.991

Conjunto do Container com Implantes e Instrumental
Container with Instruments and Implants Set
Conjunto del Estuche con Implantes e Instrumentales

PLACA CERVICAL ANTERIOR G2
 G2 ANTERIOR CERVICAL PLATE
 PLACA CERVICAL ANTERIOR G2



Oblongo Oblong Oblongo	Comprimento Length Largo	Código Code Código
00	22.5 mm	942.600
00	25.0 mm	942.601
00	27.5 mm	942.602
00	30.0 mm	942.603
00	32.5 mm	942.604
01	35.0 mm	942.605
01	37.5 mm	942.606
01	40.0 mm	942.607
01	42.5 mm	942.608
01	45.0 mm	942.609
01	47.5 mm	942.610
01	50.0 mm	942.611
01	52.5 mm	942.612

Oblongo Oblong Oblongo	Comprimento Length Largo	Código Code Código
01	55.0 mm	942.613
01	57.5 mm	942.614
02	60.0 mm	942.615
02	63.0 mm	942.616
02	66.0 mm	942.617
02	69.0 mm	942.618
02	72.0 mm	942.619
03	75.0 mm	942.620
03	78.0 mm	942.621
03	81.0 mm	942.622
03	84.0 mm	942.623
03	87.0 mm	942.624
03	90.0 mm	942.625

PARAFUSO CERVICAL MONOCORTICAL STAR HEAD Ø3.5 mm
 Ø3.5 mm STAR HEAD MONO-CORTICAL CERVICAL SCREW
 TORNILLO CERVICAL MONO-CORTICAL STAR HEAD Ø3.5 mm



Código Code Código	Comprimento Length Largo
942.650	12 mm
942.651	13 mm
942.652	14 mm
942.653	16 mm
942.654	18 mm
942.655	20 mm
942.656	22 mm

PARAFUSO CERVICAL BICORTICAL STAR HEAD Ø 3.5 mm
 Ø3.5 mm STAR HEAD BICORTICAL CERVICAL SCREW
 TORNILLO CERVICAL BICORTICAL STAR HEAD Ø3.5 mm



Código Code Código	Comprimento Length Largo
942.700	12 mm
942.701	14 mm
942.702	16 mm
942.703	18 mm
942.704	20 mm
942.705	22 mm

PARAFUSO CERVICAL EMERGÊNCIA STAR HEAD Ø4.0 mm
 Ø4.0 mm STAR HEAD EMERGENCY CERVICAL SCREW
 TORNILLO CERVICAL EMERGENCIA STAR HEAD Ø4.0 mm



Código Code Código	Comprimento Length Largo
942.750	12 mm
942.751	14 mm
942.752	16 mm
942.753	18 mm
942.754	20 mm
942.755	22 mm

INSTRUMENTAL
 INSTRUMENTS
 INSTRUMENTALES



Descrição Description Descripción	Código Code Código	Diâmetro Diameter Diámetro
---	--------------------------	----------------------------------

Macho Cortical

Tap for Cortical Screws **908.070** Ø 3.5 mm

Macho Cortical



Descrição Description Descripción	Código Code Código
---	--------------------------

Chave T10

T10 Wrench **908.142**

Atornillador T10



Descrição Description Descripción	Código Code Código
---	--------------------------

Pino Alojamento

Seating Pin **950.063**

Pino Alojamiento



Descrição Description Descripción	Código Code Código	Diâmetro x Hélice x Comprimento Diameter x Helix x Length Diámetro x Hélice x Largo
---	--------------------------	---

Broca Helicoidal

Helical Drill **950.134** Ø 2.0 x 30 x 150 mm

Broca Helicoidal

INSTRUMENTAL
INSTRUMENTS
INSTRUMENTALES



Descrição Description Descripción	Código Code Código	Diâmetro x Hélice x Comprimento Diameter x Helix x Length Diámetro x Hélice x Largo
---	--------------------------	---

Broca Helicoidal

Helical Drill

950.135 Ø 2.5 x 30 x 150 mm

Broca Helicoidal



Descrição Description Descripción	Código Code Código
---	--------------------------

Medidor de Profundidade

Depth Measurer

951.011

Medidor de Profundidad



Descrição Description Descripción	Código Code Código
---	--------------------------

Cabo Reto PD

PD Straight Handle

951.228

Mango Recto PD



Descrição Description Descripción	Código Code Código
---	--------------------------

Afastador Tipo Caspar

Caspar Spreader

951.607

Espaciador Tipo Caspar

INSTRUMENTAL
 INSTRUMENTS
 INSTRUMENTALES



Descrição Description Descripción	Código Code Código	Diâmetro Diameter Diámetro
---	--------------------------	----------------------------------

Pinça do Pino Distrator

Distractor Pin Forceps **951.609** Ø 3.0 mm

Pinza do Pino Distractor



Descrição Description Descripción	Código Code Código
---	--------------------------

Guia do Pino Distrator

Distractor Pin Guide **951.613**

Guía do Pino Distractor



Descrição Description Descripción	Código Code Código
---	--------------------------

Pinça Fixador Temporário

Temporary Fixator Forceps **951.614**

Pinza Fijador Temporario



Descrição Description Descripción	Código Code Código	Diâmetro Diameter Diámetro
---	--------------------------	----------------------------------

Pino Distrator

Distractor Pin **951.623** Ø 2.7 x 13 mm

Pino Distractor

INSTRUMENTAL
INSTRUMENTS
INSTRUMENTALES



Descrição	Código
Description	Code
Descripción	Código

Guia de Broca Duplo
Double Drill Guide **951.900**
Guía Doble de Broca



Descrição	Código
Description	Code
Descripción	Código

Chave F Trava
F Lock Wrench **951.901**
Atornillador F Traba



Descrição	Código
Description	Code
Descripción	Código

Conformador de Placa
Plate Bender **951.904**
Conformador de Placa



Descrição	Código
Description	Code
Descripción	Código

Guia Simples
Simple Guide **951.905**
Guía Simples

INSTRUMENTAL
INSTRUMENTS
INSTRUMENTALES



Descrição Description Descripción	Código Code Código
Pinça Cervical G2	
G2 Cervical Clamp	951.906
Pinza Cervical G2	



Descrição Description Descripción	Código Code Código
Chave de Bloqueio	
Locking Wrench	951.913
Atornillador de Bloqueo	



NEOPLATE - PLACA CONJUGADA CERVICAL

NEOPLATE - CERVICAL CAGE PLATE

NEOPLATE - PLACA CONJUGADA CERVICAL

CONTAINER
CONTAINER
ESTUCHES

951.418

Box Implantes Placa Conjugada Cervical
Cervical Cage Plate Implants Box
Caja Implantes Placa Conjugada Cervical



951.798

Conjunto do Container com Implantes
Container with Implants Set
Conjunto del Estuche con Implantes

PLACA CONJUGADA CERVICAL EM PEEK
 PEEK CERVICAL CAGE PLATE
 PLACA CONJUGADA CERVICAL PEEK



Código Code Código	Comprimento Length Largo
941.800	5.0 mm
941.801	5.5 mm
941.802	6.0 mm
941.803	6.5 mm
941.804	7.0 mm
941.805	7.5 mm

PARAFUSO CERVICAL PEEK
 PEEK CERVICAL SCREW
 TORNILLO CERVICAL PEEK



MONOCORTICAL Ø4 mm
 MONO-CORTICAL Ø4 mm
 MONOCORTICAL Ø4 mm

Código Code Código	Comprimento Length Largo
942.150	12 mm
942.151	14 mm
942.152	16 mm
942.153	18 mm
942.154	20 mm
942.155	22 mm

EMERGÊNCIA Ø4.5 mm
 EMERGENCY Ø4.5 mm
 EMERGENCIA Ø4.5 mm

Código Code Código	Comprimento Length Largo
942.350	12 mm
942.351	14 mm
942.352	16 mm
942.353	18 mm
942.354	20 mm
942.355	22 mm
942.356	24 mm

CONTAINER
CONTAINER
ESTUCHES

951.420

Container Placa Conjugada
Cage Plate Container
Estuche Placa Conjugada Cervical

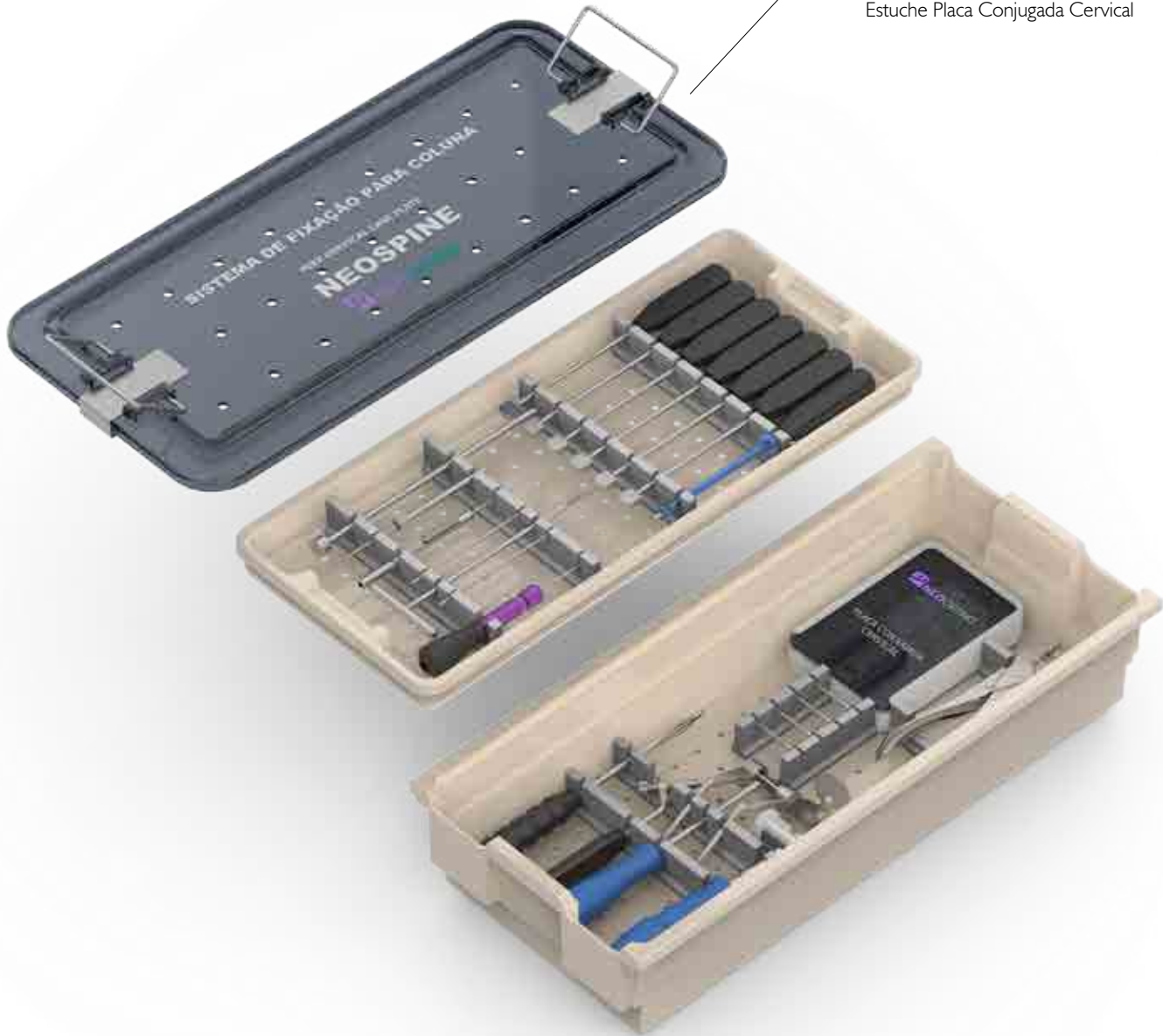

INSTRUMENTAL
 INSTRUMENTS
 INSTRUMENTALES



Descrição Description Descripción	Código Code Código
---	--------------------------

Martelo

Hammer

919.014

Martillo



Descrição Description Descripción	Código Code Código
---	--------------------------

Chave de Mão 1.5 / 2.0 mm

1.5 / 2.0 mm Handle

950.072

Atornillador de Mano 1.5 /
2.0 mm



Descrição Description Descripción	Código Code Código
---	--------------------------

Medidor de Profundidade

Depth Measurer

950.089

Medidor de Profundidad



Descrição Description Descripción	Código Code Código
---	--------------------------

Compressor Cage Cervical

Cervical Cage Compressor

951.400

Compresor Cage Cervical

INSTRUMENTAL
INSTRUMENTS
INSTRUMENTALES



Descrição Description Descripción	Código Code Código
---	--------------------------

Impactador Cage Cervical

Cervical Cage Impactor **951.401**

Impactador Cage Cervical



Descrição Description Descripción	Código Code Código	Comprimento Length Largo
---	--------------------------	--------------------------------

Teste Cage Cervical

951.404

5.0 mm

951.405

5.5 mm

Cervical Cage Tester

951.406

6.0 mm

951.407

6.5 mm

Teste Cage Cervical

951.408

7.0 mm

951.412

7.5 mm



Descrição Description Descripción	Código Code Código
---	--------------------------

Chave Placa Conjugada em Peek

Peek Cage Plate Wrench **951.419**

Atornillador Placa Conjugada en Peek



Descrição Description Descripción	Código Code Código
---	--------------------------

Macho Cervical

Cervical Tap **951.603**

Macho Cervical

INSTRUMENTAL
 INSTRUMENTS
 INSTRUMENTALES



Descrição Description Descripción	Código Code Código	Diâmetro Diameter Diámetro
---	--------------------------	----------------------------------

Broca Helicoidal

Helical Drill

951.606 Ø2.2 x 86 x 119 mm

Broca Helicoidal



Descrição Description Descripción	Código Code Código
---	--------------------------

Afastador Tipo Caspar

Caspar Spreader

951.607

Espaciador Tipo Caspar



Descrição Description Descripción	Código Code Código
---	--------------------------

Pinça do Pino Distrator

Distractor Pin Forceps

951.609

Pinza do Pino Distractor



Descrição Description Descripción	Código Code Código
---	--------------------------

Guia de Broca Simples

Simple Drill Guide

951.617

Guía de Broca Simples

INSTRUMENTAL
INSTRUMENTS
INSTRUMENTALES



Descrição	Código	Diâmetro
Description	Code	Diameter
Descripción	Código	Diámetro

Chave Hexagonal

Hexagonal Wrench **951.620** Ø 3.0 mm

Atornillador Hexagonal



Descrição	Código
Description	Code
Descripción	Código

Perfurador Pino Distrator

Distractor Pin Awl **951.622**

Perforador Pino Distrator



Descrição	Código	Diâmetro
Description	Code	Diameter
Descripción	Código	Diámetro

Pino Distrator

Distractor Pin **951.623** Ø2.7 x 13 mm

Pino Distrator

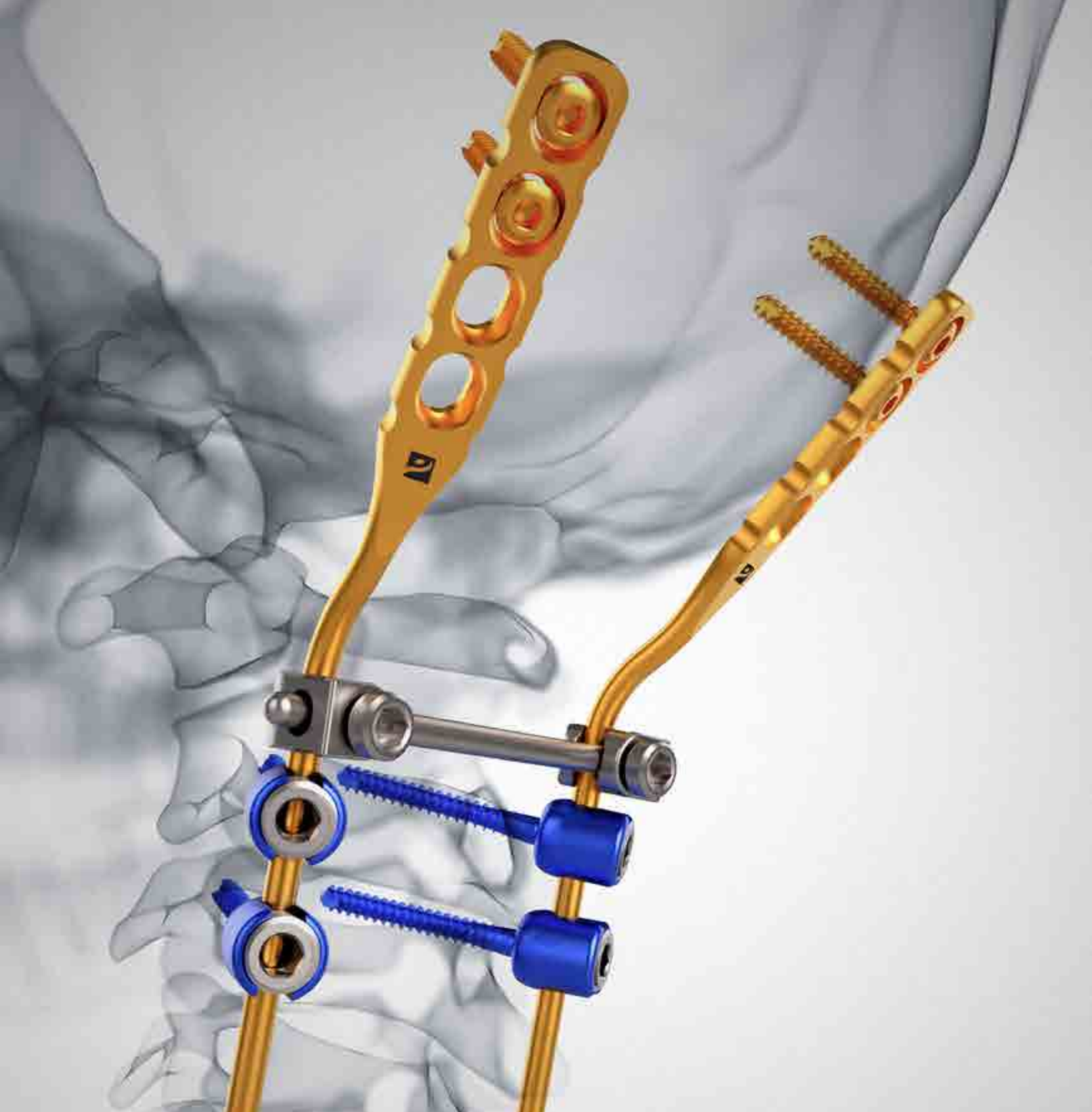

NEOCCIPITO - SISTEMA DE FIXAÇÃO OCCIPITOCERVICAL

NEOCCIPITO - OCCIPITOCERVICAL FIXATION SYSTEM

NEOCCIPITO - SISTEMA DE FIJACIÓN OCCIPITOCERVICAL

CONTAINER
CONTAINER
ESTUCHES

951.805

Container Neoccipito
Neoccipito Container
Estuche Neoccipito



951.899

Conjunto do Container com Implantes e Instrumental
Container with Instruments and Implants Set
Conjunto Estuches con Implantes e Instrumentales

PLACA CERVICAL POSTERIOR
 POSTERIOR CERVICAL PLATE
 POSTERIOR PLACA CERVICAL



Código Code Código	Furos Holes Agujeros
940.500	02
940.501	03
940.502	04
940.503	05
940.504	06

HASTE OCCIPITOCERVICAL Ø3.5 mm
 Ø3.5 mm OCCIPITOCERVICAL ROD
 BARRA OCCIPITOCERVICAL Ø3.5 mm



Código Code Código	Comprimento Length Largo
940.633	80 mm
940.634	120 mm
940.635	240 mm

BARRA CERVICAL Ø3.5 mm
 Ø3.5 mm CERVICAL ROD
 BARRA CERVICAL Ø3.5 mm



Código Code Código	Comprimento Length Largo
940.630	80 mm
940.631	120 mm
940.632	240 mm

BARRA TRANSVERSAL Ø3.5 mm
 Ø3.5 mm TRANSVERSAL ROD
 BARRA TRANSVERSAL Ø3.5 mm



Código Code Código	Comprimento Length Largo
940.648	20 mm
940.649	30 mm
940.650	40 mm
940.651	50 mm
940.652	60 mm
940.653	70 mm

PARAFUSO CORTICAL CERVICAL Ø3.5 mm
 Ø3.5 mm CERVICAL CORTICAL SCREW
 TORNILLOS CORTICAL CERVICAL Ø3.5 mm



Código Code Código	Comprimento Length Largo
940.518	08 mm
940.519	10 mm
940.520	12 mm
940.521	14 mm
940.522	16 mm
940.523	18 mm
940.524	20 mm
940.525	22 mm
940.526	24 mm
940.527	26 mm

PARAFUSO POLIAXIAL CERVICAL Ø3.5 mm
 Ø3.5 mm CERVICAL POLYAXIAL SCREW
 TORNILLO POLIAXIAL CERVICAL Ø3.5 mm



Código Code Código	Comprimento Length Largo
940.621	08 mm
940.622	10 mm
940.600	12 mm
940.601	14 mm
940.602	16 mm
940.603	18 mm
940.604	20 mm
940.605	22 mm
940.606	24 mm
940.607	26 mm
940.608	28 mm

Código Code Código	Comprimento Length Largo
940.609	30 mm
940.610	32 mm
940.611	34 mm
940.612	36 mm
940.613	38 mm
940.614	40 mm
940.615	42 mm
940.616	44 mm
940.617	46 mm
940.618	48 mm
940.619	50 mm

PARAFUSO BLOQUEADOR SEXTAVADO Ø8.0 mm
 Ø8.0 mm HEXAGONAL SCREWS BLOCKER
 TORNILLO HEXAGONAL BLOQUEADOR Ø8.0 mm



Código Code Código
940.639

CONECTOR
CONNECTOR
CONECTOR

940.656 Barra Ø5.2 / 3.5 mm
Rod Ø5.2 / 3.5 mm
Barra Ø5.2 / 3.5 mm

940.658 Barra Ø6.0 / 3.5 mm
Rod Ø6.0 / 3.5 mm
Barra Ø6.0 / 3.5 mm

940.645 Paralelo Ø3.5 x 3.5 mm
Parallel Ø3.5 x 3.5 mm
Paralelo Ø3.5 x 3.5 mm



940.643 Desvío Ø3.5 x 5.2 mm
Bypass Ø3.5 x 5.2 mm
Desvío Ø3.5 x 5.2 mm

940.644 Desvío Ø3.5 x 3.5 mm
Bypass Ø3.5 x 3.5 mm
Desvío Ø3.5 x 3.5 mm

940.647 Transversal Ø3.5 mm
Transversal Ø3.5 mm
Transversal Ø3.5 mm

INSTRUMENTAL
 INSTRUMENTS
 INSTRUMENTALES



Descrição Description Descripción	Código Code Código	Diâmetro Diameter Diámetro
---	--------------------------	----------------------------------

Macho Cortical

Tap for Cortex Screws **908.070** Ø3.5 mm

Macho Cortical



Descrição Description Descripción	Código Code Código
---	--------------------------

Medidor de Profundidade
2.5-4.5 mm

Depth Measurer 2.5-4.5 mm **908.080**

Medidor de Profundidad
2.5-4.5 mm



Descrição Description Descripción	Código Code Código
---	--------------------------

Torquímetro 4 Nm

Torquemeter 4 Nm **908.133**

Torquimetro 4 Nm



Descrição Description Descripción	Código Code Código
---	--------------------------

Chave Catraca AO

AO Ratchet Wrench **908.248**

Atornillador Torniquete AO

INSTRUMENTAL
INSTRUMENTS
INSTRUMENTALES



Descrição	Código
Description	Code
Descripción	Código

Pinça para Barra Transversal

Cross-link Forceps **951.054**

Pinza para Barra Transversal



Descrição	Código
Description	Code
Descripción	Código

Probe Pediátrico

Probe PD **951.203**

Sonda Pediátrico



Descrição	Código
Description	Code
Descripción	Código

Marcador Pedicular Direito

Right Pedicle Marker **951.220**

Marcador Pedicular Derecho



Descrição	Código
Description	Code
Descripción	Código

Marcador Pedicular Esquerdo

Left Pedicle Marker **951.221**

Marcador Pedicular Izquierdo

INSTRUMENTAL
 INSTRUMENTS
 INSTRUMENTALES



Descrição Description Descripción	Código Code Código
---	--------------------------

Perfurador Pediátrico
 Ø3.5 mm Cabo Pera

Tear Drop Awl
 Ø3.5 mm PD

951.225

Perfurador Pediátrico
 Ø3.5 mm Mango Pera



Descrição Description Descripción	Código Code Código
---	--------------------------

Conformador Neooccipito

Rod Bender

951.700

Conformador Neooccipito



Descrição Description Descripción	Código Code Código
---	--------------------------

Chave Hexagonal
 2.5 mm

Hexagonal Wrench
 2.5 mm

951.701

Atornillador Hexagonal
 2.5 mm



Descrição Description Descripción	Código Code Código
---	--------------------------

Perfurador Inicial Neooccipito

Neooccipito Initial Awl

951.800

Perforador Inicial Neooccipito

INSTRUMENTAL
INSTRUMENTS
INSTRUMENTALES



Descrição	Código
Description	Code
Descripción	Código

Pinça de Barra Neocipito
Neocipito Rod Clamp **951.801**
Pinza de Barra Neocipito



Descrição	Código
Description	Code
Descripción	Código

Distrator Neocipito
Distractor **951.802**
Distractor Neocipito



Descrição	Código
Description	Code
Descripción	Código

Compressor Neocipito
Neocipito Compressor **951.803**
Compresor Neocipito



Descrição	Código
Description	Code
Descripción	Código

Chave Antitorque Cervical
Cervical Anti-torque Wrench **951.804**
Atornillador Antitorque Cervical

INSTRUMENTAL
 INSTRUMENTS
 INSTRUMENTALES



Descrição Description Descripción	Código Code Código
---	--------------------------

Conexão Polifix Neooccipito

Neooccipito Polyfix Connection **951.806**

Conexión Polifix Neooccipito



Descrição Description Descripción	Código Code Código	Diâmetro Diameter Diámetro
---	--------------------------	----------------------------------

Template

Template **951.808** Ø3.5 mm

Template



Descrição Description Descripción	Código Code Código
---	--------------------------

Conexão Torquímetro 4 Nm

TorqueMeter Connection 4 Nm **951.809**

Conexión Torquímetro 4 Nm



Descrição Description Descripción	Código Code Código
---	--------------------------

Conexão Bloqueador Neooccipito

Neooccipito Locking Screw Connector **951.810**

Conexión Bloqueador Neooccipito

INSTRUMENTAL
INSTRUMENTS
INSTRUMENTALES



Descrição	Código
Description	Code
Descripción	Código

Conformador in Situ
Occipitocervical

In Situ Occipitocervical
Bender **951.811**

Conformador In Situ
Occipitocervical



Descrição	Código
Description	Code
Descripción	Código

Guia de Broca Simples

Simple Drill Guide **951.813**

Guía de Broca Simples



Descrição	Código	Diâmetro
Description	Code	Diameter
Descripción	Código	Diámetro

Conexão Hexagonal

Hexagonal Connection **951.815** Ø3.5 mm

Conexión Hexagonal



Descrição	Código	Diâmetro
Description	Code	Diameter
Descripción	Código	Diámetro

Broca Helicoidal AO

Helicoidal Drill **951.816** Ø2.5 x 94 x 127 mm

Broca Helicoidal AO

INSTRUMENTAL
INSTRUMENTS
INSTRUMENTALES



Descrição
Description
Descripción

Código
Code
Código

Punho Reto AO

AO Straight Handle

Mango Recto AO

951.817

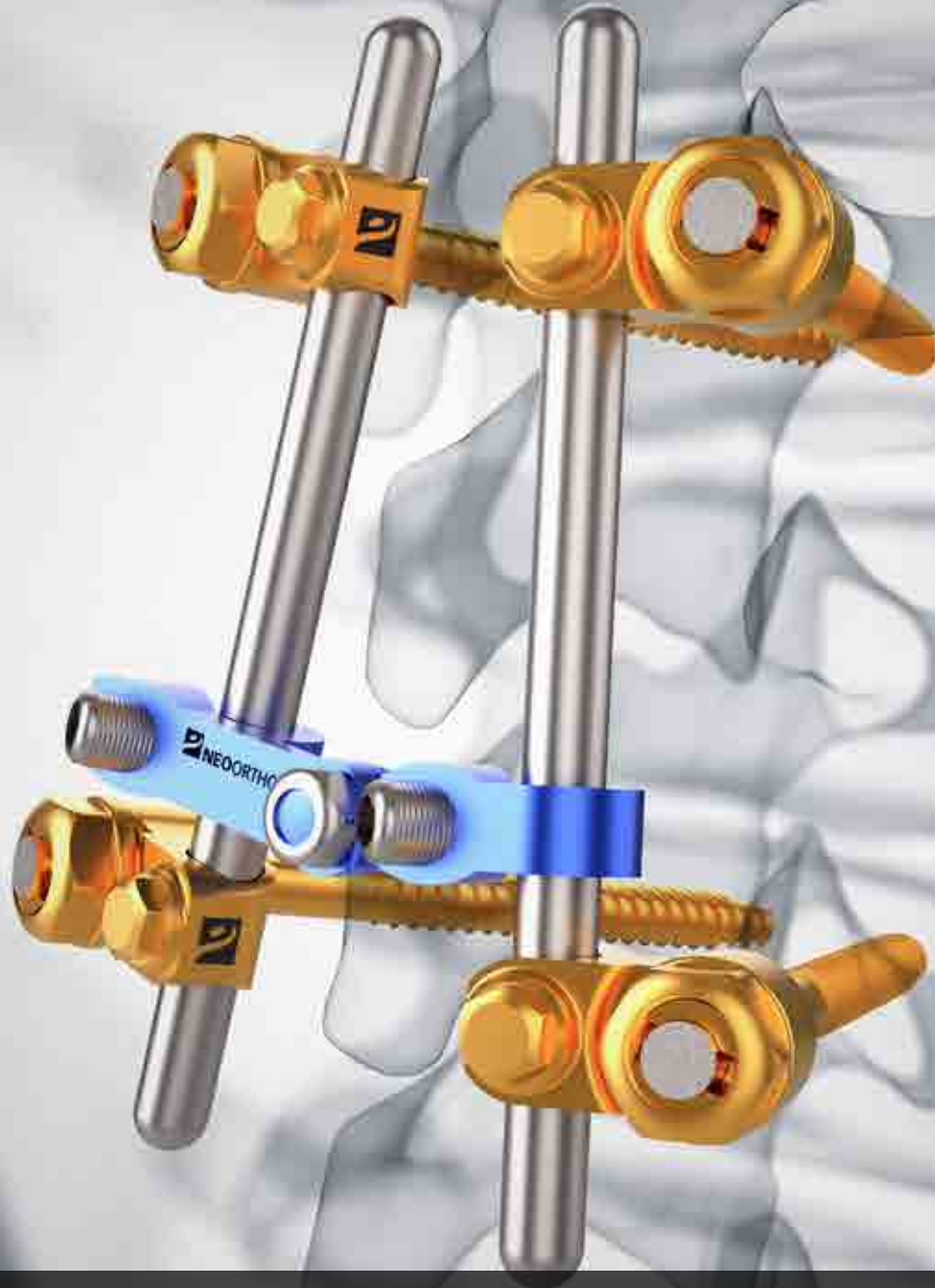

FIXADOR INTERNO
INTERNAL FIXATOR
FIJADOR INTERNO

CONTAINER
CONTAINER
ESTUCHES

952.018

Container Implantes Fixador Interno
Internal Fixator Implants Container
Estuche Implantes Fijador Interno

952.019

Box Implantes Fixador Interno
Internal Fixator Implants Box
Caja Implantes Fijador Interno



952.099

Conjunto do Container com Implantes e Instrumental
Container with Instruments and Implants Set
Conjunto del Estuche con Implantes y Instrumentales

FIXADOR INTERNO
INTERNAL FIXATOR
FIJADOR INTERNO



	Ø 5.0 mm	Ø 6.0 mm	Ø 7.0 mm
35 mm	940.700	940.710	940.720
40 mm	940.701	940.711	940.721
45 mm	940.702	940.712	940.722
50 mm	940.703	940.713	940.723
55 mm	940.704	940.714	940.724

Comprimento Total 180 mm
Total Length 180 mm
Largo Total 180 mm

FIXADOR INTERNO ESPONDILOLISTESE
SPONDYLOLISTHESIS INTERNAL FIXATOR
FIJADOR INTERNO ESPONDILOLISTESIS



	Ø 5.0 mm	Ø 6.0 mm	Ø 7.0 mm
35 mm	940.730	940.740	940.750
40 mm	940.731	940.741	940.751
45 mm	940.732	940.742	940.752
50 mm	940.733	940.743	940.753
55 mm	940.734	940.744	940.754

Comprimento Total 180 mm
Total Length 180 mm
Largo Total 180 mm

BARRA TRANSVERSAL FLEXÍVEL
 FLEXIBLE TRANSVERSAL ROD
 BARRA TRANSVERSAL FLEXIBLE



Código Code Código	Comprimento Length Largo
940.328	42 - 52 mm
940.329	52 - 62 mm
940.330	62 - 72 mm
940.331	72 - 82 mm
940.332	36 - 41 mm
940.333	30-35 mm

BARRA TRANSVERSAL FIXA
 FIXED TRANSVERSAL ROD
 BARRA TRANSVERSAL FIJA



Código Code Código	Comprimento Length Largo
940.185	25 mm
940.186	30 mm
940.187	35 mm
940.188	40 mm
940.189	45 mm

CONECTOR FIXADOR INTERNO Ø6 mm
Ø6 mm INTERNAL FIXATOR CONNECTOR
CONECTOR FIJADOR INTERNO Ø6 mm



Código
Code
Código

940.761

BARRA Ø6 mm
Ø6 mm ROD
BARRA Ø6 mm



Código Code Código	Comprimento Length Largo
940.762	40 mm
940.763	50 mm
940.764	60 mm
940.765	70 mm
940.766	80 mm
940.767	90 mm

Código Code Código	Comprimento Length Largo
940.768	100 mm
940.769	110 mm
940.770	120 mm
940.771	130 mm
940.772	150 mm
940.773	160 mm

CONTAINER
CONTAINER
ESTUCHES

952.012

Container Instrumental Fixador Interno
Internal Fixator Instrumental Container
Estuche Instrumentales Fijador Interno



952.100

Conjunto do Container com Instrumental
Container with Instruments Set
Conjunto del Estuche con Instrumentales

INSTRUMENTAL
INSTRUMENTS
INSTRUMENTALES



Descrição Description Descripción	Código Code Código
---	--------------------------

Distractor

Distractor

951.003

Distractor



Descrição Description Descripción	Código Code Código
---	--------------------------

Compressor

Compressor

951.004

Compresor



Descrição Description Descripción	Código Code Código
---	--------------------------

Cabo Reto

Straight Handle

951.015

Mango Recto



Descrição Description Descripción	Código Code Código
---	--------------------------

Pinça para Barra Transversal

Cross-link Forceps

951.054

Pinza para Barra Transversal

INSTRUMENTAL
INSTRUMENTS
INSTRUMENTALES



Descrição
Description
Descripción

Código
Code
Código

Rotacionador com Ajuste de Pressão

Rotator Pressure Adjustment

Rotador con Ajuste de Presión

951.061



Descrição
Description
Descripción

Código
Code
Código

Conexão Parafuso Bloqueador

Locking Screw Connector

Conexión Tornillo Bloqueador

951.108



Descrição
Description
Descripción

Código
Code
Código

Diâmetro
Diameter
Diámetro

Conexão Hexagonal

Hexagonal Connector

Conexión Hexagonal

951.110 Ø 3.5 mm



Descrição
Description
Descripción

Código
Code
Código

Conexão Pressionador de Barra

Rod Press Connector

Conexión Prensador de Barra

951.111

INSTRUMENTAL
INSTRUMENTS
INSTRUMENTALES



Descrição Description Descripción	Código Code Código
---	--------------------------

Conexão Hexagonal Interna
7 mm

Hexagonal Internal Connector
7 mm **951.122**

Conexión Hexagonal Interna
7 mm



Descrição Description Descripción	Código Code Código
---	--------------------------

Perfurador com Cabo Pera

Tear Drop Awl **951.129**

Perforador con Mango Pera



Descrição Description Descripción	Código Code Código
---	--------------------------

Perfurador Inicial com Cabo Pera

Initial Awl **951.132**

Perforador Inicial con Mango Pera



Descrição Description Descripción	Código Code Código
---	--------------------------

Probe Pediátrico

Probe PD **951.203**

Sonda Pediátrico

INSTRUMENTAL
INSTRUMENTS
INSTRUMENTALES



Descrição	Código
Description	Code
Descripción	Código

Perfurador com Cabo Pera
Pediátrico

Pediatric Tear Drop Awl **951.226**

Perforador con Mango Pera
Pediátrico



Descrição	Código
Description	Code
Descripción	Código

Chave Canulada

Cannulated Wrench **952.002**

Atornillador Canulado



Descrição	Código
Description	Code
Descripción	Código

Trava Chave Canulada

Cannulated Wrench Lock **952.003**

Bloqueo Atornillador
Canulado



Descrição	Código
Description	Code
Descripción	Código

Cisalhador

Shear **952.004**

Cizalla

INSTRUMENTAL
INSTRUMENTS
INSTRUMENTALES



Descrição Description Descripción	Código Code Código
Chave T	
T Wrench	952.005
Atornillador T	



Descrição Description Descripción	Código Code Código
Chave Hexagonal Interno 6 mm	
Hexagonal Internal Wrench 6 mm	952.008
Atornillador Hexagonal Interno 6 mm	



Descrição Description Descripción	Código Code Código
Tubo e Manipulo Corretor de Listese	
Tube and Handle for Listhesis Correction	952.013
Tubo e Manipulo Corrector de Listesis	



Descrição Description Descripción	Código Code Código
Gancho	
Hook	952.014
Gancho	

INSTRUMENTAL
INSTRUMENTS
INSTRUMENTALES

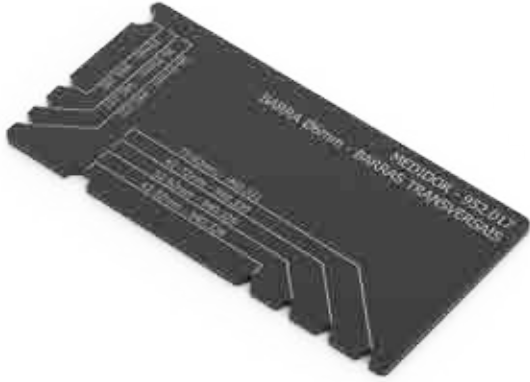

Descrição
Description
Descripción

Código
Code
Código

Medidor para Barra
Transversal

Transversal Rod Measurer

952.017

Medidor para Barra
Transversal



PARAFUSO CANULADO CERVICAL (ODONTÓIDE)
CERVICAL CANNULATED SCREW (ODONTOID)
TORNILLO CANULADO CERVICAL (ODONTOIDES)

CONTAINER
CONTAINER
ESTUCHES



951.699

Conjunto do Container com Implantes e Instrumental
Container with Instruments and Implants Set
Conjunto del Estuche con Implantes y Instrumentales

PARAFUSO ODONTÓIDE
 ODONTOID SCREW
 TORNILLO ODONTOIDES



	Ø 3.5 mm	Ø 4.0 mm
30 mm	942.509	942.501
32 mm	942.510	942.502
34 mm	942.511	942.503
36 mm	942.512	942.504
38 mm	942.513	942.505
40 mm	942.514	942.506
42 mm	942.515	942.507
44 mm	942.516	942.508

INSTRUMENTAL
INSTRUMENTS
INSTRUMENTALES



Descrição	Código
Description	Code
Descripción	Código

Chave Escariadora

Countersink Wrench **951.651**

Avellanador

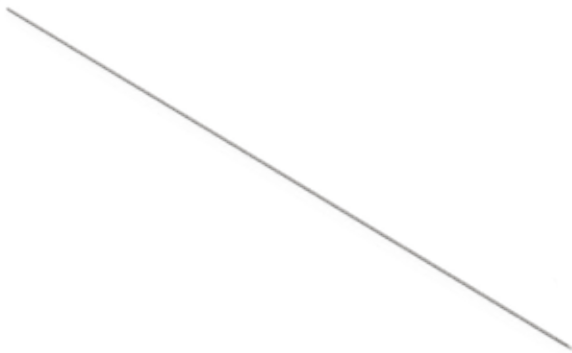

Descrição	Código	Diâmetro
Description	Code	Diameter
Descripción	Código	Diámetro

Fio Guia

Guide Wire **951.652** Ø1,4 x 320 mm

Hilo Guía



Descrição	Código
Description	Code
Descripción	Código

Guia de Fio

Wire Guide **951.653**

Guía de Hilo



Descrição	Código
Description	Code
Descripción	Código

Medidor de Profundidade

Depth Measurer **951.654**

Medidor de Profundidad

INSTRUMENTAL
INSTRUMENTS
INSTRUMENTALES



Descrição
Description
Descripción

Código
Code
Código

Chave Hexagonal Canulada
2.5 mm

2.5 mm Cannulated
Hexagonal Wrench

951.655

Atornillador Hexagonal
Canulado 2.5 mm





NEOORTHO Produtos Ortopédicos S/A

Rua Ângelo Domingos Durigan, 607

Cascatina – 82025-100

Curitiba – PR – Brasil

+55 41 3535 1000

Indústria Brasileira