

# Velofix™ PEEK Cervical Cage

**S**urgical Technique



**U&I** CORPORATION

1 **Rounded edges** for easier insertion

2 **Contact surfaces with prominent serrations**  
enhance implant stability and prevent implant migration at the endplates

3 **Large central window**  
allows for improved loading capacity for bone graft material, optimizing bony integration

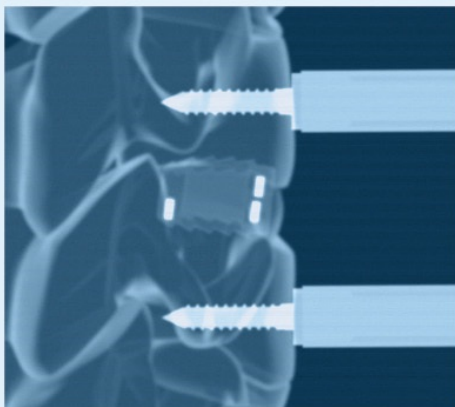
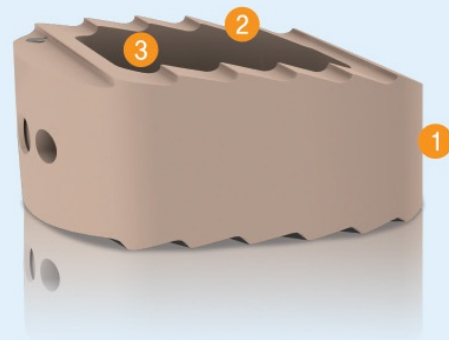

**Three radiographic tantalum rod markers**  
allow for improved fluoroscopic placement  
and post-operative examination with no  
artifact during x-ray evaluation

#### **Threading inserter**

for securing implant while loading and  
easy mechanism for release

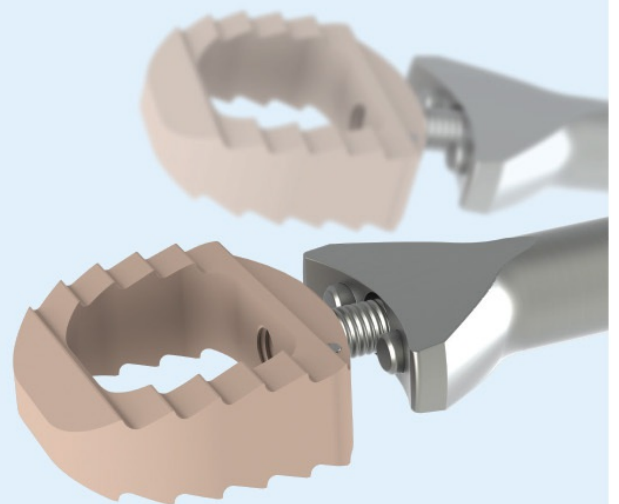

# PATIENT POSITIONING AND SURGICAL EXPOSURE

The patient is placed in supine position. Fluoroscopy can be made available for interoperative check. An anterior approach to the cervical spine is used through a right or left cervicotomy, according to the surgeon's preference. The anterior aspect of the vertebral bodies cephalad and caudal to the segment involved are exposed.

## DISTRACTION OF THE DISC SPACE

Instrument	
SC7170	TEMPORARY FIXATION PIN DRIVER
SC7230	RETRACTOR
SC7260	RETRACTOR FIXATION PIN

Insert the RETRACTOR FIXATION PIN in the vertebrae above and below the disc to be removed with the TEMPORARY FIXATION PIN DRIVER (Fig. 1). Insert the sleeves of the RETRACTOR on the RETRACTOR FIXATION PIN till fully seated ①. Unscrew the RETRACTOR wheel to open the intervertebral space to the desired height ② (Fig. 2). Care should be taken in order to avoid over distraction.

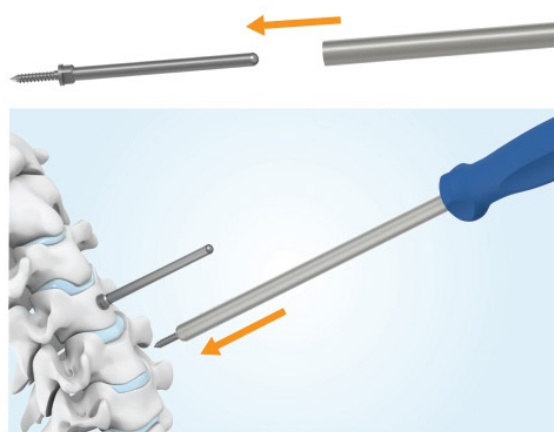

Fig. 1

## DISCECTOMY

A conventional scalpel discectomy is performed by incising the annulus. Bilaterally, soft fragments from the intradiscal space or extruded fragments are removed with the disc rongeur in a conventional fashion.

A complete discectomy may not be possible at this stage until the disc space distraction is accomplished.

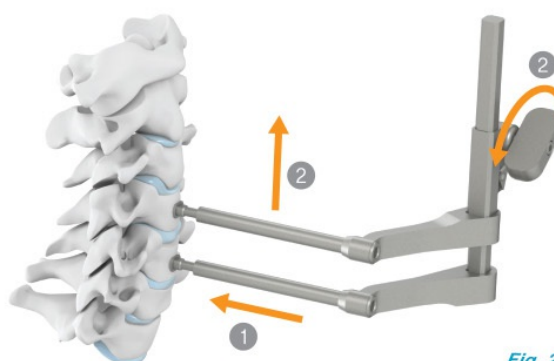

Fig. 2

# ENDPLATE PREPARATION

Under distraction, complete a neural decompression by trimming large posterior osteophytes (if present).

To remove the cartilaginous endplates, thereby creating a flat surface of bleeding bone, choose one of the following options:

## Option 1

Instrument	
PE1001	PEEK C CAGE INSERTER
PE141205R~10R	PEEK CAGE RASP, W14D12H5~10
PE141405R~10R	PEEK CAGE RASP, W14D14H5~10
PE161405R~10R	PEEK CAGE RASP, W16D14H5~10

Connect the size-specific RASP to the PEEK C CAGE INSERTER (Fig. 3).

Introduce the RASP into the intervertebral space to scrape the cartilaginous endplates (Fig. 4).

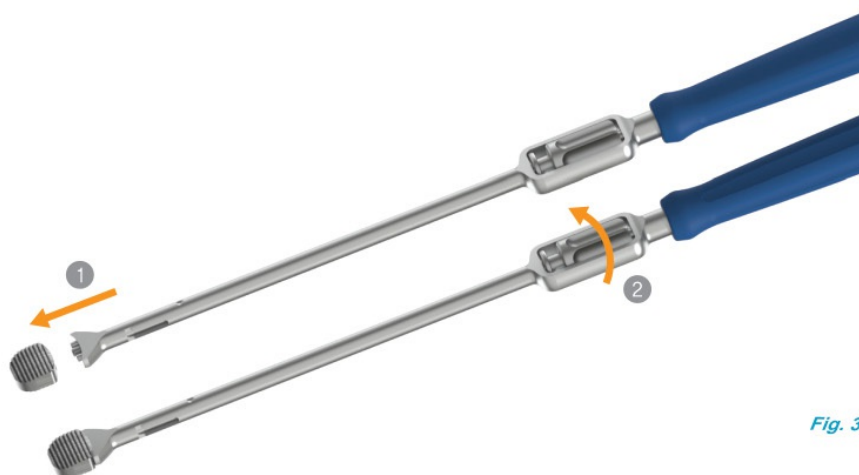

Fig. 3

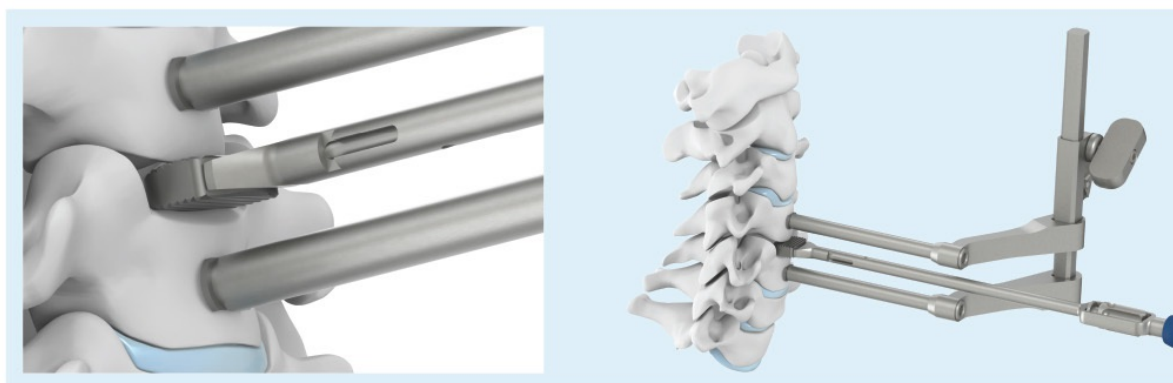

Fig. 4

## Option 2

Instrument	
PE2010	SINGLE SIDE RASP SMALL
PE2020	SINGLE SIDE RASP MEDIUM
PE2030	SINGLE SIDE RASP LARGE

• Size in small (W14D12), medium (W14D14), large (W16D14)

The SINGLE SIDE RASP can be alternatively used (Fig.5).

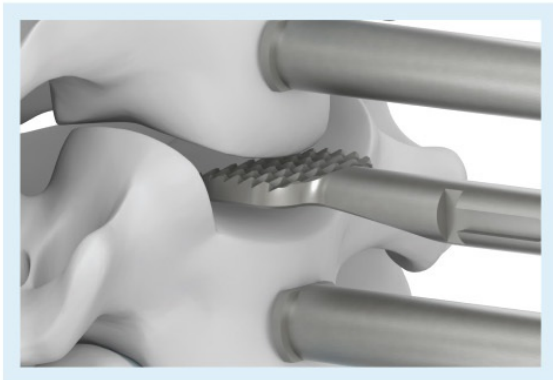

Fig. 5

## Option 3

Instrument	
PE1040	CERVICAL CAGE CURETTE

The CURETTE is another option for scraping (Fig.6).

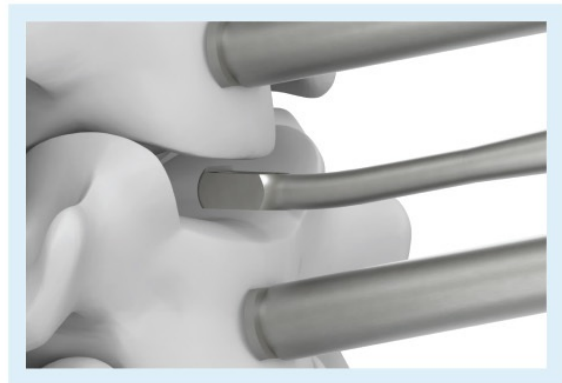

Fig. 6

# SELECTION OF THE CAGE

Instrument	
PE1001	PEEK C CAGE INSERTER
PE141200T *	PEEK CAGE TRIAL

\* Size in small (W14D12), medium (W14D14), large (W16D14)

Connect the TRIAL to the PEEK C CAGE INSERTER. The TRIAL is then introduced into the intervertebral space under fluoroscopic control (Fig. 7)



Fig. 7

Make sure the cranial faces upwards when inserting the trial. It is generally advisable to select the minimal TRIAL height for which proper stability is obtained. To test this stability, distraction is momentarily relaxed.

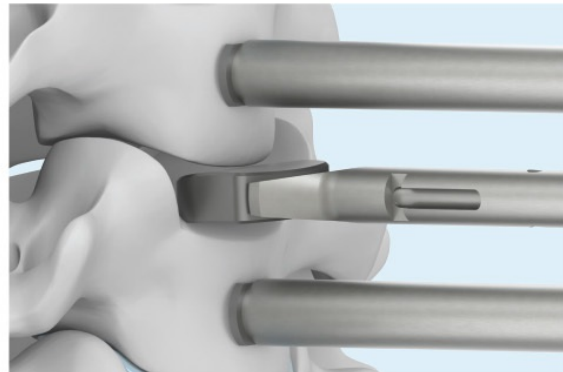

# FILLING IN THE CAGE

Instrument	
PE1001	PEEK C CAGE INSERTER
PE1020	PACKING PLATFORM
CC0932	PEEK-C BONE PACKING BAR

Connect the selected PEEK Cervical Cage to the PEEK C CAGE INSERTER (Fig. 8) and place the cage on the PACKING PLATFORM.

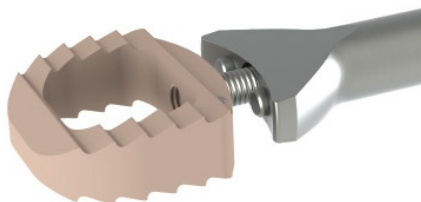

Fig. 8

Autologous bone or biologics are options for filling the cage with the PEEK-C BONE PACKING BAR (Fig. 9).

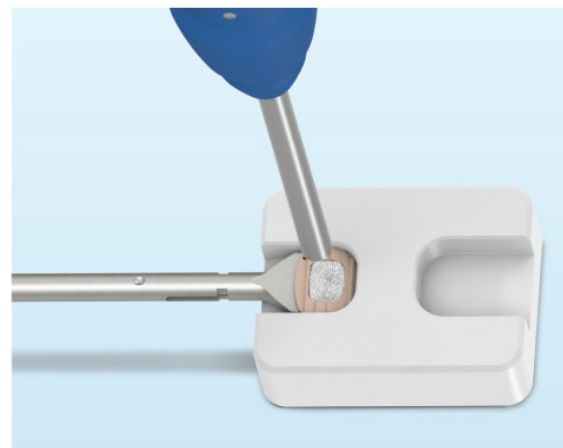

Fig. 9

# INSERTION OF THE IMPLANT

Instrument	
PE1030	DEPTH LIMITER 0 mm
PE1032	DEPTH LIMITER 2 mm
PE1034	DEPTH LIMITER 4 mm

Insert the cage into the disc space (Fig. 10).

The cage is impacted while distraction of the interbody space is maintained in such a manner that minimal resistance is felt during insertion.

Optionally, the DEPTH LIMITER can be used to control the insertion depth of the cage (Fig. 11).

Use image intensifier to confirm the position of the implant (Fig. 12).

When the cage positioning is satisfactory, apply compression to the treated segment: first release the retractor ramp brake ①, then turn the wheel ② (Fig. 13).

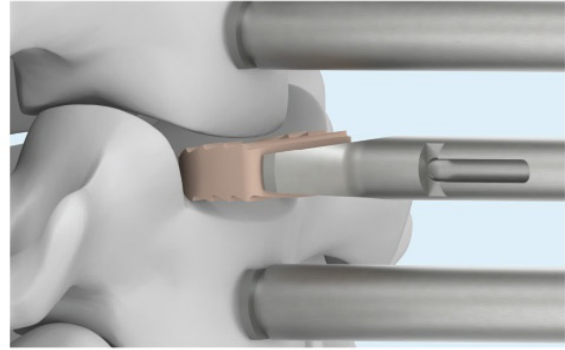

Fig. 10

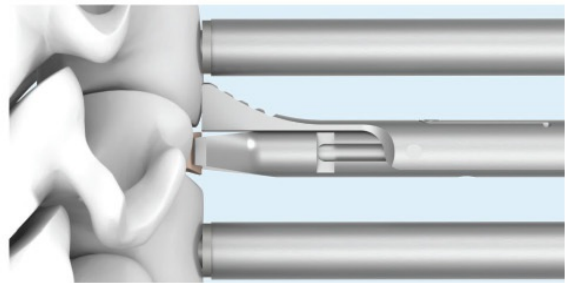

Fig. 11

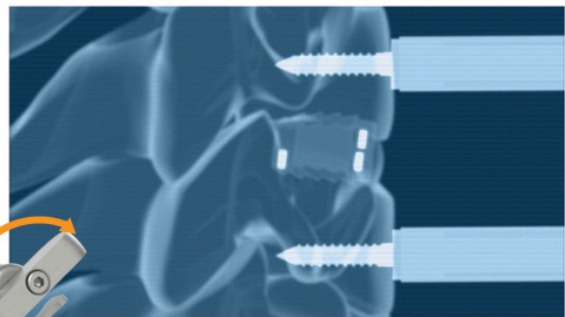

Fig. 12

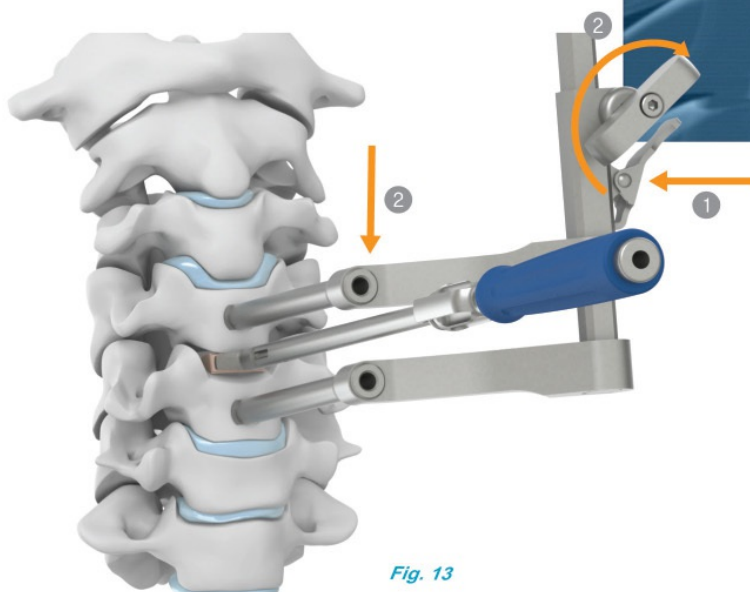

Fig. 13

# SUPPLEMENTAL FIXATION

For multi-segmental instrumentation, Velofix™ PEEK Cervical Cage is intended to be used with U&I supplemental fixation, e.g. ASPIRON™ or MAXIMA™ ACP.

# IMPLANT REMOVAL/REVISION

Should removal/revision of the device be determined necessary by the surgeon, an osteotome can be used at the interface between the bone and both superior and inferior faces of the implant. This effectively cuts the fused column of bone at the level of the boundaries of the implant. Once the fused column is completely cut, forceps can be used to remove the implant from the space. This may be done under slight distraction.

For a revision, follow the standard surgical technique.

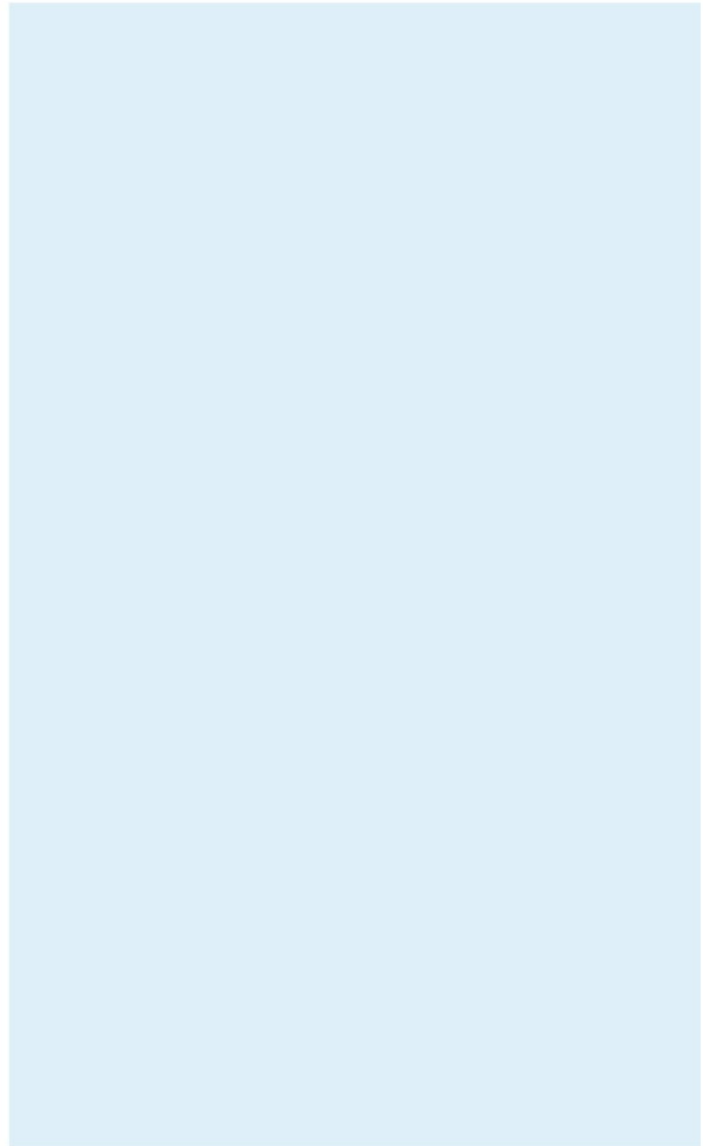



# DISASSEMBLE CAGE INSERTER

Instrument	
PE1010	PEEK-C CAGE INSERTER

Disassemble the CAGE INSERTER prior to cleaning according to the disassembling instruction shown here.

To assemble the CAGE INSERTER, follow the instruction in reverse order.

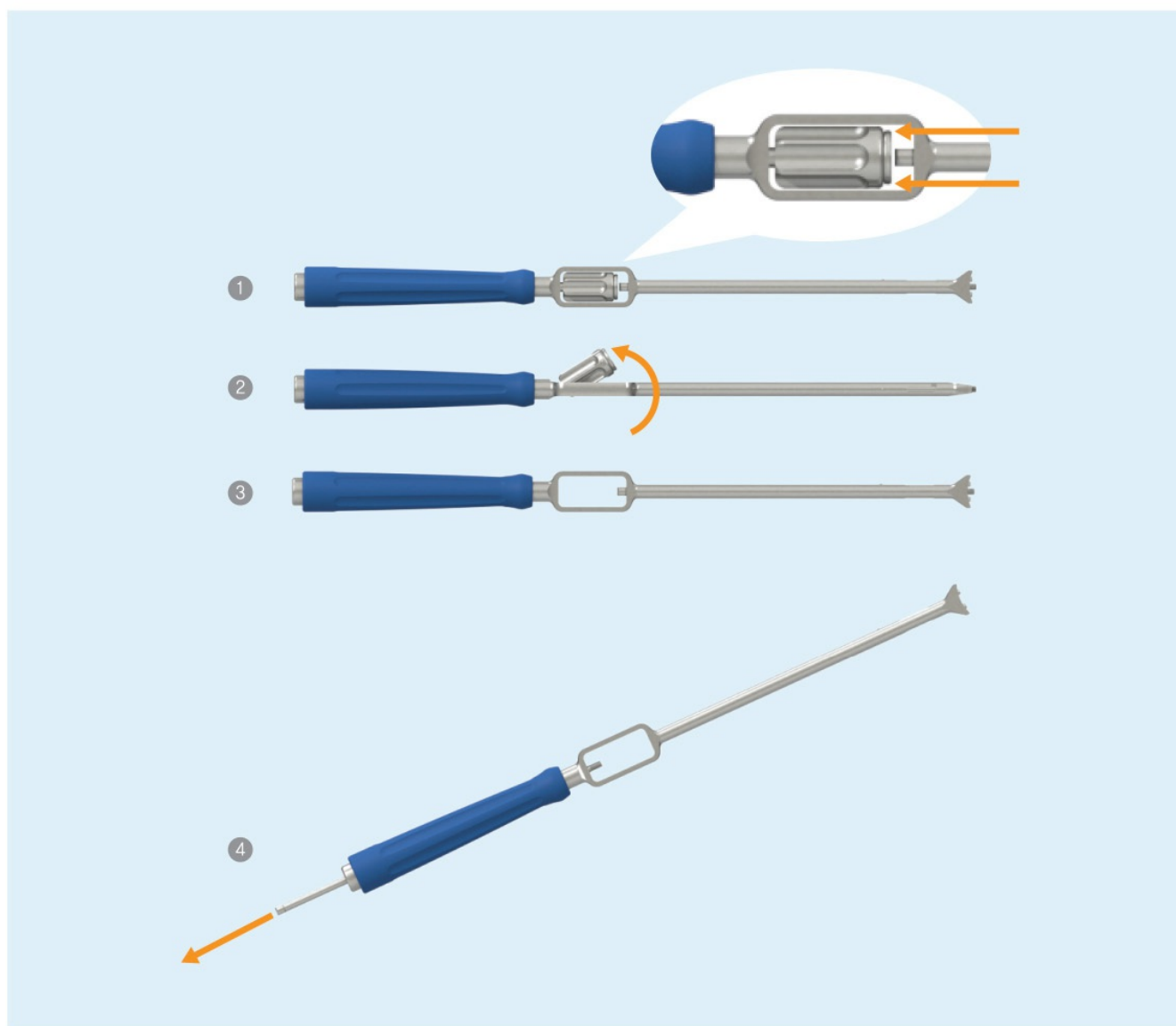

# Ordering Information

Implant (Single-Use Only)

Cat. No.	W (mm)	D (mm)	H (mm)	Size
PE141205	14	12	5	Small
PE141206	14	12	6	
PE141207	14	12	7	
PE141208	14	12	8	
PE141209	14	12	9	
PE141210	14	12	10	
PE141405	14	14	5	Standard
PE141406	14	14	6	
PE141407	14	14	7	
PE141408	14	14	8	
PE141409	14	14	9	
PE141410	14	14	10	
PE161405	16	14	5	Large
PE161406	16	14	6	
PE161407	16	14	7	
PE161408	16	14	8	
PE161409	16	14	9	
PE161410	16	14	10	

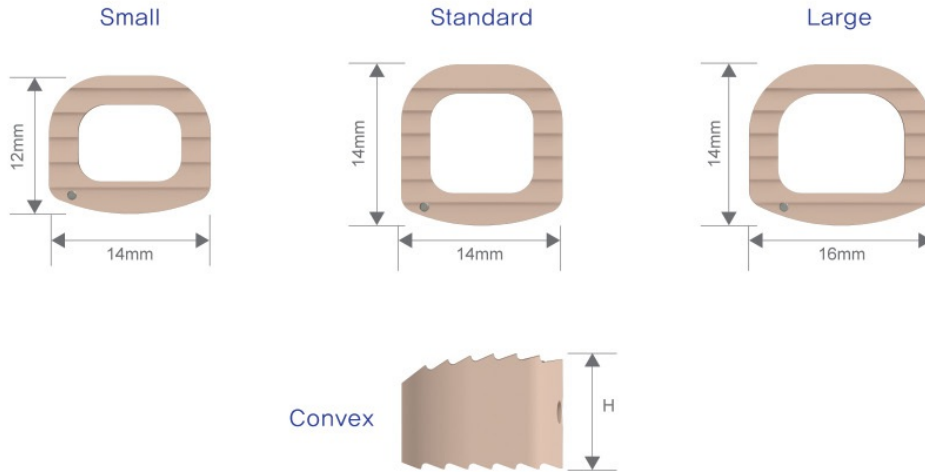

## Instruments

**TRIAL**

Cat. No.	W (mm)	D (mm)	H (mm)
PE141205T	14	12	5
PE141206T	14	12	6
PE141207T	14	12	7
PE141208T	14	12	8
PE141209T	14	12	9
PE141210T	14	12	10
PE141405T	14	14	5
PE141406T	14	14	6
PE141407T	14	14	7
PE141408T	14	14	8
PE141409T	14	14	9
PE141410T	14	14	10
PE161405T	16	14	5
PE161406T	16	14	6
PE161407T	16	14	7
PE161408T	16	14	8
PE161409T	16	14	9
PE161410T	16	14	10

**RASP**

Cat. No.	W (mm)	D (mm)	H (mm)
PE141205R	14	12	5
PE141206R	14	12	6
PE141207R	14	12	7
PE141208R	14	12	8
PE141209R	14	12	9
PE141210R	14	12	10
PE141405R	14	14	5
PE141406R	14	14	6
PE141407R	14	14	7
PE141408R	14	14	8
PE141409R	14	14	9
PE141410R	14	14	10
PE161405R	16	14	5
PE161406R	16	14	6
PE161407R	16	14	7
PE161408R	16	14	8
PE161409R	16	14	9
PE161410R	16	14	10

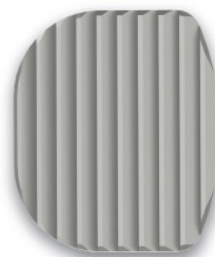

**PE1001**

PEEK C CAGE INSERTER



**PE1020**

PACKING PLATFORM

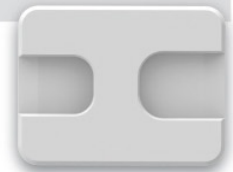

**PE1030**

DEPTH LIMITER 0mm



**PE1032**

DEPTH LIMITER 2mm



**PE1034**

DEPTH LIMITER 4mm



**PE1040**

CERVICAL CAGE CURETTE



**PE2010**

SINGLE SIDE RASP SMALL



**PE2020**

SINGLE SIDE RASP MEDIUM



**PE2030**

SINGLE SIDE RASP LARGE



**SC7170**

TEMPORARY FIXATION PIN DRIVER



**SC7230**

RETRACTOR



**SC7260**

RETRACTOR FIXATION PIN



**CC0932**

PEEK-C BONE PACKING BAR









**Headquarter**

20, Sandan-ro 76beon-gil(Rd),  
Uijeongbu-si, Gyeonggi-do, Korea 480-859  
Tel. + 82 (31) 852 0102  
Fax. +82 (31) 852 9025

**USA Office**

555 W Lambert Road Suite F Brea, CA 92821  
Tel. + 1 (714) 280 4955  
Fax. +1 (714) 209 7571