

**SURGICAL  
TECHNIQUE**

PRECISION SPINE  
**DAKOTA ACDF™**  
STANDALONE CERVICAL SYSTEM

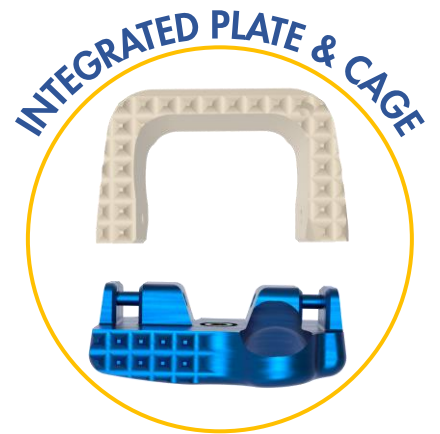

PRECISION SPINE®  
*Discover the Difference*



# TABLE OF CONTENTS



<b>OVERVIEW</b>	<b>3</b>
<b>SYSTEM FEATURES</b>	<b>4</b>
<b>SET CONFIGURATION</b>	<b>6</b>
<b>SURGICAL TECHNIQUE</b>	<b>11</b>
Patient Positioning	11
Exposure & Distraction	11
Endplate Preparation	11
Interbody Sizing	11
Interbody Insertion	12
Screw Hole Preparation	14
Screw Insertion	15
Locking Mechanism	16
Implant Removal	16
<b>INDICATIONS, CONTRAINDICATIONS, WARNINGS, and PRECAUTIONS</b>	<b>17</b>

# SYSTEM OVERVIEW

The Dakota ACDF™ System simplifies standalone cervical procedures to enhance the fusion process. An integrated plate and cage interbody with instrumentation facilitate intraoperative challenges and decrease OR time while providing reproducible results.

- **Dual thread screws** maximize cortical and cancellous bone interface
- **One-step, integrated locking mechanism** provides tactile and visual confirmations for increased confidence
- **Intuitive, low profile instrumentation** accommodates diverse patient anatomies

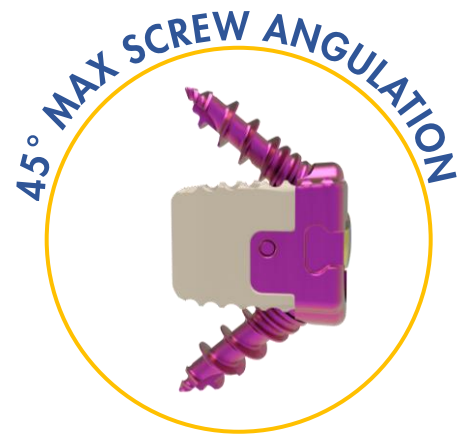

## INDICATIONS

The **Dakota ACDF** System is a standalone titanium and PEEK cervical interbody device intended for use in skeletally mature patients with degenerative disc disease (DDD) of the cervical spine (C2-T1) at one- or two-disc levels. DDD is defined as discogenic pain with degeneration of the disc confirmed by history and radiographic studies. The **Dakota ACDF** implants are used with two titanium alloy screws and filled with autogenous bone graft material to facilitate fusion in the cervical spine. The device is placed via an anterior approach at the C2 to T1 disc levels. Patients should have at least six weeks of non-operative treatment prior to treatment with an intervertebral fusion device.

# SYSTEM FEATURES

## INTEGRATED PLATE & CAGE INTERBODY

**Footprints** 14mm x 12mm & 16mm x 14mm  
**Lordosis** 7°  
**Heights** 6 - 12mm, 1mm increments  
**Locking Plate** T8 Interface

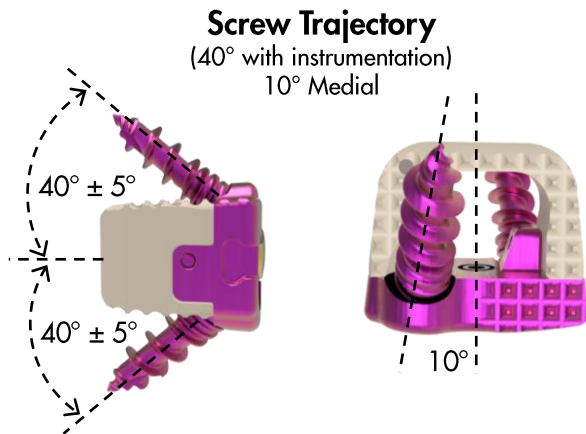
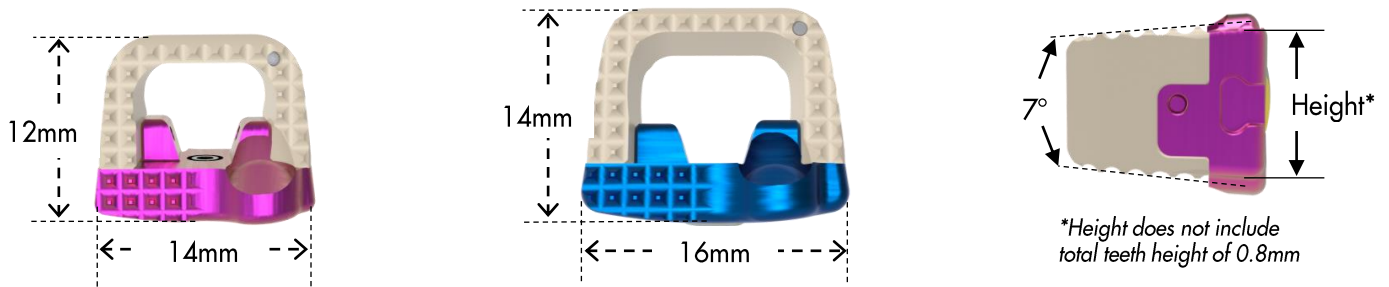

### Plate & Cage Interbody

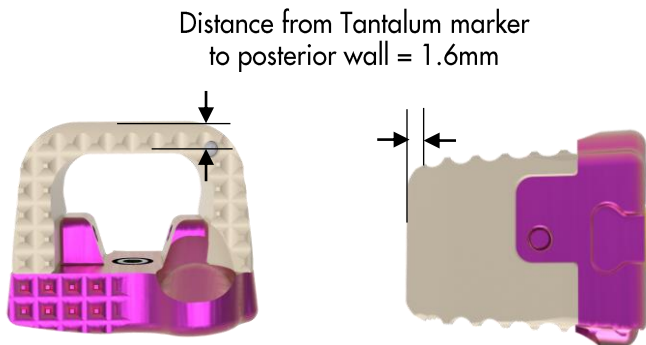

Interbody Height	Locking Plate Color	
6mm	Natural	●
7mm	Dark Blue	●
8mm	Gold	●
9mm	Green	●
10mm	Dark Purple	●
11mm	Seafoam Green	●
12mm	Magenta	●

# SYSTEM FEATURES

## SCREWS

- **Cortical Cancellous Threads** to maximize bone-screw interface
- **T8 Interface**

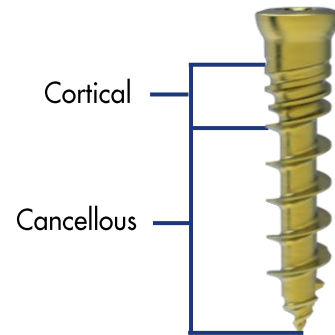

### Screw Diameters

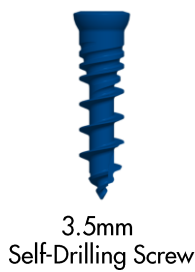

### Screw Lengths

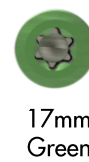
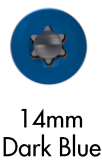
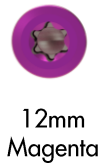

### Screw Engagement at 40°

Screw Length (mm)	14mm x 12mm		16mm x 14mm	
	Depth (D)	Height (H)	Depth (D)	Height (H)
12	0-Flush	6.6	-2.0	6.6
14	1.0	7.7	0-Flush	7.7
15	2.0	8.9	1.0	8.9
17	3.5	10.0	2.0	10.0

**Note:** Awls and Drill Guide allow for a screw angulation of 40°. The total screw engagement with the vertebrae is dependent on the interbody footprint and bone screw length. Utilize the reference chart to determine screw length engagement when the screw is placed at 40°.

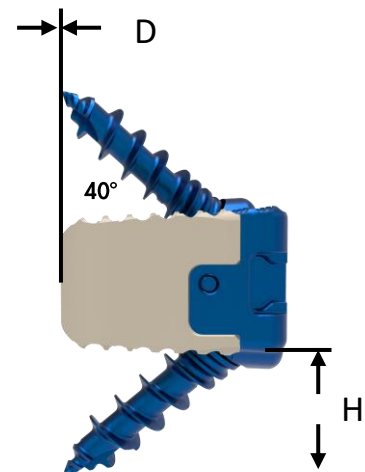

# SET CONFIGURATION 71-BK-0100













## INTEGRATED PLATE & CAGE INTERBODY

Item No.	Height*	Qty/Set	Locking Plate Color
<b>14mm x 12mm, 7°</b>			
71-AL-4206	6mm	3	Natural 
71-AL-4207	7mm	3	Dark Blue 
71-AL-4208	8mm	3	Gold 
71-AL-4209	9mm	2	Green 
71-AL-4210	10mm	2	Dark Purple 
71-AL-4211	11mm	1	Seafoam Green 
71-AL-4212	12mm	1	Magenta 
<b>16mm x 14mm, 7°</b>			
71-AL-6406	6mm	3	Natural 
71-AL-6407	7mm	3	Dark Blue 
71-AL-6408	8mm	3	Gold 
71-AL-6409	9mm	2	Green 
71-AL-6410	10mm	2	Dark Purple 
71-AL-6411	11mm	1	Seafoam Green 
71-AL-6412	12mm	1	Magenta 



\*Height does not include total teeth height of 0.8mm

## BONES SCREWS - T8 Interface

Item No.	Length	Qty/Set
<b>3.5mm Self-Drilling Screws</b> (minor Ø 1.9mm)		
71-DV-3512	12mm	6 
71-DV-3514	14mm	6 
71-DV-3515	15mm	6 
71-DV-3517	17mm	6 
<b>4.0mm Self-Drilling Screws</b> (minor Ø 2.4mm)		
71-DV-4012	12mm	6 
71-DV-4014	14mm	6 
71-DV-4015	15mm	6 
71-DV-4017	17mm	6 
<b>4.0mm Self-Tapping Screws</b> (minor Ø 2.4mm)		
71-TV-4012	12mm	6 
71-TV-4014	14mm	6 
71-TV-4015	15mm	6 
71-TV-4017	17mm	6 



# SET CONFIGURATION 71-BK-0100

## INSTRUMENTS

Item No.	Description	Qty/Set
71-CH-0001	AO Modular Handles	2
37-IN-0060	Screw/Locking Driver, T8	2
71-TN-7406	Trial, 14mm x 12mm, 5/6mm, 7°	1
71-TN-7408	Trial, 14mm x 12mm, 7/8mm, 7°	1
71-TN-7410	Trial, 14mm x 12mm, 9/10mm, 7°	1
71-TN-7412	Trial, 14mm x 12mm, 11/12mm, 7°	1
71-TN-7606	Trial, 16mm x 14mm, 5/6mm, 7°	1
71-TN-7608	Trial, 16mm x 14mm, 7/8mm, 7°	1
71-TN-7610	Trial, 16mm x 14mm, 9/10mm, 7°	1
71-TN-7612	Trial, 16mm x 14mm, 11/12mm, 7°	1
71-IN-0030	Drill Guide	1
71-SP-0212	AO Straight Drill - 12mm x 1.7mm	1
71-SP-0214	AO Straight Drill - 14mm x 1.7mm	1
71-SP-0215	AO Straight Drill - 15mm x 1.7mm	1
71-IN-0010	Straight Awl, 9mm x 1.7mm	1
71-IN-0720	Interbody Inserter	2
71-IN-0020	Angled Awl, 40°, 9mm x 1.7mm	1
71-IN-0410	AO Angled Drill - 12mm x 1.7mm	1
71-IN-0400	Angled Driver, 40°, T8	1
71-IN-0407	Counter Torque Handle	1
37-IN-0050	Tamp	1
37-IN-0084	Impaction/Extraction Mallet	1

### ANGLED INSTRUMENTS



71-IN-0020  
Angled Awl, 40°  
9mm x 1.7mm



71-IN-0410  
Angled Drill, 40°  
12mm x 1.7mm



71-IN-0400  
Angled Driver, 40°, T8



71-IN-0407  
Counter Torque



71-CH-0001  
Modular Handle



37-IN-0060  
Screw/Locking Driver, T8



71-TN-7406 to 71-TN-7412  
71-TN-7606 to 71-TN-7612  
Trials



71-IN-0010  
Straight Awl  
9mm x 1.7mm



71-IN-0720  
Interbody Inserter



71-IN-0030  
Drill Guide



71-SP-0212 to 71-SP-0215  
AO Drills



37-IN-0050  
Tamp



37-IN-0084  
Impaction/Extraction Mallet



# SET CONFIGURATION 71-BK-0100

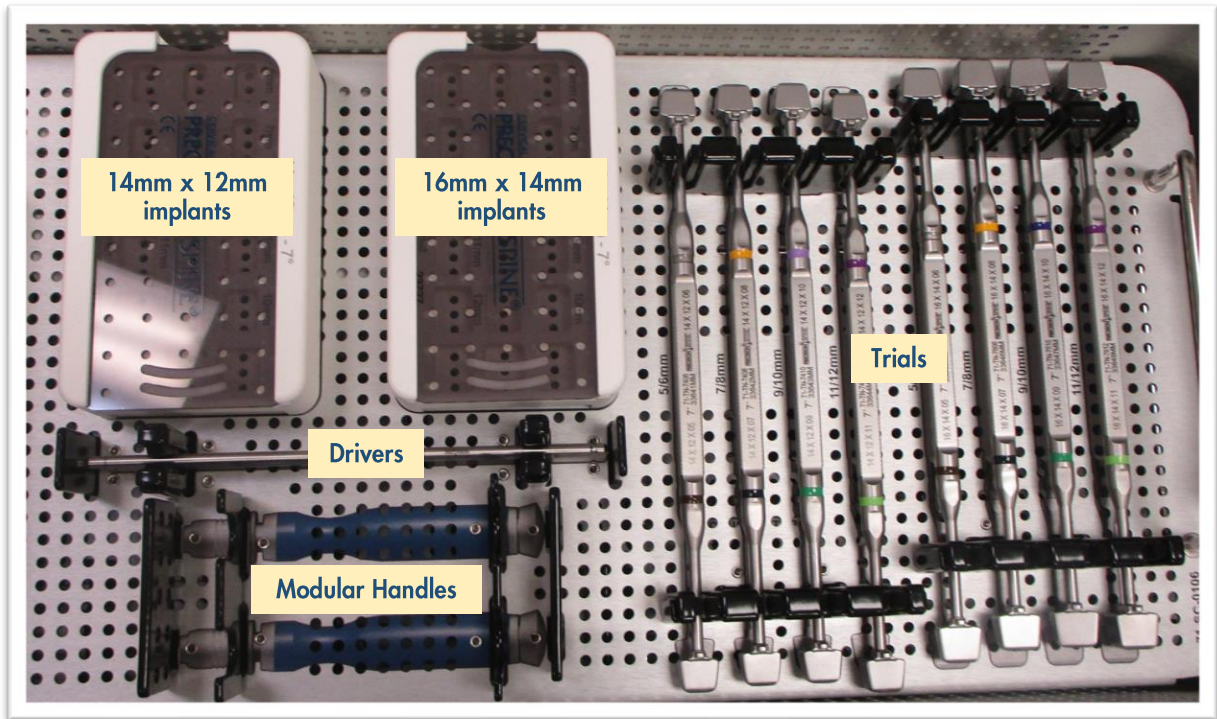

Item No.	Height	Qty/Set	Item No.	Description	Qty/Set
<b>14mm x 12mm, 7°</b>			71-CH-0001	AO Modular Handles	2
71-AL-4206	6mm	3	37-IN-0060	Screw/Locking Driver, T8	2
71-AL-4207	7mm	3	71-TN-7406	Trial, 14mm x 12mm, 5/6mm, 7°	1
71-AL-4208	8mm	3	71-TN-7408	Trial, 14mm x 12mm, 7/8mm, 7°	1
71-AL-4209	9mm	2	71-TN-7410	Trial, 14mm x 12mm, 9/10mm, 7°	1
71-AL-4210	10mm	2	71-TN-7412	Trial, 14mm x 12mm, 11/12mm, 7°	1
71-AL-4211	11mm	1	71-TN-7606	Trial, 16mm x 14mm, 5/6mm, 7°	1
71-AL-4212	12mm	1	71-TN-7608	Trial, 16mm x 14mm, 7/8mm, 7°	1
<b>16mm x 14mm, 7°</b>			71-TN-7610	Trial, 16mm x 14mm, 9/10mm, 7°	1
71-AL-6406	6mm	3	71-TN-7612	Trial, 16mm x 14mm, 11/12mm, 7°	1
71-AL-6407	7mm	3			
71-AL-6408	8mm	3			
71-AL-6409	9mm	2			
71-AL-6410	10mm	2			
71-AL-6411	11mm	1			
71-AL-6412	12mm	1			



# SET CONFIGURATION 71-BK-0100

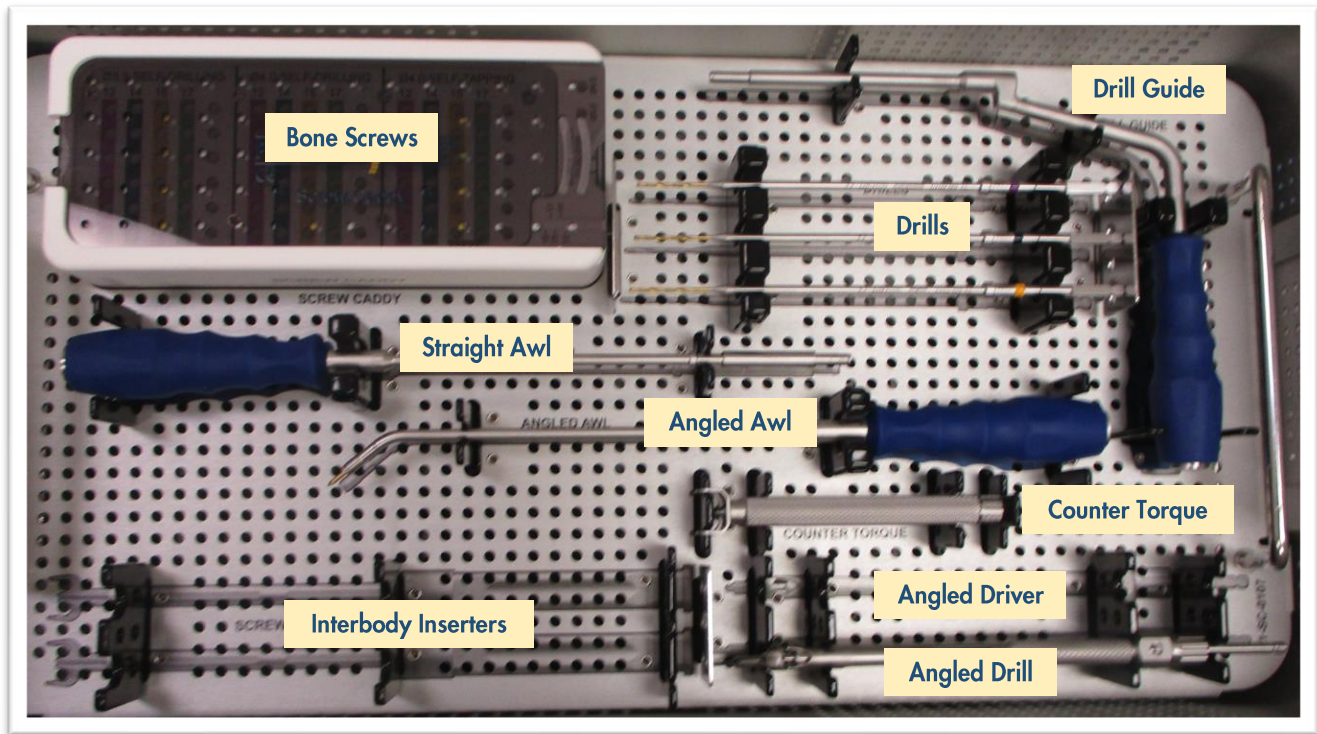

Item No.	Length	Qty/Set	Item No.	Description	Qty/Set
<b>3.5mm Self-Drilling Screws</b> (minor Ø 1.9mm)			71-IN-0030	Drill Guide	1
71-DV-3512	12mm	6	71-SP-0212	AO Straight Drill - 12mm x 1.7mm	1
71-DV-3514	14mm	6	71-SP-0214	AO Straight Drill - 14mm x 1.7mm	1
71-DV-3515	15mm	6	71-SP-0215	AO Straight Drill - 15mm x 1.7mm	1
71-DV-3517	17mm	6	71-IN-0010	Straight Awl, 9mm x 1.7mm	1
<b>4.0mm Self-Drilling Screws</b> (minor Ø 2.4mm)			71-IN-0720	Interbody Inserter	2
71-DV-4012	12mm	6	71-IN-0020	Angled Awl, 40°, 9mm x 1.7mm	1
71-DV-4014	14mm	6	71-IN-0410	AO Angled Drill - 12mm x 1.7mm	1
71-DV-4015	15mm	6	71-IN-0400	Angled Driver, 40°, T8	1
71-DV-4017	17mm	6	71-IN-0407	Counter Torque Handle	1
<b>4.0mm Self-Tapping Screws</b> (minor Ø 2.4mm)					
71-TV-4012	12mm	6			
71-TV-4014	14mm	6			
71-TV-4015	15mm	6			
71-TV-4017	17mm	6			

# SET CONFIGURATION 71-BK-0100

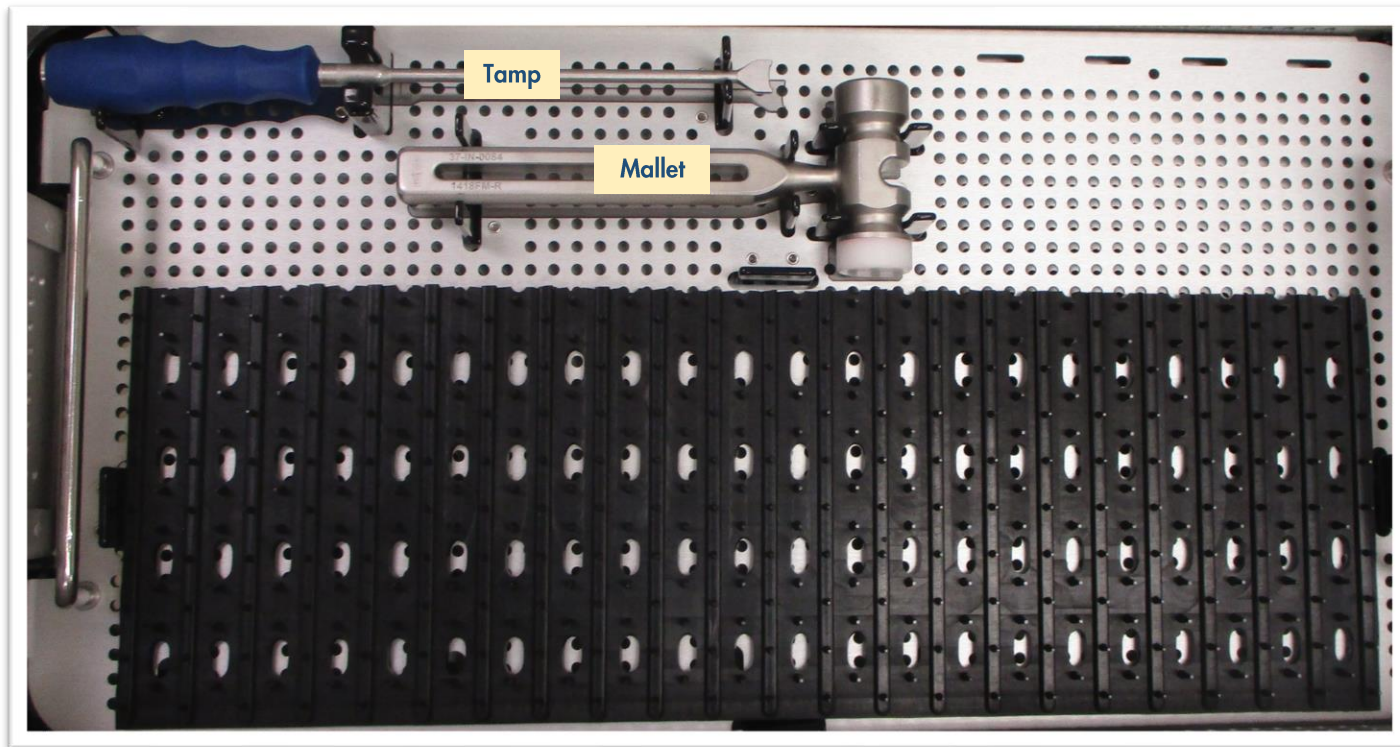

Item No.	Description	Qty/Set
37-IN-0050	Tamp	1
37-IN-0084	Impaction/Extraction Mallet	1

## By Request Instruments



71-IN-0415  
Angled Driver, Short Tip, 40°, T8  
*\*NOT COMPATIBLE with Interbody Inserters*



Item No.	Description	Qty/Set
71-RS-7406	Rasp, 14mm x 12mm, 5/6mm, 7°	1
71-RS-7408	Rasp, 14mm x 12mm, 7/8mm, 7°	1
71-RS-7410	Rasp, 14mm x 12mm, 9/10mm, 7°	1
71-RS-7412	Rasp, 14mm x 12mm, 11/12mm, 7°	1
71-RS-7606	Rasp, 16mm x 14mm, 5/6mm, 7°	1
71-RS-7608	Rasp, 16mm x 14mm, 7/8mm, 7°	1
71-RS-7610	Rasp, 16mm x 14mm, 9/10mm, 7°	1
71-RS-7612	Rasp, 16mm x 14mm, 11/12mm, 7°	1

# SURGICAL TECHNIQUE

## 1

### PATIENT POSITIONING

Carefully position the patient in a supine position on a radiolucent operating table. Ensure that the neck of the patient is in a sagittal, neutral position and supported with a cushion.

## 2

### EXPOSURE & DISTRACTION

Utilizing a standard anterior exposure, confirm the surgical level via fluoroscopy.

Perform segmental distraction. Distraction of the segment is essential for restoring disc height as well as for providing optimal access to the intervertebral space.

## 3

### ENDPLATE PREPARATION

When the discectomy is complete, remove the superficial layers of the cartilaginous endplates to expose bleeding bone. This can be accomplished with a variety of instruments, such as osteotomes, scrapers, curettes and rasps. Adequate preparation of the endplates is important to enhance vascular supply to the fusion site.

**Note: Excessive preparation may weaken the endplates and could result in subsidence.**

## 4

### INTERBODY SIZING

Selection of the proper interbody size is critical. Sequentially insert the Trials (71-TN-7XXX) into the disc space to determine the implant footprint, height, and lordosis. The trial should fit securely between the endplates (Figure 1).

Confirm proper sizing via fluoroscopy.

Rasps (71-RS-7XXX) may also be utilized to further prepare the endplate or determine interbody sizing (Figure 2).

**Note: All trials and rasps are the same dimensions as the interbody.**



Figure 1



Figure 2

# SURGICAL TECHNIQUE

## 5

### INTERBODY INSERTION

1. Select the appropriate interbody size determined by the trial.

Rotate the gold knob of the Interbody Inserter (71-IN-0720) counterclockwise to fully open the distal tip of the instrument (Figure 3).

Position the distal tips of the Inserter onto the sides of the selected interbody. While holding the interbody on the Inserter, rotate the gold Inserter knob clockwise to securely attach the interbody (Figure 4).

**Note: Do not overtighten the Inserter to the interbody.**

2. Insert bone graft into the center window of the interbody.

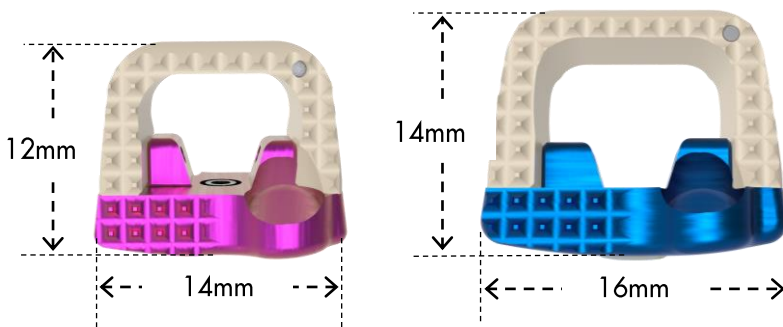
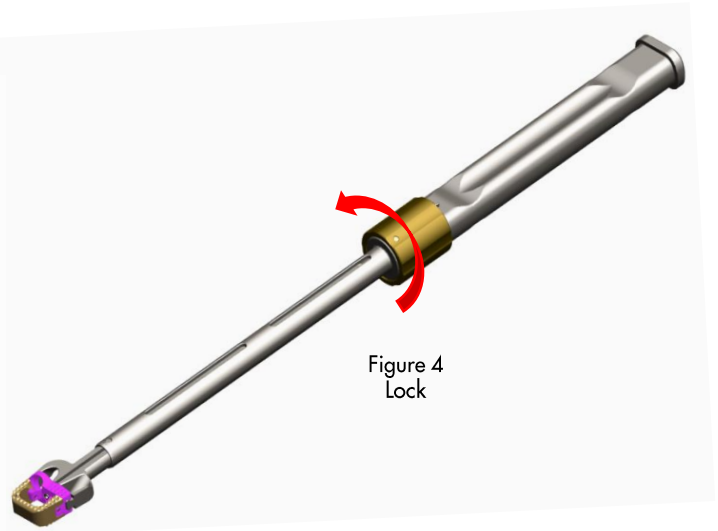
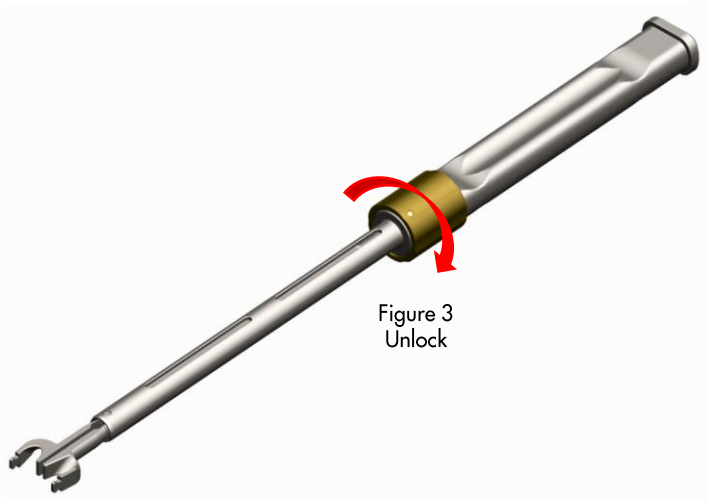

Interbody Height	Locking Plate Color
------------------	---------------------

6mm	Natural 
7mm	Dark Blue 
8mm	Gold 
9mm	Green 
10mm	Dark Purple 
11mm	Seafoam Green 
12mm	Magenta 



# SURGICAL TECHNIQUE

## 5 INTERBODY INSERTION (continued)

3. Insert the interbody into the disc space (Figure 5). The interbody plate should be flush with the anterior portion of the vertebral bodies.

If desired, the Inserter may be disengaged from the interbody by rotating the Inserter knob counterclockwise until it is free from the interbody. Final position of the interbody may be achieved by light, controlled impaction with the Tamp (37-IN-0050).

Confirm interbody position via fluoroscopy.

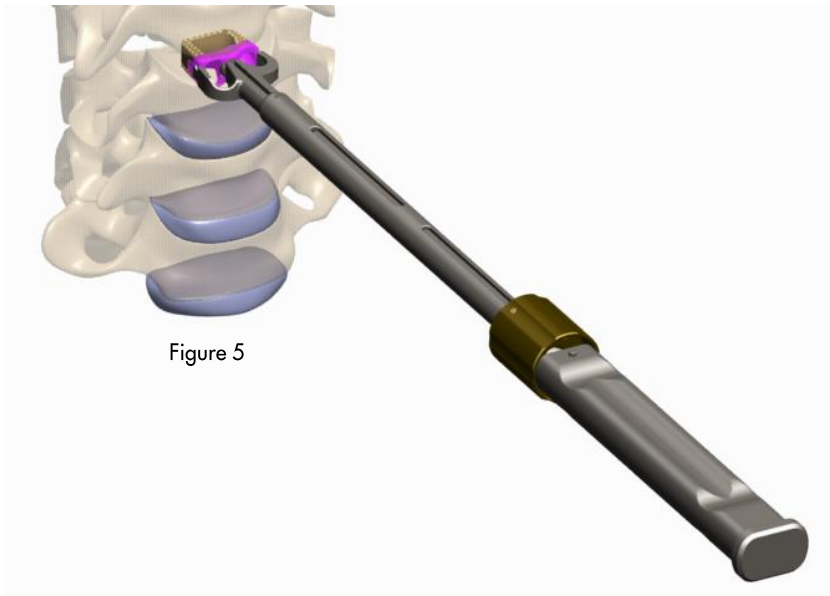
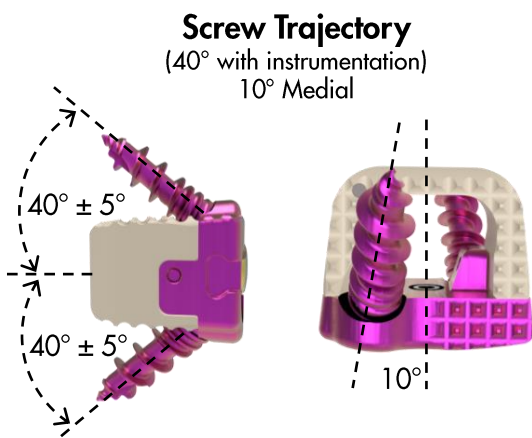

Figure 5



**Screw Engagement at 40°**

Screw Length (mm)	14mm x 12mm		16mm x 14mm	
	Depth (D)	Height (H)	Depth (D)	Height (H)
12	0-Flush	6.6	-2.0	6.6
14	1.0	7.7	0-Flush	7.7
15	2.0	8.9	1.0	8.9
17	3.5	10.0	2.0	10.0

**Note:** Awls and Drill Guide allow for a screw angulation of 40°. The total screw engagement with the vertebrae is dependent on the interbody footprint and bone screw length. Utilize the reference chart to determine screw length engagement when the screw is placed at 40°.

# SURGICAL TECHNIQUE

## 6

## SCREW HOLE PREPARATION

### 1. Straight Awl or Angled Awl

Create a pilot hole using the Straight (71-IN-0010, Figure 6) or Angled Awl (71-IN-0020, Figure 7). Firmly seat the Awl within the screw hole and press the Awl into the bone until the depth as bottomed out.

Awl Depth - 9mm  
Awl Diameter - 1.7mm  
Awl Angle - 40°

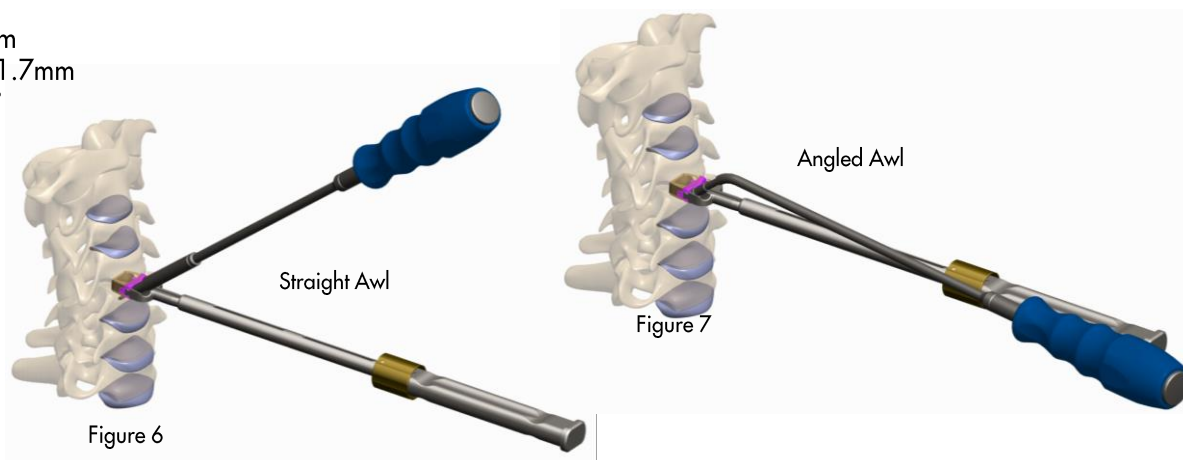

### 2. Drill and Drill Guide

Securely attach the desired Drill (71-SP-02XX) or Angled Drill\* (71-IN-0410) to the Modular Handle (71-CH-0001). Firmly seat the Drill Guide (71-IN-0030) within the screw hole. Insert the Drill (71-SP-02XX) into the Drill Guide and drill to the appropriate depth (Figure 8).

When used in conjunction with the Drill Guide, there is a positive stop on the Drill to prevent over-drilling.

Angled Drill (71-IN-0410) - For additional control, the Counter Torque (71-IN-0407) may be threaded into any of the mating holes on the Angled Drill.

*\*Angled Drill is NOT COMPATIBLE with Drill Guide.*

**Note: The trajectory and depth of drills and screws should be determined by fluoroscopy to ensure appropriate sizing for the anatomy.**

Drill Guide Angle - 40°

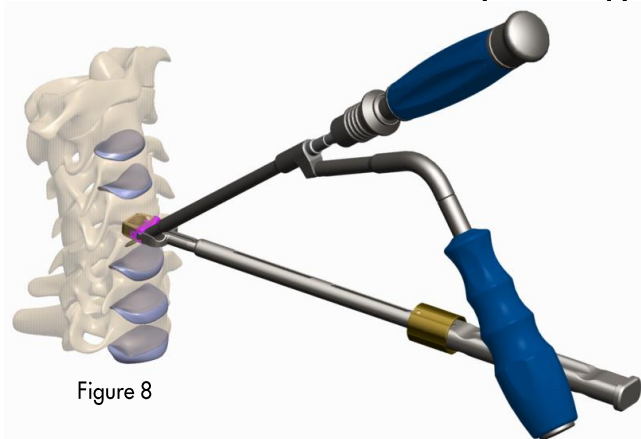



# SURGICAL TECHNIQUE

## 7

### SCREW INSERTION

#### 1. Straight Driver or Angled Driver

Securely attach the Straight Driver (37-IN-0060) or Angled Driver (71-IN-0400) to the Modular Handle (71-CH-0001). Insert the tip of the Driver firmly into the hexalobe of the desired bone screw (Figure 9).

Angled Driver (71-IN-0400) - For additional control, the Counter Torque (71-IN-0407) may be threaded into any of the mating holes on the Angled Driver.

**Note: The Driver tip must be completely seated into the hexalobe of the bone screw during insertion to ensure proper placement (Figure 9).**

Insert and firmly seat the bone screws into the interbody (Figure 10).

For proper engagement of the locking mechanism, ensure that all bone screws are completely seated within the bone screw holes.

Confirm interbody and bone screw positioning visually and via fluoroscopy.

#### Screw Lengths



Incorrect



Correct



Figure 9

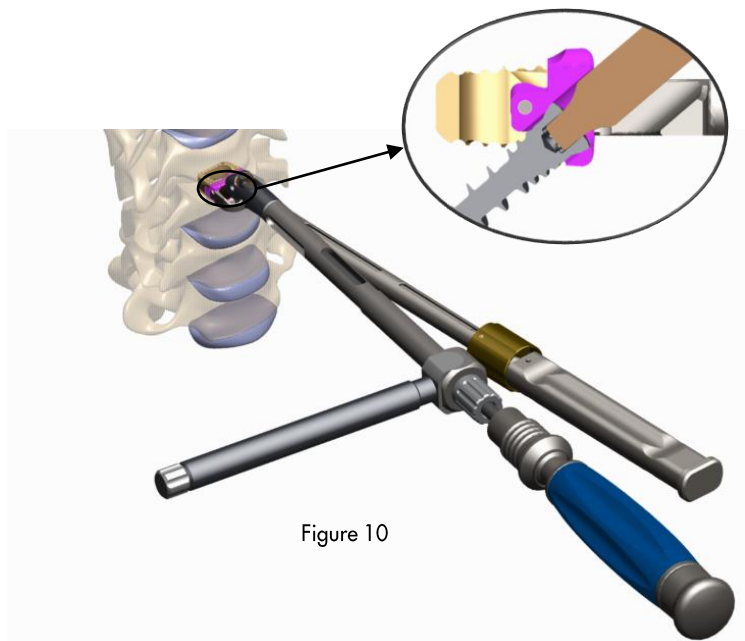

Figure 10

# SURGICAL TECHNIQUE

## 8

### LOCKING MECHANISM

Once the bone screws have been properly seated, positioned, and tightened, rotate the locking mechanism 90° to secure the seated bone screws within the interbody.

Insert the Driver (37-IN-0060) securely into the Modular Handle (71-CH-0001).

Seat the Driver tip securely and in-line into the locking mechanism and rotate clockwise 90° until it stops to properly lock the construct (Figure 11).

Do not rotate locking mechanism more than once as this will weaken it.

Visually and fluoroscopically confirm construct placement and locking mechanism prior to closure (Figure 12).

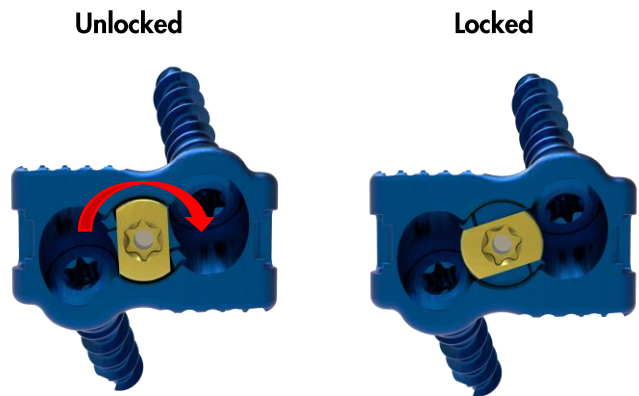

Figure 11

Distance from Tantalum marker to posterior wall = 1.6mm

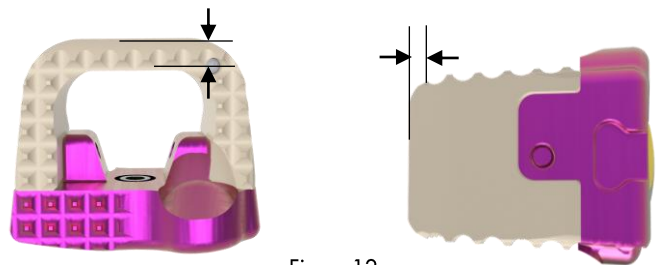

Figure 12

## 9

### IMPLANT REMOVAL

If required, the construct can be removed utilizing the Driver (37-IN-0060).

Insert the Driver (37-IN-0060) securely into the Modular Handle (71-CH-0001).

Seat the Driver tip securely and in-line into the locking mechanism and rotate counterclockwise until the bone screws can be removed (Figure 13).

To remove the bone screws, completely seat the tip of the Driver into the hexalobe of the bone screw. Turn the Driver counterclockwise to remove the bone screws.

Position the distal tips of the Inserter securely onto the sides of the interbody. Rotate the Inserter knob clockwise to securely attach the interbody. Attach the Extraction Mallet to the Inserter and remove the implant from the disc space.

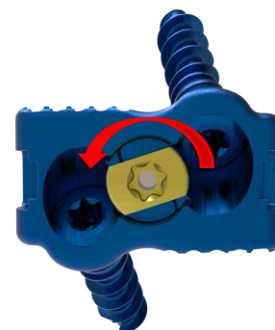

Figure 13

# Indications, Contraindications, Warnings, and Precautions

## INDICATIONS:

The **Dakota ACDF** System is a standalone cervical interbody device intended for use in skeletally mature patients with degenerative disc disease (DDD) of the cervical spine (C2-T1) at one- or two-disc levels. DDD is defined as discogenic pain with degeneration of the disc confirmed by history and radiographic studies. The **Dakota ACDF** implants are used with two titanium alloy screws and filled with autogenous bone graft material to facilitate fusion in the cervical spine. The device is placed via an anterior approach at the C2 to T1 disc levels. Patients should have at least six weeks of non-operative treatment prior to treatment with an intervertebral fusion device.

## PRECAUTIONS:

Based on the dynamic testing results, the physician should consider the levels of implantation, patient weight, patient activity level, and other patient conditions, etc., which may impact the performance of the intervertebral body fusion device.

The implantation of **Dakota ACDF** intervertebral fusion devices should be performed only by experienced spinal surgeons with specific training in the use of this system because this is a technically demanding procedure presenting risk of serious injury to the patient.

All system implants are single use only. Reuse of the device may result in the following:

1. Infection
2. Loosening
3. Fracture / mechanical failure of the device
4. Inability to properly engage surgical instrumentation
5. Pyrogenic reaction

## CONTRAINDICATIONS:

The **Dakota ACDF** System contraindications include, but are not limited to:

1. Prior fusion at the level(s) to be treated.
2. Any condition not described in the Indication for Use
3. Previous vascular approach
4. Iliofemoral arteriosclerosis
5. Morbid obesity
6. Mental illness
7. Pregnancy
8. Local infection or inflammation
9. Any case requiring the use of different metals from components
10. Any patient unwilling or unable to follow postoperative care instructions
11. All cases not stated in the Indications for Use
12. Reuse, or multiple uses

## POTENTIAL ADVERSE EFFECTS:

The following potential adverse effects associated with the procedure have been shown to occur with the use of similar spinal systems. All patients considered candidates for fusion should be informed concerning the pathogenesis of their spinal abnormality, the rationale for fusion with instrumentation, and the potential adverse effects. Potential adverse effects include, but are not limited to the following:

1. Loss of proper spinal curvature, correction, height, and/or reduction
2. Infection
3. Non-union or delayed union
4. Foreign body reaction to the implants
5. Hemorrhaging
6. Loss of neurological function, dural tear, pain, and/or discomfort
7. Bone graft fracture, vertebral body fracture or discontinued growth of fused at, above and/or below the surgery level
8. Bending, loosening, fracture, disassembly, slippage and/or migration of the components
9. Pain or discomfort
10. Change in mental status
11. Bursitis
12. Bone loss and/or bone fracture due to stress shielding
13. Inability to resume activities of normal daily activities
14. Revision surgery
15. Death

**Note: Additional surgery may be required to correct some of these potential adverse events.**

## WARNINGS:

The following are warnings for this device.

1. Patients with previous spinal surgery at the level(s) to be treated may have different clinical outcomes compared to those without previous surgery.
2. Potential risks identified with the use of this device system, which may require additional surgery, include device component fracture, loss of fixation, non-union, fracture of the vertebrae, necrosis of the bone, neurological injury, and/or vascular or visceral injury.
3. The benefit of spinal fusions utilizing any interbody fusion device has not been adequately established in patients with stable spines.
4. Patient selection and compliance will greatly affect the results. Patients suffering from obesity, malnutrition, and/or poor bone quality are poor candidates for spinal fusion. Patients who smoke, or abuse alcohol, are poor candidates for spinal fusion.
5. Patients who smoke should be advised of the consequences of the fact that an increased incidence of non-union has been reported with patients who smoke.
6. The implants and instruments are provided non-sterile and must be cleaned and sterilized before use. Device components should be sterilized using one of the noted validated sterilization cycle parameters.
7. A successful result is not always achieved in every surgical case due to many extenuating circumstances. This is especially true in spinal surgeries where other patient conditions may compromise the results.
8. Only surgeons trained and experienced in spinal decompression and bone grafting techniques should use the **Dakota ACDF**™ System. Preoperative and operating procedures, including knowledge of surgical techniques and proper selection and placement of the implants, are essential considerations in the utilization of this device.
9. Physician note: Although the physician is the learned intermediary, the important medical information given in this document should be conveyed to the patient.
10. Do not reuse implants. Discard used, damaged, or otherwise suspect implants. **AN IMPLANT SHOULD NEVER BE RE-USED.** Any implant, once used, should be discarded. Even though it appears undamaged, it may have small defects and internal stress patterns that may lead to failure. These Single Use devices have not been designed to undergo or withstand any form of alteration, such as disassembly, cleaning, or re-sterilization, after a single patient use. Reuse can potentially compromise device performance and patient safety.



**Precision Spine, Inc.**

2050 Executive Drive, Pearl, MS 39208

Customer Service: 1.888.241.4773

Phone: 601.420.4244

Toll Free: 877.780.4370

Fax: 601.420.5501

[www.precisionspineinc.com](http://www.precisionspineinc.com)

Caution: Federal (USA) law restricts these devices to sale by, or on the order of, a physician.  
Dakota ACDF™ and Precision Spine® are trademarks of Precision Spine, Inc.  
Copyright 2021 Precision Spine, Inc. All rights reserved. P/N LBL-STG-047 Rev C 04/2021

**CE 2797**