

## LEANDER®

Cervical vertebral body replacement



## Content

About us	03
System	04
Specific advantages of our products	05
Surgical technique	06
Representation of the relationship between trial implant and implant	12
Plate combination options with resulting implant heights	13
Implants	14
Instruments	16
Contact	20

## About us



The German family company Human Tech Spine is based in Baden Württemberg and develops, manufactures and sells high-quality and innovative spinal systems worldwide.

Our traditional corporate group was founded in 1948 and is a reliable employer for around 500 employees. It has a production area of around 15,000 m<sup>2</sup>, and our entire product portfolio is manufactured there. Our high-tech production facilities as well as the most advanced, environmentally friendly production and logistics processes guarantee high-quality and on-time production and delivery processes.

The independent medical division has two main focuses (Spine and Dental) and was founded in 2010. It is now well represented and respected on the national and international markets. Together with renowned spinal surgeons, our development team breaks new ground every day to ensure that every patient receives uncompromising high-quality care. The design of our systems is aimed at providing maximum user-friendliness, security and integrity.

That's why HumanTech Spine is regarded as a reliable partner in the fields of spinal research, development, production and marketing as well as advanced training by members of our HumanTech Academy. Our one-stop source. This is how we ensure that our quality is 100% 'Made in Germany'.

## System

The LEANDER® vertebral body replacement is an implant system that is suitable for long-term use in anterior stabilisation of the cervical spine; it can replace one or more vertebral bodies in patients whose general skeletal growth has ceased.

The system is intended for surgical treatment of tumorous, inflammatory and traumatic diseases as well as injuries of the cervical spine (C3 to C7) leading to instability in the area of anterior support or compression of neural structures that make sanitation of infections necessary.

The LEANDER® system is intended for use with an additional ventral fixation system, e.g. HERO®.

The system consists of implant bodies and implant end plates in various dimensions. Implant bodies are available in various heights for different defect extents. For adaptation to different vertebral body structures and to enable correction of existing or desired lordotic or kyphotic curvatures of the spinal column, the implant end plates are provided in several widths and angulations. The patient's unique anatomy can be taken into account by connecting the various implant components to one another with plate-retaining screws.

All components of the LEANDER® vertebral body replacement system are made of the titanium alloy Ti6Al4V, which has been tried and tested for many years in the field of implantology.

The clearly arranged set of instruments has been tailored to the needs of the surgeon.

Thanks to certain special features, LEANDER® offers outstanding advantages for each of our products:

### Anatomical:

- Generous contact surface of the end plates

### Stable:

- Pyramidal tooth profile for primary fixation to the bony structure of the vertebral body endplates
- Connection of the end plates to the implant body with anti-rotation protection

### Flexible:

- Optimal adaptability to the patient's anatomy
- Various base heights
- Various end plate widths and angles can be combined freely
- Completely reversible

### Integral:

- Blasted and etched surfaces of the end plates designed to support direct growth of the bone onto the implant

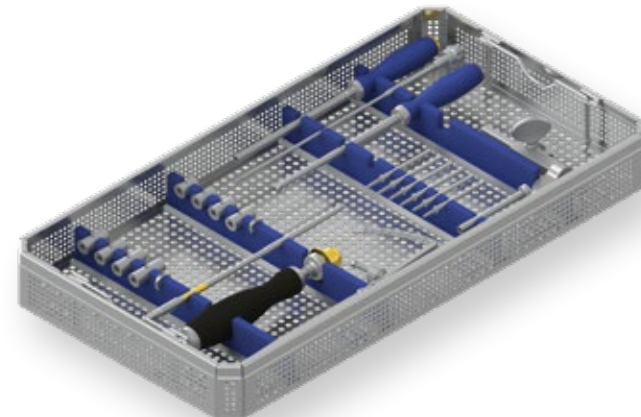

# LEANDER®

Cervical vertebral body replacement



## Four outstanding product properties

- 1 Pyramidal tooth profile for primary fixation to the bony structure of the vertebral body endplates
- 2 Generous contact surface of the end plates
- 3 Completely reversible
- 4 Blasted and etched surfaces of the end plates designed to support direct growth of the bone onto the implant





## Surgical technique



### Enabling access and removal of the vertebral body

After access has been prepared, a partial or complete corpectomy is performed with the appropriate instruments, depending on the anatomy and the clinical picture. Careful preparation is necessary to ensure the insertion and correct positioning of the implant.

The adjacent intervertebral discs are then removed and the surface of the end plates of the adjacent vertebral bodies is treated.

#### Attention:

Care must be taken to ensure that the end plates of the adjacent vertebral bodies remain intact. Damage to the end plates or excessive wear of the end plates can lead to sintering in of the implant and loss of segmental stability.

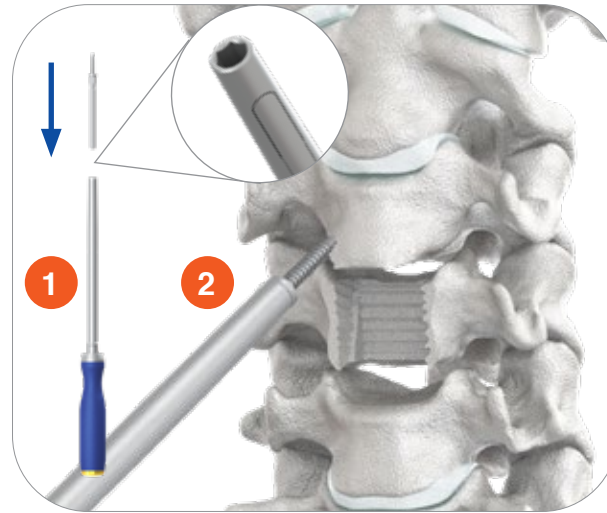

### Insertion of the distraction pins I

The correct length of the distraction pins is determined from the X-ray image before insertion. The distraction pin is inserted from below into the tip of the pindriver until it is locked in place by the retaining spring on the pindriver.

For correct positioning of the distraction pin in the pindriver, alignment of the hexagonal geometries must be ensured (1). The distraction pins are then placed in the vertebrae located caudal and cranial to the defect to be treated (2). It is important to ensure that the distraction pins are positioned as centrally as possible in the vertebral body.

With osteoporotic bone, the distraction pins can also be inserted near the end plates in order to achieve better and more secure anchoring and expansion stability.



### Insertion of the distraction pins II

After the distraction pin has been screwed in, the pindriver is carefully pulled posteriorly.

#### Attention:

The distraction pins must not perforate the posterior margin of the vertebral body. The distraction pins must not be inserted into a previously used hole. Otherwise the grip of the bone on the distraction pins is reduced, and they may be pulled out of the bone when the pindriver is removed. The distraction pins are only intended for single use.

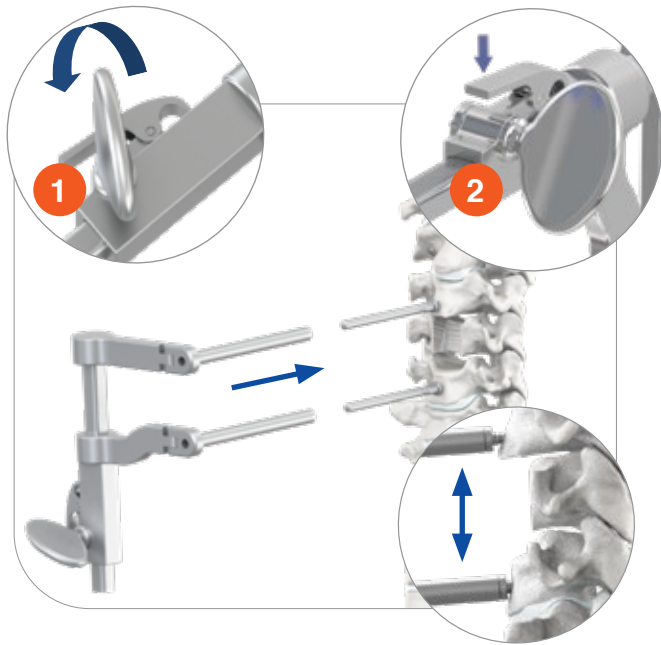

### Placement of the vertebral body spreader and spreading of defect

The Retrival Body Retractor is applied from above to the protruding ends of the distraction pins. Then the defect is carefully expanded by turning the adjusting wheel counterclockwise (1) on the vertebral body spreader, thus showing the defect up to the posterior margin.

**Note:**

The set expanded position of the vertebral body spreader is held in place by a locking mechanism. The lever (2) on the instrument must be actuated to release or correct the expanded position.

### Surgical technique

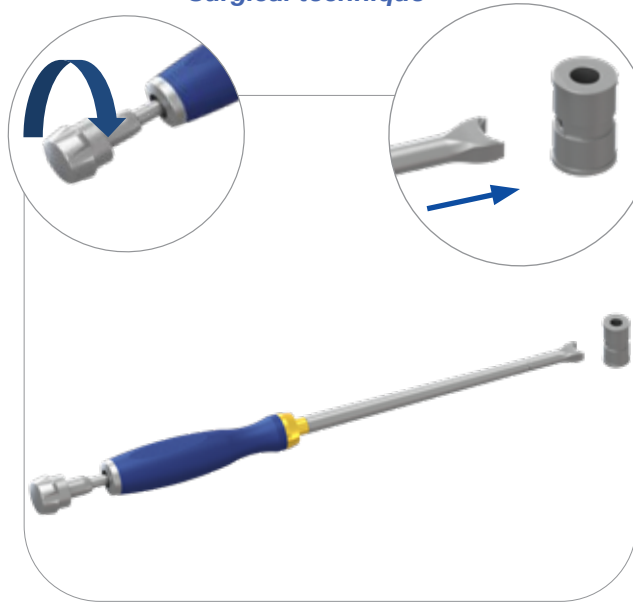

### Determination of the implant size up to size 30 - assembly of trial implant

With the help of the trial implants (Leander Trial), an implant size of up to 30 mm can be determined under radiographic control. In order to connect the trial implant to the insertion instrument (Leander Inserter), the bar of the insertion instrument must be positioned in the groove of the trial implant. By screwing the inner part of the insertion instrument (Tristan Inserter B) clockwise into the thread of the trial implant, the insertion instrument is fixed to the trial implant.

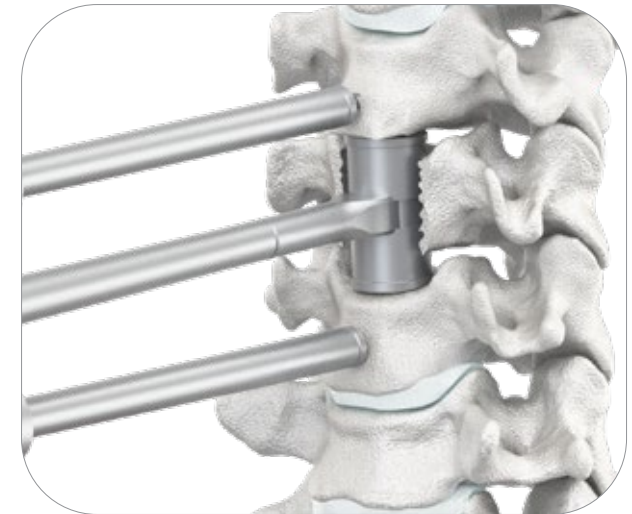

### Determination of the implant size up to size 30 - insertion of the trial implant

The trial implant is then inserted into the defect. The trial implants must be hammered in gently.

The trial implant should fit into the prepared defect as snugly as possible; further preparation may be required until the desired fit is achieved.

Once the size has been determined, the trial implant is removed from the defect.

**Note:**

When using the 0° plates, the implant size should be determined using the measuring compass under X-ray control (see page 8).

The exact dimensional relationship between the trial implant and the implant is explained in more detail on pages 12-13. If the corresponding trial implant is too large for the defect, the next smaller size must be tried.

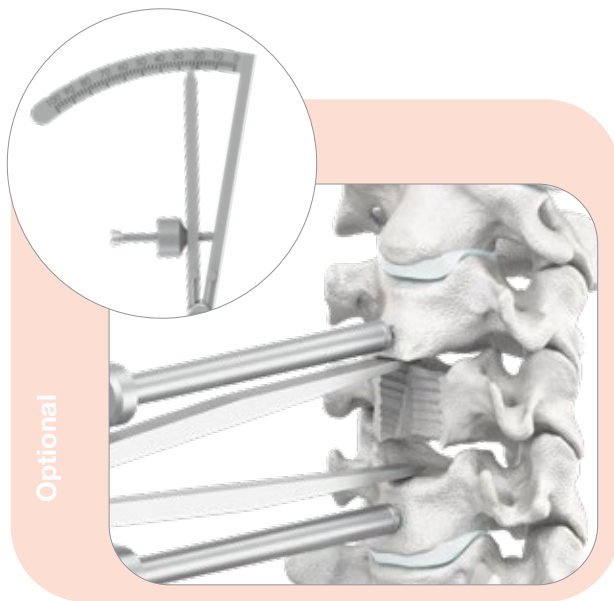

### Determination of the implant larger than size 30

The implant size to be selected for a size of 30 mm or greater can be determined under radiographic control with the aid of the measuring compass. To do this, the adjusting wheel on the side of the measuring compass must first be opened by turning it counterclockwise. The posterior arms of the compass are then pressed together manually and held. Now the measuring compass is positioned in the defect, and by releasing the hold on the rear arms of the measuring compass, the tips of the measuring compass will lie against the end plates of the vertebral bodies adjacent to the defect.

Care must be taken to ensure that the tips of the measuring compass are in firm contact with the end plates of the vertebral bodies in order to avoid inaccurate measurement. To do this, it may be necessary to readjust the position of the adjusting wheel on the side of the measuring compass. The distance compass between the anterior tips and thus the necessary implant size can be read from the scale at the posterior end of the measuring compass. It is advisable to close the measuring compass before removing it from the defect. The position determined for the size of the implant can be secured with the adjusting wheel on the side of the measuring compass.

### Surgical technique

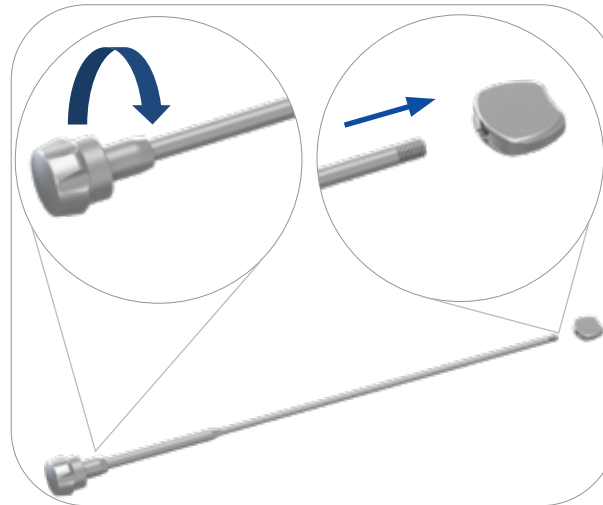

### Determination of the end plate size – Installation of the trial implants for the end plates

With the aid of the trial implants for the end plates (Leander Plate Trial) the size of the implant end plate to be selected can be determined under radiographic control. The thread of the internal part of the insertion tool (Tristan Inserter B) is screwed clockwise into the thread of the trial implant for the end plates.

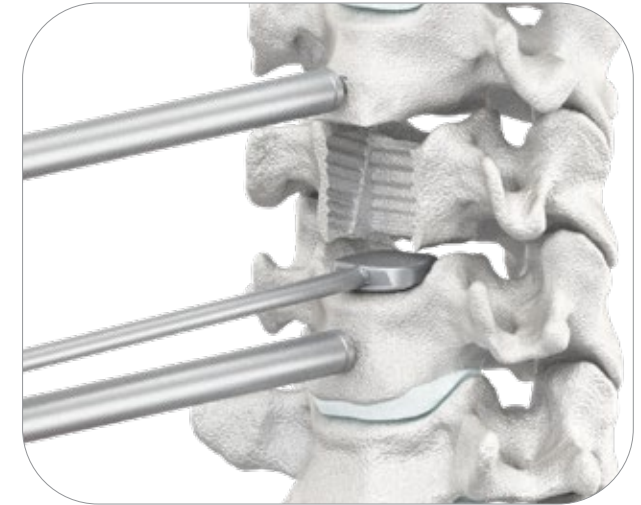

### Determination of the end plate size

After the insertion instrument has been installed, the trial implant for the end plates is inserted into the space created. The correct fit of the trial implant for the end plates is achieved when the anterior margin of the trial implant is about 1-2 mm posterior to the anterior margin of the vertebral bodies and the length is about 4/5 of the antero-posterior extent of the defect, and ends anterior to the posterior margin of the adjacent vertebral body.

The required sagittal angle of the implant's end plate is determined under radiographic control. Once the size has been determined, the trial implant is removed from the defect.

#### Note:

The size of the implant end plates should be selected to use the maximum contact surface of the vertebral body. This ensures the greatest possible stability and counteracts sintering in. However, the implant end plates should not protrude beyond the vertebral body, in order to avoid injury of adjacent structures. The trial implants as well as the implant end plates are available in two 'footprints' (12 x 14 and 14 x 16).



## Surgical technique



### Removal of the implant from the sterile packaging – removal of the outer blister from the transport box

The implants are provided in sterile packaging. In order to install the implant, the packaging of the implant body (VBR-C sterile) corresponding to the trial implant must be selected. Then the flap of the transport box that is closed with the label is opened and the blister inside is removed. This blister is the sterile barrier.

#### Attention:

The implants may only be used if the label on both the outer and the inner packaging are intact. If the packaging is damaged or has already been opened, sterility is not guaranteed and the implant must not be used.

The implants must not be used if the specified expiry date has been exceeded.

The sterile packaging must only be opened immediately before the implant is inserted.

Aseptic conditions must be maintained when removing the implant from the sterile packaging.



### Removal of the implant from the sterile packaging – removal of the inner blister from the outer blister

After removing the outer blister from the transport box, the sealed Tyvek lid of the blister is opened completely (starting at the front flap) and the inner blister is taken into the aseptic work area.

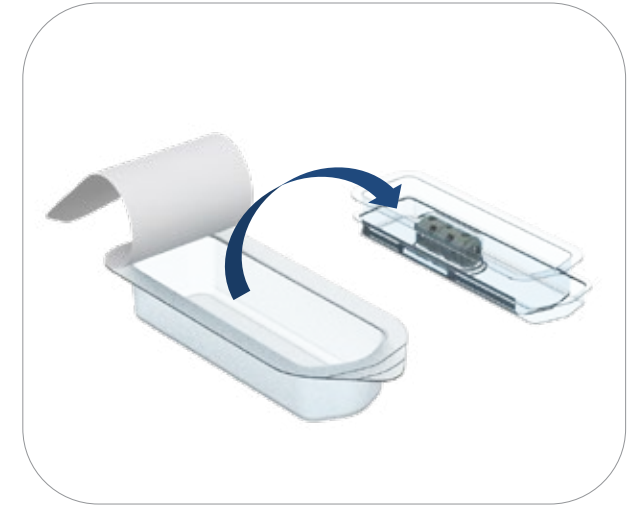

### Removal of the implant from the sterile packaging - removal of the skin insert from the inner blister

The sealed Tyvek lid of the inner blister is opened (starting at the front flap). The skin inlay located in the inner blister and used to hold the implant component is then removed from the inner blister together with the associated bottom insert.

#### Note:

The skin insert prevents the sterile items from moving in the inner blister of the sterile packaging during transport. The bottom insert provides additional protection for the sterile barrier.

## Surgical technique

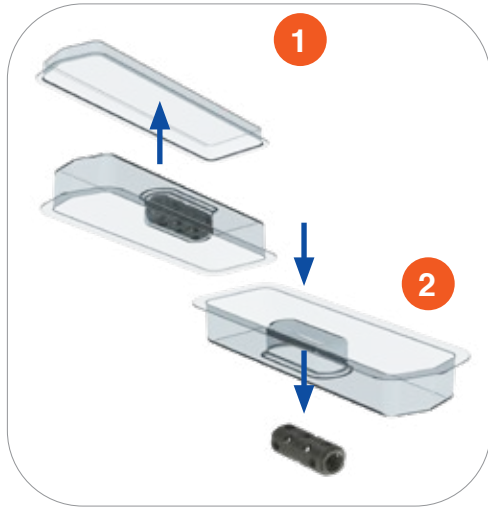

**Removal of the implant from the sterile packaging - removal of the implant from the skin insert**

The inferior insert is detached from the skin insert (1) and the implant component is removed from the skin insert (2).

**Note:**

All further implant components required for installing the implant are then removed from their sterile packaging. Removal from the sterile packaging is identical for all implant components.

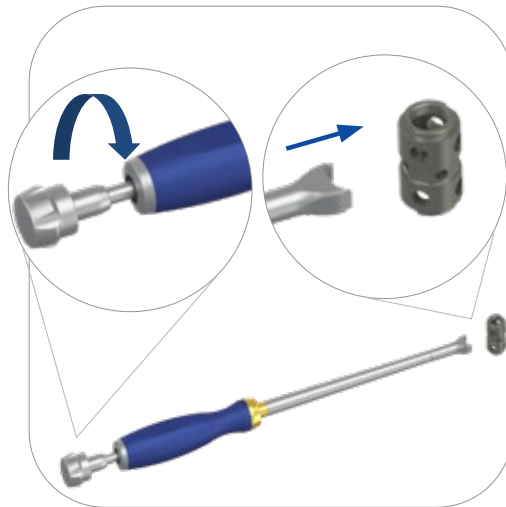

**Connection of the implant body with the insertion tool**

In order to connect the implant body to the insertion instrument Leander Inserter, the bar of the insertion instrument must be positioned in the groove of the implant body. The insertion instrument is fixed to the implant body by screwing the inner part of the insertion instrument Tristan Inserter B clockwise into the thread of the implant body.



**Attachment of the end plates**

The Torque Driver - 2,3 is connected to the LP Setscrew Driver (1).

The selected implant end plates are placed on the profile of the implant body. Care must be taken to ensure that the implant end plates are correctly allocated to the cranial and caudal ends of the implant body.

The implant end plates are attached to the implant body with the plate screw (Plate Screw – C sterile) (2). The plate retaining screw is inserted with the aid of the mounted screwdriver and fixed by screwing it in clockwise until the torque driver (2.3 Nm) is released (click), see also the note on the cap of the torque driver (3).

**Comment:**

The implant end plates must be connected to the implant body without any play. The implant end plates can only be placed on the implant body in one position.



**Insertion of the implant**

The pre-mounted implant attached to the insertion instrument is inserted, and the position of the implant is checked with radiography. The correct fit of the implant is achieved when the anterior margin of the implant is about 1-2 mm posterior to the anterior margin of the vertebral bodies and the length is about 4/5 of the antero-posterior extent of the defect, and ends anterior to the posterior margin of the adjacent vertebral body.

It is important to ensure that the implant end plates lie as flat as possible against the end plates of the vertebral body.

Once the implant has been placed in the intended position, the screw connection to the implant can be loosened and the insertion instrument removed by rotating the handle located on the inner part of the insertion instrument in an anti-clockwise direction.

## Surgical technique

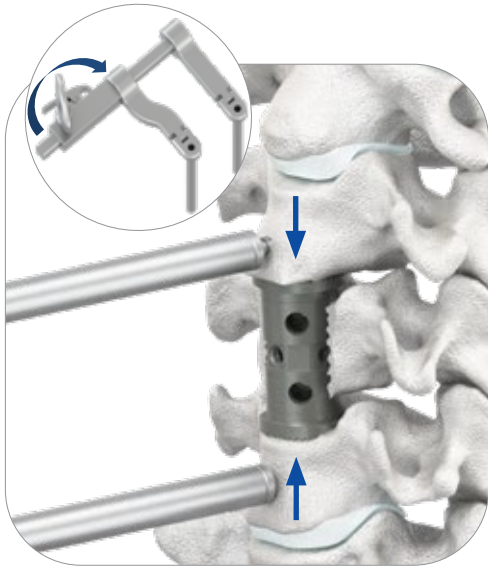

**Compression of the vertebral bodies**

After inserting the implant in its final position, it must be ensured that the pyramidal teeth penetrate into the upper and lower surfaces of the adjacent vertebral bodies by compressing the adjacent vertebral bodies with the vertebral body spreader.

### **Comment:**

In order to apply compression with the vertebral body spreader, the release of the locking mechanism must be held down. The adjacent vertebral bodies can then be pressed towards each other by turning the setting wheel counter to the direction of distraction until the pyramidal teeth penetrate the lower and upper surfaces of the adjacent vertebral bodies. Alternatively, the legs of the instrument can be carefully pressed together by hand while keeping the unlocking button pressed.



**Removal of the vertebral body spreader and distraction pins**

The vertebral body spreader and the distraction pins are then removed. To do this, the pindriver is pushed onto the respective distraction pin as far as it will go. It is important to ensure that the hexagonal geometries are correctly aligned. The distraction pin is secured against loss by the retaining spring in the pindriver.



**Subsequent installation of the insertion tool**

The insertion instruments can be placed on the implant again for any position corrections.

To do this, the bar of the insertion instrument must be positioned in the groove of the implant. The insertion tool is fixed to the implant by screwing the inner part of the insertion tool Tristan Inserter B clockwise into the implant.

If it is difficult to attach the implant or the connection to the instrument is not correct, the insertion instrument must be placed on the implant again. The instrument can be pulled to check that it is correctly attached.

### **Attention:**

To correct the position of the implant, the adjacent vertebral bodies must be distracted again with the vertebral body spreader.



**Final construction**

The LEANDER® vertebral body replacement is finally placed in the corpectomy gap. Additional anterior fixation (e.g. with the HERO® plate system) is necessary. A final check of the procedure is carried out with radiographic control images at two levels.

Finally, the surgical field is cleaned and the wound is closed.

Figure showing relationship between trial implant and implant (e.g. with a LEANDER VBR-C 22mm as an example)

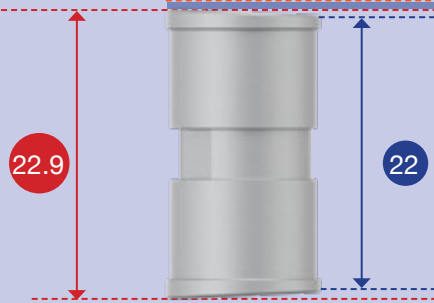
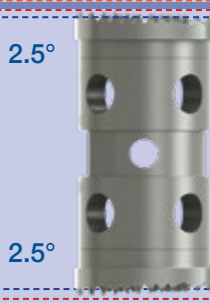
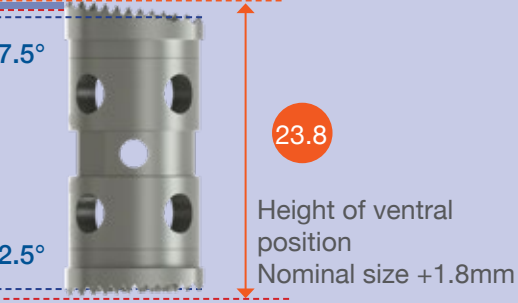
Figure:	Leander Trial	Implant with two 2.5°-angled end plates	Implant with higher angled end plates																								
<p>Note:</p>	<p>Trial implants represent the mounted implants <b>with two 2.5° end plates, including teeth</b>. Due to the angle, the ventral height is <b>0.9 mm</b> higher than the specified nominal dimension.</p>	<p>The nominal size of the implant is measured at the dorsal margin. The height at the ventral margin depends on the mounted end plates.</p>	<p>Angled end plates <b>add height</b> at the highest (ventral) position</p> <table border="1" data-bbox="1608 687 2123 946"> <thead> <tr> <th>Angle</th> <th>Total</th> <th>Height of ventral position</th> </tr> </thead> <tbody> <tr> <td>0°/0°</td> <td>0°</td> <td>Nominal Size</td> </tr> <tr> <td>0°/ 2,5°</td> <td>2,5°</td> <td>Nominal Size +0,5 mm</td> </tr> <tr> <td>0°/5° = 5°/0° = 2,5°/2,5°</td> <td>5°</td> <td>Nominal Size +0,9 mm</td> </tr> <tr> <td>0°/7,5° = 7,5°/0° = 2,5°/5° = 5°/2,5°</td> <td>7,5°</td> <td>Nominal Size +1,4 mm</td> </tr> <tr> <td>2,5°/7,5° = 7,5°/2,5° = 5°/5°</td> <td>10°</td> <td>Nominal Size +1,8 mm</td> </tr> <tr> <td>5°/7,5° = 7,5°/5°</td> <td>12,5°</td> <td>Nominal Size +2,3 mm</td> </tr> <tr> <td>7,5°/7,5°</td> <td>15°</td> <td>Nominal Size +2,7 mm</td> </tr> </tbody> </table>	Angle	Total	Height of ventral position	0°/0°	0°	Nominal Size	0°/ 2,5°	2,5°	Nominal Size +0,5 mm	0°/5° = 5°/0° = 2,5°/2,5°	5°	Nominal Size +0,9 mm	0°/7,5° = 7,5°/0° = 2,5°/5° = 5°/2,5°	7,5°	Nominal Size +1,4 mm	2,5°/7,5° = 7,5°/2,5° = 5°/5°	10°	Nominal Size +1,8 mm	5°/7,5° = 7,5°/5°	12,5°	Nominal Size +2,3 mm	7,5°/7,5°	15°	Nominal Size +2,7 mm
Angle	Total	Height of ventral position																									
0°/0°	0°	Nominal Size																									
0°/ 2,5°	2,5°	Nominal Size +0,5 mm																									
0°/5° = 5°/0° = 2,5°/2,5°	5°	Nominal Size +0,9 mm																									
0°/7,5° = 7,5°/0° = 2,5°/5° = 5°/2,5°	7,5°	Nominal Size +1,4 mm																									
2,5°/7,5° = 7,5°/2,5° = 5°/5°	10°	Nominal Size +1,8 mm																									
5°/7,5° = 7,5°/5°	12,5°	Nominal Size +2,3 mm																									
7,5°/7,5°	15°	Nominal Size +2,7 mm																									
<p>Visualization of a LEANDER VBR-C 22 mm with 2.5° and 7.5° end plate</p>																											

--> All unmarked values are in millimeters  
 --> Images are not to scale

Plate combination options with resulting implant heights

Type	Teeth	0°/0°		0°/2,5° 2,5°/0°		0°/5° 2,5°/2,5° 5°/0°		0°/7,5° 2,5°/5° 5°/2,5° 7,5°/0°		5°/5° 2,5°/7,5° 7,5°/2,5°		5°/7,5° 7,5°/5°		7,5°/7,5°		associated trial implant	Height of the associated trial implant	
		ventral	dorsal	ventral	dorsal	ventral	dorsal	ventral	dorsal	ventral	dorsal	ventral	dorsal	ventral	dorsal		ventral	dorsal
VBR – C 16 mm sterile	including teeth	16,0 mm	16,0 mm	16,5 mm	16,0 mm	16,9 mm	16,0 mm	17,4 mm	16,0 mm	17,8 mm	16,0 mm	18,3 mm	16,0 mm	18,7 mm	16,0 mm	Leander Trial 16mm	16,8 mm	15,9 mm
	excl. teeth	14,5 mm	14,5 mm	15,0 mm	14,5 mm	15,4 mm	14,5 mm	15,9 mm	14,5 mm	16,3 mm	14,5 mm	16,8 mm	14,5 mm	17,2 mm	14,5 mm			
VBR – C 18 mm sterile	including teeth	18,0 mm	18,0 mm	18,5 mm	18,0 mm	18,9 mm	18,0 mm	19,4 mm	18,0 mm	19,8 mm	18,0 mm	20,3 mm	18,0 mm	20,7 mm	18,0 mm	Leander Trial 18mm	18,8 mm	17,9 mm
	excl. teeth	16,5 mm	16,5 mm	17,0 mm	16,5 mm	17,4 mm	16,5 mm	17,9 mm	16,5 mm	18,3 mm	16,5 mm	18,8 mm	16,5 mm	19,2 mm	16,5 mm			
VBR – C 20 mm sterile	including teeth	20,0 mm	20,0 mm	20,5 mm	20,0 mm	20,9 mm	20,0 mm	21,4 mm	20,0 mm	21,8 mm	20,0 mm	22,3 mm	20,0 mm	22,7 mm	20,0 mm	Leander Trial 20mm	20,8 mm	19,9 mm
	excl. teeth	18,5 mm	18,5 mm	19,0 mm	18,5 mm	19,4 mm	18,5 mm	19,9 mm	18,5 mm	20,3 mm	18,5 mm	20,8 mm	18,5 mm	21,2 mm	18,5 mm			
VBR – C 22 mm sterile	including teeth	22,0 mm	22,0 mm	22,5 mm	22,0 mm	22,9 mm	22,0 mm	23,4 mm	22,0 mm	23,8 mm	22,0 mm	24,3 mm	22,0 mm	24,7 mm	22,0 mm	Leander Trial 22mm	22,8 mm	21,9 mm
	excl. teeth	20,5 mm	20,5 mm	21,0 mm	20,5 mm	21,4 mm	20,5 mm	21,9 mm	20,5 mm	22,3 mm	20,5 mm	22,8 mm	20,5 mm	23,2 mm	20,5 mm			
VBR – C 24 mm sterile	including teeth	24,0 mm	24,0 mm	24,5 mm	24,0 mm	24,9 mm	24,0 mm	25,4 mm	24,0 mm	25,8 mm	24,0 mm	26,3 mm	24,0 mm	26,7 mm	24,0 mm	Leander Trial 24mm	24,8 mm	23,9 mm
	excl. teeth	22,5 mm	22,5 mm	23,0 mm	22,5 mm	23,4 mm	22,5 mm	23,9 mm	22,5 mm	24,3 mm	22,5 mm	24,8 mm	22,5 mm	25,2 mm	22,5 mm			
VBR – C 26 mm sterile	including teeth	26,0 mm	26,0 mm	26,5 mm	26,0 mm	26,9 mm	26,0 mm	27,4 mm	26,0 mm	27,8 mm	26,0 mm	28,3 mm	26,0 mm	28,7 mm	26,0 mm	Leander Trial 26mm	26,8 mm	25,9 mm
	excl. teeth	24,5 mm	24,5 mm	25,0 mm	24,5 mm	25,4 mm	24,5 mm	25,9 mm	24,5 mm	26,3 mm	24,5 mm	26,8 mm	24,5 mm	27,2 mm	24,5 mm			
VBR – C 28 mm sterile	including teeth	28,0 mm	28,0 mm	28,5 mm	28,0 mm	28,9 mm	28,0 mm	29,4 mm	28,0 mm	29,8 mm	28,0 mm	30,3 mm	28,0 mm	30,7 mm	28,0 mm	Leander Trial 28mm	28,8 mm	27,9 mm
	excl. teeth	26,5 mm	26,5 mm	27,0 mm	26,5 mm	27,4 mm	26,5 mm	27,9 mm	26,5 mm	28,3 mm	26,5 mm	28,8 mm	26,5 mm	29,2 mm	26,5 mm			
VBR – C 30 mm sterile	including teeth	30,0 mm	30,0 mm	30,5 mm	30,0 mm	30,9 mm	30,0 mm	31,4 mm	30,0 mm	31,8 mm	30,0 mm	32,3 mm	30,0 mm	32,7 mm	30,0 mm	Leander Trial 30mm	30,8 mm	29,9 mm
	excl. teeth	28,5 mm	28,5 mm	29,0 mm	28,5 mm	29,4 mm	28,5 mm	29,9 mm	28,5 mm	30,3 mm	28,5 mm	30,8 mm	28,5 mm	31,2 mm	28,5 mm			



# LEANDER®-implant body STERILE

## Implants

Item no.	Description	Diameter	Height
1300010016-S	VBR – C 16 mm sterile	11.5 mm	16 mm
1300010018-S	VBR – C 18 mm sterile		18 mm
1300010020-S	VBR – C 20 mm sterile		20 mm
1300010022-S	VBR – C 22 mm sterile		22 mm
1300010024-S	VBR – C 24 mm sterile		24 mm
1300010026-S	VBR – C 26 mm sterile		26 mm
1300010028-S	VBR – C 28 mm sterile		28 mm
1300010030-S	VBR – C 30 mm sterile		30 mm

Item no.	Description	Diameter	Height
1300010032-S	VBR – C 32 mm sterile	11.5 mm	32 mm
1300010034-S	VBR – C 34 mm sterile		34 mm
1300010036-S	VBR – C 36 mm sterile		36 mm
1300010038-S	VBR – C 38 mm sterile		38 mm
1300010040-S	VBR – C 40 mm sterile		40 mm
1300010043-S	VBR – C 43 mm sterile		43 mm
1300010046-S	VBR – C 46 mm sterile		46 mm
1300010049-S	VBR – C 49 mm sterile		49 mm
1300010052-S	VBR – C 52 mm sterile		52 mm
1300010055-S	VBR – C 55 mm sterile		55 mm

optional  
optional  
optional  
optional  
optional  
optional  
optional  
optional  
optional  
optional  
optional



Implants

LEANDER®-end plates

STERILE





Item no.	Description	Length	Width	Angle	Figure
1300021200-S	Plate - C 12 x 14 x 0° sterile			0°	
1300021225-S	Plate - C 12 x 14 x 2,5° sterile	12 mm	14 mm	2,5°	
1300021250-S	Plate - C 12 x 14 x 5° sterile			5°	
1300021275-S	Plate - C 12 x 14 x 7,5° sterile			7,5°	
1300031400-S	Plate - C 14 x 16 x 0° sterile				
1300031425-S	Plate - C 14 x 16 x 2,5° sterile	14 mm	16 mm	2,5°	
1300031450-S	Plate - C 14 x 16 x 5° sterile			5°	
1300031475-S	Plate - C 14 x 16 x 7,5° sterile			7,5°	

LEANDER®-plate screw

STERILE

Item no.	Description	Diameter	Figure
1300010003-S	Plate Screw - C sterile	8.5 mm	

## LEANDER® instruments trial implants Body / measuring compass









Item no.	Description	Figure
1300040016	Leander Trial 16mm	
1300040018	Leander Trial 18mm	
1300040020	Leander Trial 20mm	
1300040022	Leander Trial 22mm	
1300040024	Leander Trial 24mm	
1300040026	Leander Trial 26mm	
1300040028	Leander Trial 28mm	
1300040030	Leander Trial 30mm	
1300040001	Measuring Compass	

optional



## Trial implant end plates

Item no.	Description	Figure
1300041214	Leander Plate Trial 12 x 14	
1300041416	Leander Plate Trial 14 x 16	

LEANDER® instruments

Item no.	Description	Figure	
1300040000	Leander Inserter		
1501010001B	Tristan Inserter B		
1501010011	Pin Driver		
1501010022	Distraction Pin 14mm		-single-use-
1501010023	Distraction Pin 16mm		-single-use-
1501010024	Distraction Pin 18mm		-single-use-
1501010022-S	Distraction Pin 14mm sterile		<b>STERILE</b> -single-use-
1501010023-S	Distraction Pin 16mm sterile		<b>STERILE</b> -single-use-
1501010024-S	Distraction Pin 18mm sterile		<b>STERILE</b> -single-use-

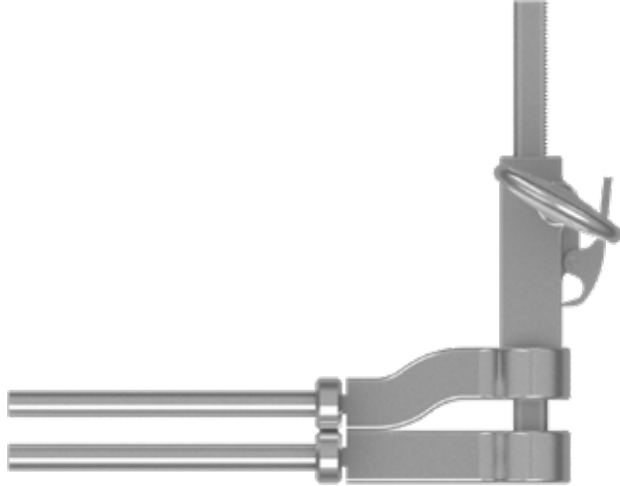
LEANDER® instruments

Item no.	Description	Figure
1501010010	Retrival body retractor	 <p>A surgical instrument consisting of a vertical threaded rod with a hand crank on the right side. Two parallel horizontal rods extend from the base of the vertical rod, held together by a bracket-like structure.</p>
2200010008	LP Setscrew Driver	 <p>A long, thin, cylindrical metal driver with a yellow band near the handle end.</p>
2000040231	Torque Driver 2.3	 <p>A torque driver with a black ergonomic handle, a silver-colored shaft, and a yellow-colored hexagonal head.</p>



LEANDER® tray

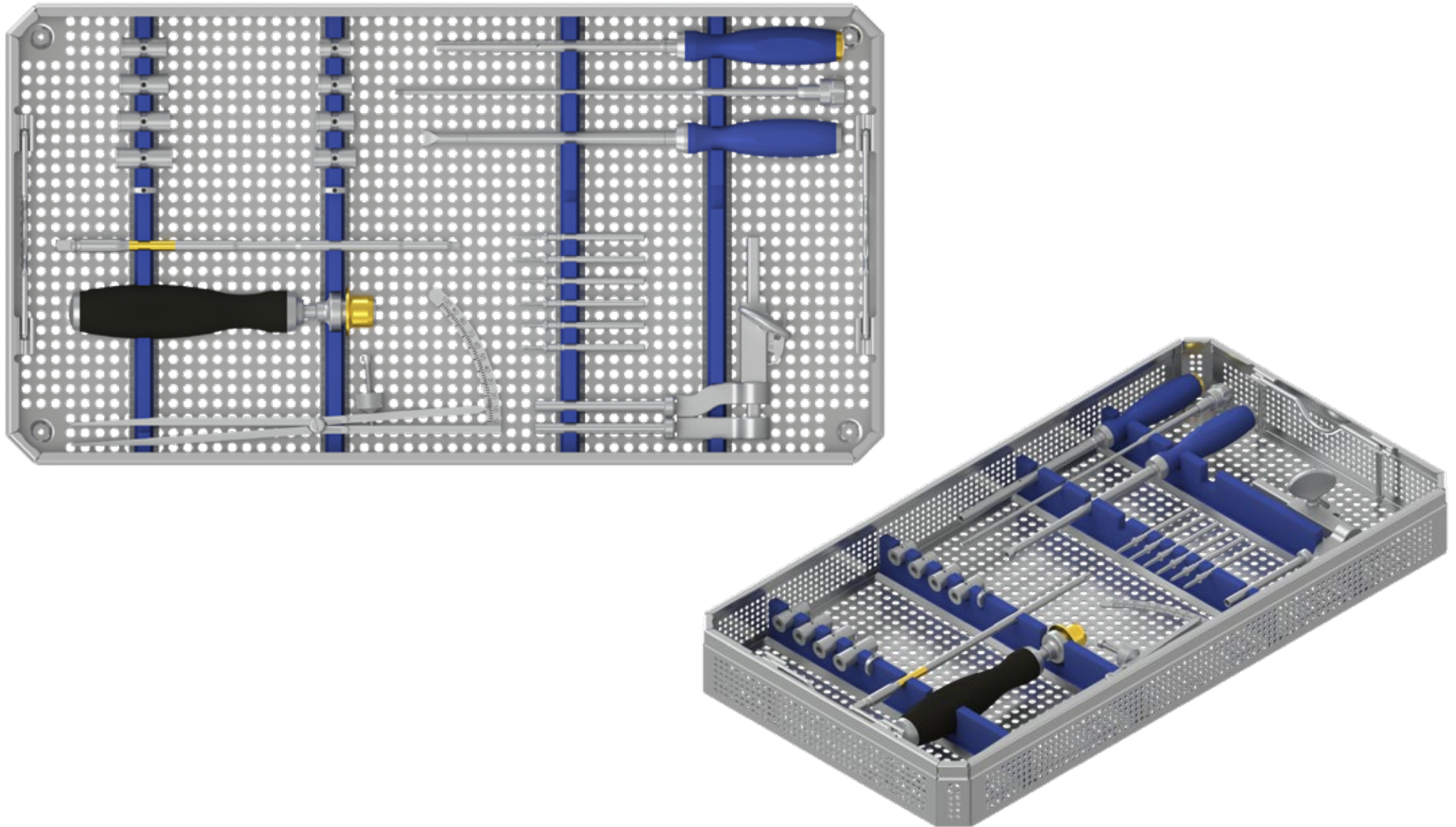

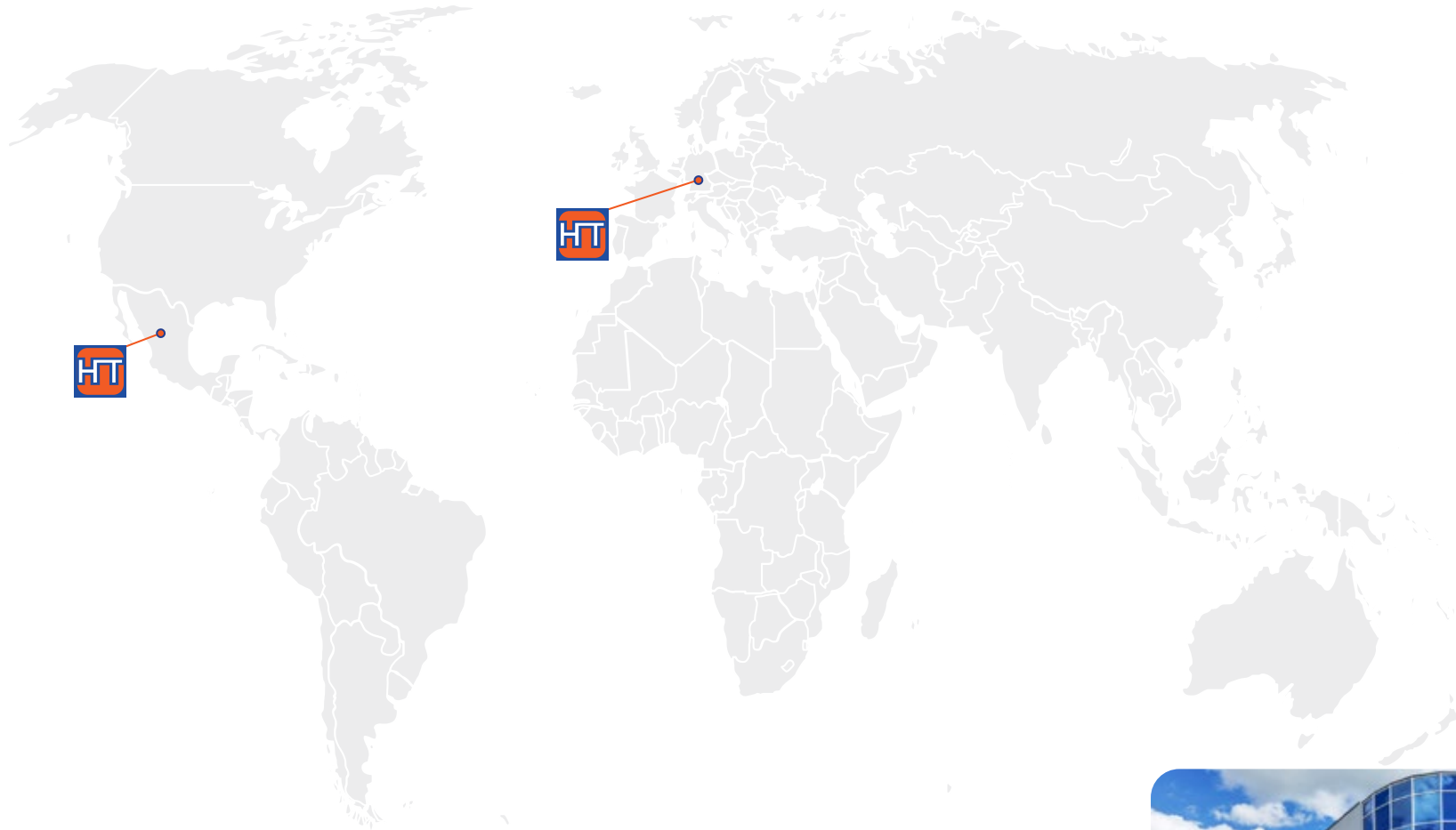

## Manufacturing and Sales

HumanTech Spine GmbH

Gewerbestr. 5  
D-71144 Steinenbronn

Germany

Phone: +49 (0) 7157 / 5246-71  
Fax: +49 (0) 7157 / 5246-66  
sales@humantech-spine.de  
www.humantech-spine.de

## Sales Latin America

HumanTech Mexico, S. DE R.L. DE C.V.

Rio Mixcoac No. 212-3  
Acacias del Valle  
Del. Benito Juárez  
C.P. 03240 Mexico, D.F.  
Mexico

Phone: +52 (0) 55/5534 5645  
Fax: +52 (0) 55/5534 4929  
info@humantech-solutions.mx  
www.humantech-spine.de



Follow us on:

