

VENUS[®] FIXATION

Spinal Fixation System



The VENUS® screw-rod fixation system was developed to stabilise the thoracic, lumbar and sacral spine. The extensive range of pedicle screws maximises the surgeon's intraoperative flexibility.

It may be used mono-segmentally as well as multi-segmentally. The system stands out due to its high degree of biomechanical stability. It features add-on modules such as long-head and augmentable screws, multiple threaded osteoporosis screws (6T screws), hooks, connectors and various types of rod with different degrees of rigidity and a set of minimally invasive tools. The possibility of a free combination of these modules and additional components, ensures a safe and stable construction in every situation.

Implants for primary fusion and revision procedures

The VENUS® spinal system is well suited for use in almost all indications requiring surgery and injuries to the thoracic and lumbar vertebrae, such as instability, degenerative disc disorders, degenerative spondylolisthesis, degenerative stenosis, deformities such as scoliosis and kyphosis, fractures and spondylitis as well as revision surgery.

The top-of-the-range, user-friendly VENUS® implant and instrument system meets every requirement when it comes to style, stability, handling, aesthetics and quality, and conforms to the highest international standards. With the specially developed thread design, the screws can be introduced very gently and are capable of withstanding maximum loading. The instruments are highly ergonomic, winning users over with their ease of use.

safe:

- Top loading system for ease of use

anatomical:

- Low profile
- Self-tapping thread design

transparent:

- Colour-coded screws
- Clearly arranged and simple instruments

stable:

- Immediate and lasting stability
- Tension-free installation due to polyaxial connection
- Load-optimised screw shaft design
- Increased hold in the pedicle thanks to multiple threads

flexible:

- Versatile application and techniques
- Large selection of implants
- Different spinal segments
- Optimum adaptability to patient anatomy
- Can be combined with all VENUS® implants



VENUS[®]

Spinal Fixation System

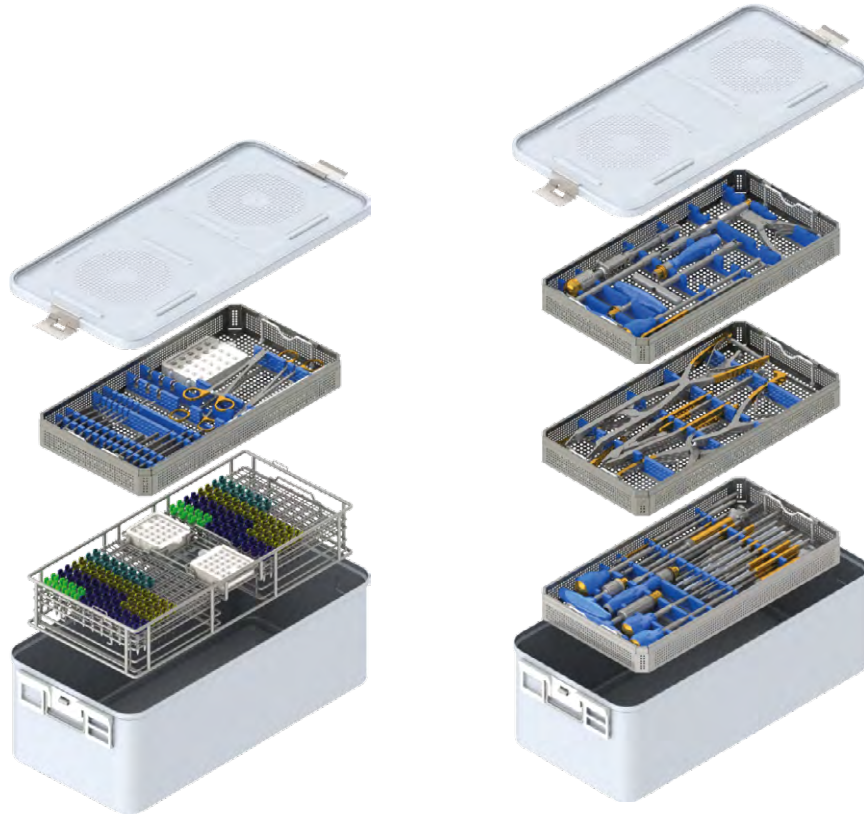

Product-specific advantages

- safe
- anatomical
- transparent
- stable
- flexible

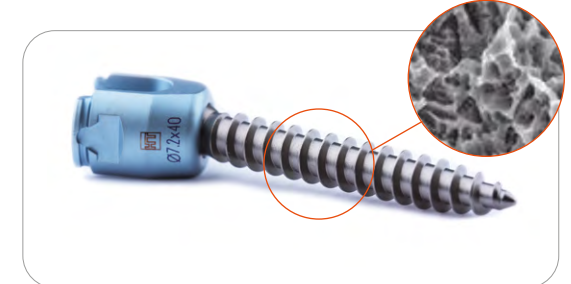
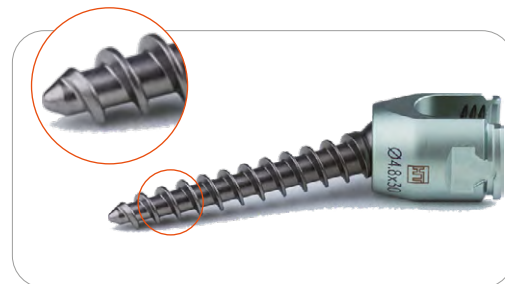

Pedicle screws

Standard pedicle screws

The unique, self-tapping thread design removes the need for separate cutting outlines. The screw head contains a macrostructure, which lends the system great biomechanical stability. The variety of screws means that all types of bone can be treated.

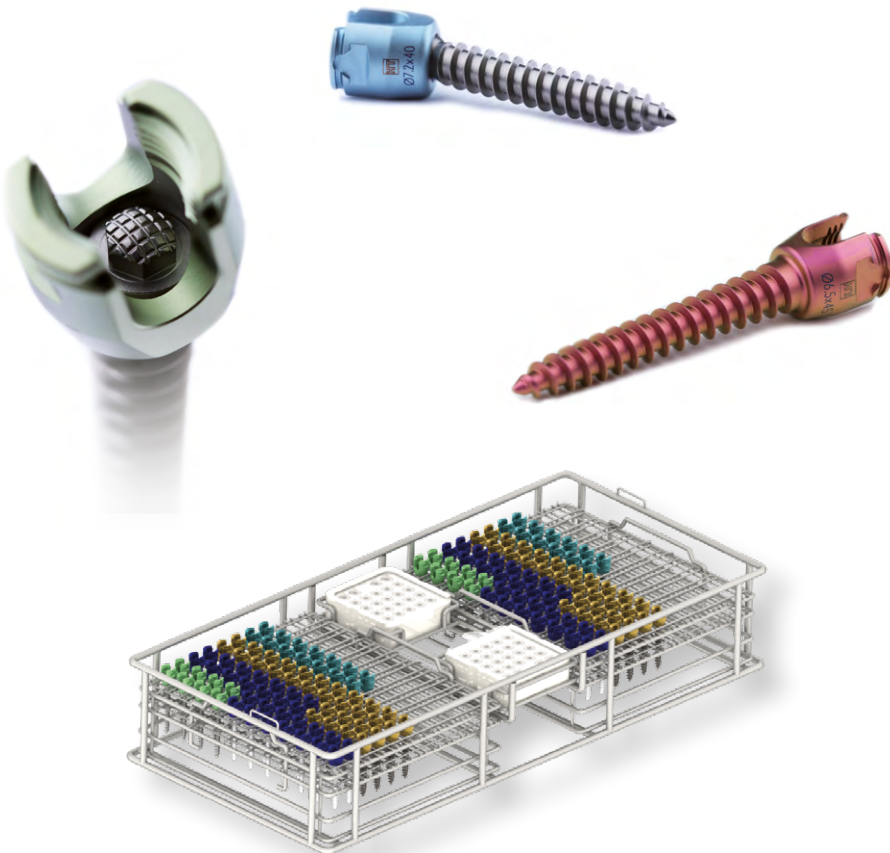

6T Pedicle screws

The main feature of 6T pedicle screws is the thread design of the screw shaft. The thread is divided into a cancellous thread on the lower section and a cortical thread on the upper section of the screw shaft. The two deeper threads on the lower section give a better hold in cancellous bone. The cortical thread is designed as a four-ridge thread to improve the primary stability in the cortical bones and in the pedicle area.

The increased central diameter in the four-ridge thread section prevents postoperative loosening through ongoing physical pressure on the screw. The forces in this area are distributed across a greater circumference.

Conical thread sections allow easy insertion with increased primary stability.

The surfaces at the implant thread are treated in a special procedure. This leads to improved ingrowth behaviour of the bone on the screw and to a shortening of osseointegration time.

The 6T pedicle screws are available for individual use and come in four different designs:

- Polyaxial screw
- Polyaxial screw, augmentable
- Long headed screws
- Revision screws with a large diameter

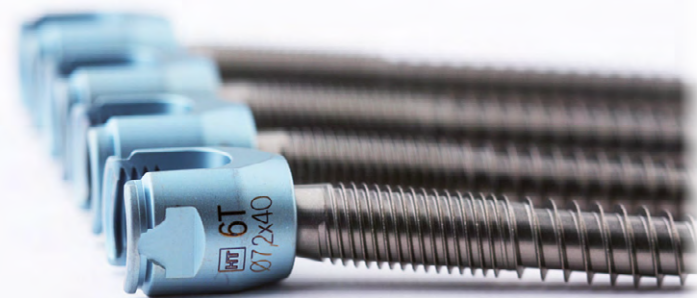

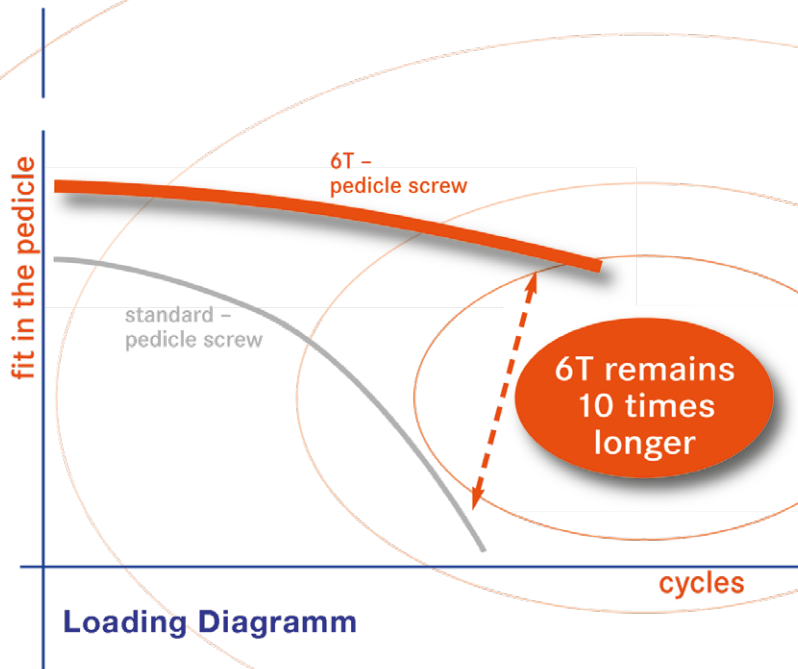

The 6T pedicle screws can be used with both VENUS Standard Instruments and in a minimally invasive way with VENUS@mini. A firm hold is preferred in osteoporotic bones and this is noticeable from the moment each screw is screwed in. The advanced thread profile offers the following advantages over standard systems:

- Protects against screws loosening with physical pressure
- Increased screw-in speed
- Optimal hold in osteoporotic bones

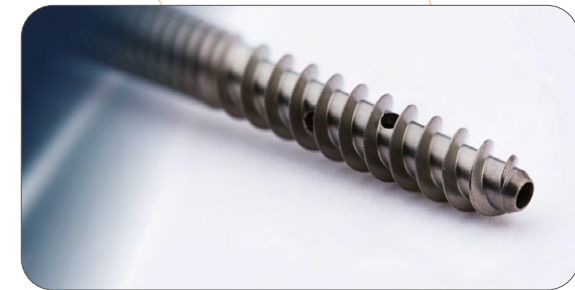

Cortical thread

Four-ridge fine thread for improved primary stability in the cortical bone and pedicle



Cancellous thread

Two-ridge thread for improved hold in cancellous bone

Implant rods

Straight and curved rods in varying lengths, shapes and materials reduce the effort involved in bending and cutting the rods to length during the OP to a minimum.

Nitinol phantom rods and special alignment markers on the rods enable the rod to undergo optimum preparation before being inserted into the construction. For particular correctional procedures, the VENUS® system also offers rods with a hexagonal end on request.

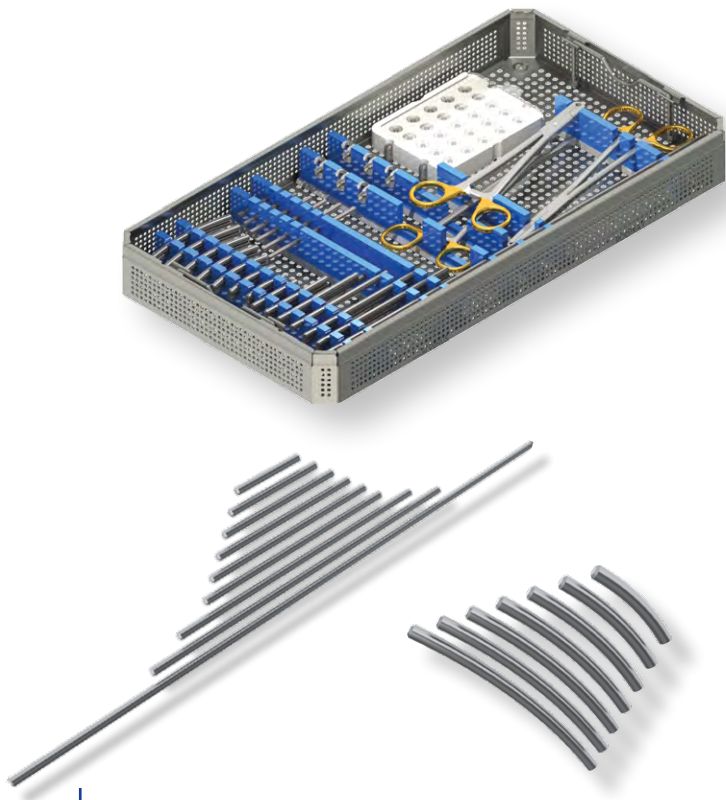

Reliability in use

The VENUS® instrument set is among the most outstanding surgical instrument systems. The system is the exclusive product of “Made in Germany” engineering skill in line with ISO and EC specifications.

Highly-qualified quality management, accurate testing methods and complete traceability ensure the highest production standard, something that our customers can always rely on.

Quality and precision are our incentive for developing new, ground-breaking and more effective ways of improving the VENUS® instrument system. Close contact with users is critical for our developments in this process.

The efficient, modular and clearly arranged instrument set makes the VENUS® spinal system a universal system. It allows the operator to insert an implant quickly and safely and to secure the relevant segments for a primary stability dorsal instrument.

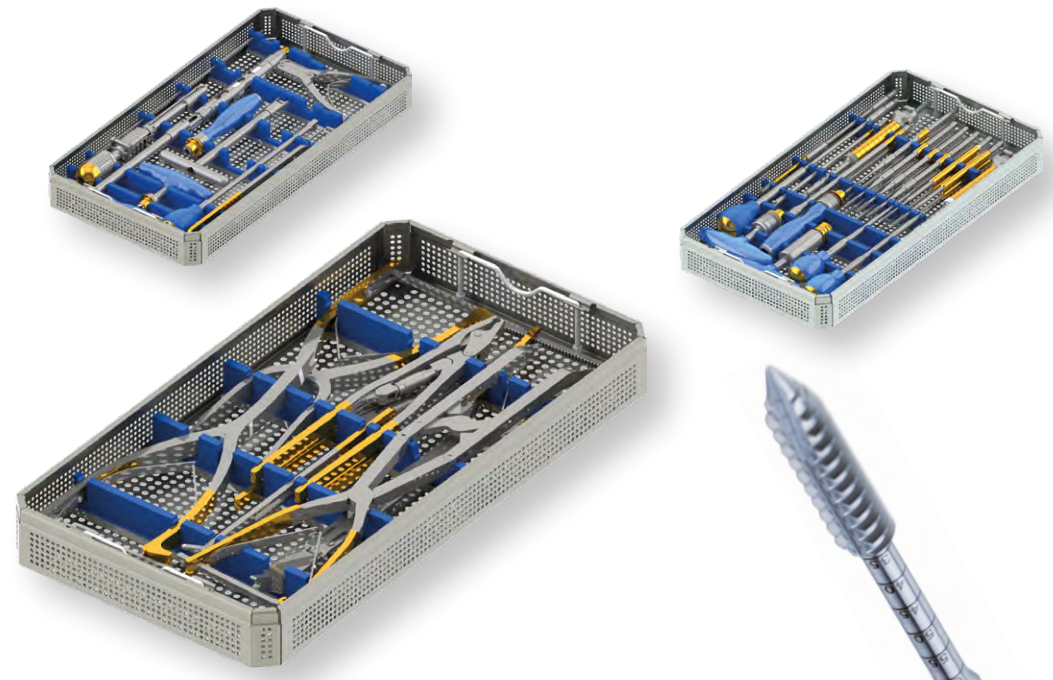



Preparing the pedicle

Set the pedicle insertion point. Open the pedicle canal using the Awl.

Note:

The Awl is available with and without stop and also in cannulated form. The variants of the Awl without stop should be used only for the initial preparation of the pedicle. The deeper the preparation is carried out, the larger the core hole will be at the entry point.



Awling and probing

The pedicle canal is awled. Using light pressure, the Pedicle Probe is advanced into the pedicle canal carefully in half rotations.

Note:

There are two types of Pedicle Probe available: straight and curved.



Tapping

All pedicle screws are self-tapping. However, we recommend using taps in cases where the bone structure is very strong. These are available for all screw diameters.

Note:

For 6T screws we offer special taps to prepare cancellous and cortical thread. We always recommend using the tap that corresponds to the diameter of the pedicle screw.



VENUS®

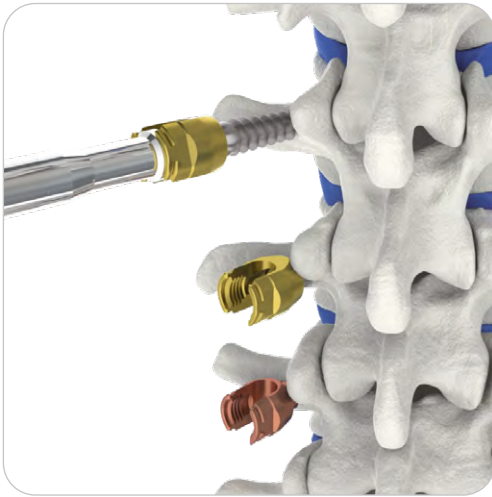

Inserting the pedicle screws I

Monoaxial screw:

The tip of the Monoaxial Screw Driver clicks into the screw head and secures the screw. The screw is screwed into the pedicle canal.

Polyaxial screw:

First, insert the screwdriver tip (inner shaft) into the screw head and attach it to the outer hexagon of the thread shaft. Then connect the outer guide to the screw head by screwing it into the inner thread of the screw head.

When using the Polyaxial Screw Driver, you must push the locking adapter forward and lock it into the connection geometry. You must also check the button of the locking adapter. (See user

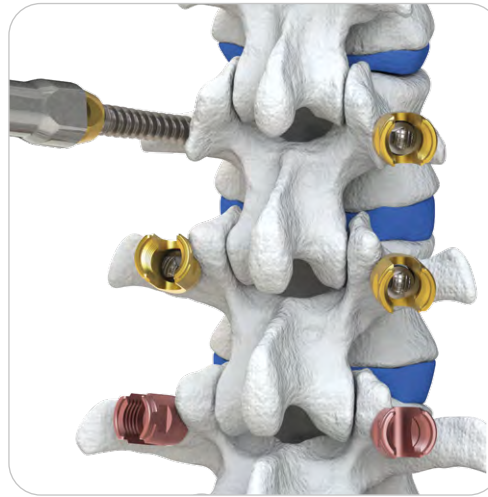

Inserting the pedicle screws II

information of the Polyaxial Screw Driver.)

When using the Polyaxial Screw Inserter, secure the pedicle screw and then feed the guide wire over the screw head. The screw is screwed into the pedicle canal.

Note:

If desired, use the Reposition Screw Driver afterwards to correct the depth of engagement.



Fixing the rod

Set the rod length. A Phantom Rod is contained in the instruments to make it easier to set the rod length.

Widen the Rod Cutter so that the rod holders stay open. Depending on the relative diameter, slide the rod through the appropriate holder. With short, sharp pressure, shorten the rod to the intended point.

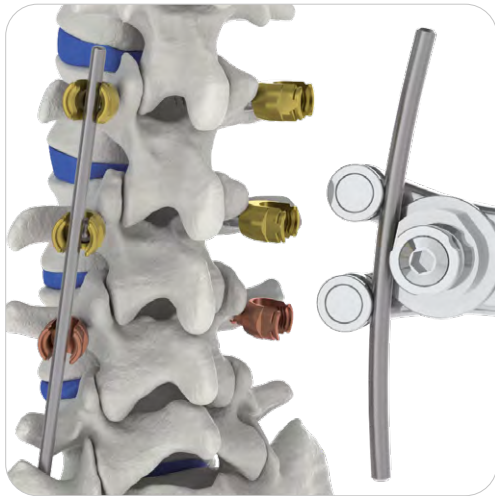

Adjust and insert the rod

Insert the rod into the screw heads using the Rod Inserter and, if need be, with the help of your fingertips. The rod profile undergoes fine tuning and the rod is bent to the corresponding radius. If necessary, place the rod using an Rod Pusher or a Rocker to ensure the correct positioning in the screw head.



Using the Rocker

Position the Rocker on the screw head by inserting the fork ends into the lateral grooves of the screw head. Crank the rocker shaft until it is sitting on the rod. Then continue to crank it carefully, making visual and, if need be, x-ray checks until the rod and the screw head are interlocked. Insert the set screws and fix the rod in the screw head.

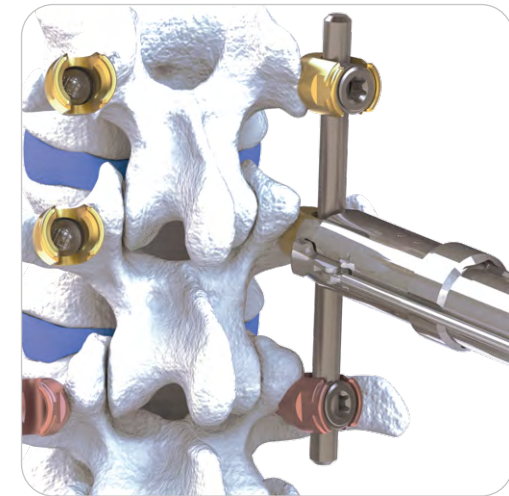

Using the Approximator

Attach the instrument to the screw head. The instrument is driven over the implant head until distinct resistance is noticeable. Lock the instrument onto the implant by tilting the locking lever in the direction of the handle cage. Carefully turn the handle clockwise. Reposition the segment making visual and, if necessary, X-ray checks. Insert the set screws and fix the rod in the screw head.

Note:

The Approximator and the screw head must be connected gently and without force. If in doubt, remove the Approximator and reposition it. Make sure when using the Approximator that the implant rod has to protrude at least 5mm on both sides over the screw head so that the repositioning yoke has full contact with the rod.

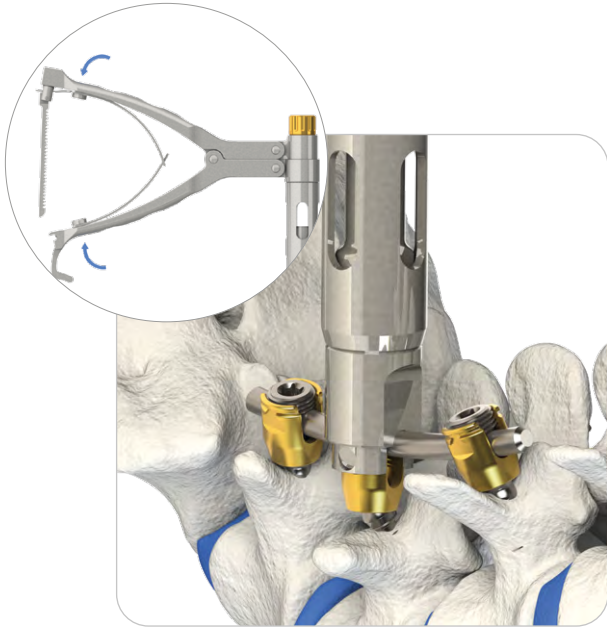

Using the Persuader

If required, the Persuader Forceps Style can also be used to reposition the moved spine or to position the rod in the screw head.

The instrument is driven over the implant head until distinct resistance is noticeable. Press the handle to lock the instrument onto the implant. Connection is guaranteed as soon as the first tooth of the toothed rod is locked onto the anterior handle. Pressing the handle further repositions the spine and positions the rod into the screw head rod holder. The position is maintained by the toothed rod.



Fixing the rod

Once the rod is correctly positioned in the screw head, fix the rod in the screw head with the set screw using the Set Screw Insertor. To prevent cross-threading while screwing in the set screw, first screw in a counter-clockwise direction until you clearly feel the thread “click into” the screw head. Then continue to screw in the set screw.

Caution!

Be sure to only screw in the set screw loosely; the final torque is applied using the Set Screw Driver.

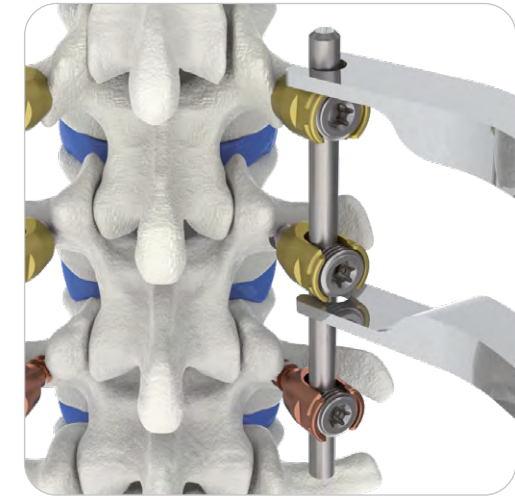

Compression / Distraction

Position the Compressor or Distractor on the screw heads and carry out the compression or distraction procedure until the desired position has been achieved. To ensure the compression or distraction result, tighten with the Set Screw Driver.

Note:

The set screws must not be fully tightened during this manoeuvre. If need be, loosen the set screws carefully using the Set Screw Driver.

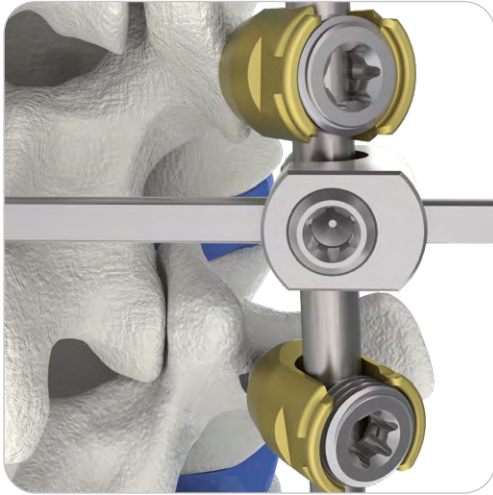

Transverse Connector

Attach a Transverse Connector Hook with the help of the Transverse Connector Inserter. Connect the second hook with the Transverse Connector Rod which is inserted via the Transverse Connector Rod Holder and attach it to the second rod of the construction. Align the elements and connect the Transverse Connector Hooks using the Transverse Connector Rod.

Screw the set screws all the way into the Transverse Connector Hook using the Set Screw Driver.

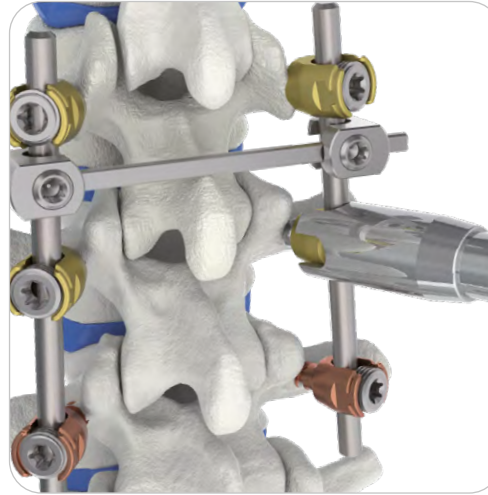

Final tightening

The Counter Holder is guided over the screw head and pushed all the way onto the rod. Ensure that the notches at the distal end of the Counter Holder take up the inserted rod. Couple the Set Screw Driver and the Torque Driver. Place the combined instruments through the fitted Counter Holder. Tighten the set screw in a clockwise direction. Follow the same approach for all other set screws.

Note:

The full torque of 12 Nm is reached when you hear a clicking sound in the Torque Driver.

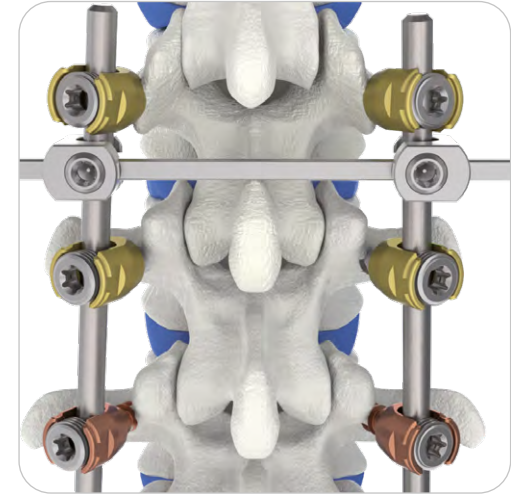

Final construction

Final check on the construction with X-ray control images taken in two planes. Cleaning of the surgical area and closure of the wound.

Monoaxial Screws

Item no.	Description	Diameter	Length	
VL-PMS	Polyaxial / Monoaxial Set Screw			
VL-MS-5-4830	Monoaxial Screw	4.8 mm	30 mm	Ø 4.8
VL-MS-5-4835	Monoaxial Screw	4.8 mm	35 mm	
VL-MS-5-4840	Monoaxial Screw	4.8 mm	40 mm	
VL-MS-5-4845	Monoaxial Screw	4.8 mm	45 mm	
VL-MS-5-5525	Monoaxial Screw	5.5 mm	25 mm	
VL-MS-5-5530	Monoaxial Screw	5.5 mm	30 mm	
VL-MS-5-5535	Monoaxial Screw	5.5 mm	35 mm	
VL-MS-5-5540	Monoaxial Screw	5.5 mm	40 mm	
VL-MS-5-5545	Monoaxial Screw	5.5 mm	45 mm	
VL-MS-5-5550	Monoaxial Screw	5.5 mm	50 mm	
VL-MS-5-5555	Monoaxial Screw	5.5 mm	55 mm	Ø 6.5
VL-MS-5-6535	Monoaxial Screw	6.5 mm	35 mm	
VL-MS-5-6540	Monoaxial Screw	6.5 mm	40 mm	
VL-MS-5-6545	Monoaxial Screw	6.5 mm	45 mm	
VL-MS-5-6550	Monoaxial Screw	6.5 mm	50 mm	
VL-MS-5-6555	Monoaxial Screw	6.5 mm	55 mm	Ø 7.2
VL-MS-5-7240	Monoaxial Screw	7.2 mm	40 mm	
VL-MS-5-7245	Monoaxial Screw	7.2 mm	45 mm	
VL-MS-5-7250	Monoaxial Screw	7.2 mm	50 mm	
VL-MS-5-7255	Monoaxial Screw	7.2 mm	55 mm	
VL-MS-5-7260	Monoaxial Screw	7.2 mm	60 mm	

Set Screw



Polyaxial Screws

Item no.	Description	Diameter	Length	
VL-PS-5-4825	Polyaxial Screw	4.8 mm	25 mm	Ø 4.8
VL-PS-5-4830	Polyaxial Screw	4.8 mm	30 mm	
VL-PS-5-4835	Polyaxial Screw	4.8 mm	35 mm	
VL-PS-5-4840	Polyaxial Screw	4.8 mm	40 mm	
VL-PS-5-4845	Polyaxial Screw	4.8 mm	45 mm	
VL-PS-5-5525	Polyaxial Screw	5.5 mm	25 mm	Ø 5.5
VL-PS-5-5530	Polyaxial Screw	5.5 mm	30 mm	
VL-PS-5-5535	Polyaxial Screw	5.5 mm	35 mm	
VL-PS-5-5540	Polyaxial Screw	5.5 mm	40 mm	
VL-PS-5-5545	Polyaxial Screw	5.5 mm	45 mm	
VL-PS-5-5550	Polyaxial Screw	5.5 mm	50 mm	
VL-PS-5-5555	Polyaxial Screw	5.5 mm	55 mm	Ø 6.5
VL-PS-5-6525	Polyaxial Screw	6.5 mm	25 mm	
VL-PS-5-6530	Polyaxial Screw	6.5 mm	30 mm	
VL-PS-5-6535	Polyaxial Screw	6.5 mm	35 mm	
VL-PS-5-6540	Polyaxial Screw	6.5 mm	40 mm	
VL-PS-5-6545	Polyaxial Screw	6.5 mm	45 mm	
VL-PS-5-6550	Polyaxial Screw	6.5 mm	50 mm	
VL-PS-5-6555	Polyaxial Screw	6.5 mm	55 mm	Ø 7.2
VL-PS-5-7235	Polyaxial Screw	7.2 mm	35 mm	
VL-PS-5-7240	Polyaxial Screw	7.2 mm	40 mm	
VL-PS-5-7245	Polyaxial Screw	7.2 mm	45 mm	
VL-PS-5-7250	Polyaxial Screw	7.2 mm	50 mm	
VL-PS-5-7255	Polyaxial Screw	7.2 mm	55 mm	
VL-PS-5-7260	Polyaxial Screw	7.2 mm	60 mm	



Cannulated Screws

Item no.	Name	
1008044825	Cannulated Screw Ø 4.8 x 25 mm	Ø 4.8
1008044830	Cannulated Screw Ø 4.8 x 30 mm	
1008044835	Cannulated Screw Ø 4.8 x 35 mm	
1008044840	Cannulated Screw Ø 4.8 x 40 mm	
1008044845	Cannulated Screw Ø 4.8 x 45 mm	
1008045525	Cannulated Screw Ø 5.5 x 25 mm	Ø 5.5
1008045530	Cannulated Screw Ø 5.5 x 30 mm	
1008045535	Cannulated Screw Ø 5.5 x 35 mm	
1008045540	Cannulated Screw Ø 5.5 x 40 mm	
1008045545	Cannulated Screw Ø 5.5 x 45 mm	
1008045550	Cannulated Screw Ø 5.5 x 50 mm	Ø 6.5
1008045555	Cannulated Screw Ø 5.5 x 55 mm	
1008046525	Cannulated Screw Ø 6.5 x 25 mm	
1008046530	Cannulated Screw Ø 6.5 x 30 mm	
1008046535	Cannulated Screw Ø 6.5 x 35 mm	
1008046540	Cannulated Screw Ø 6.5 x 40 mm	Ø 7.2
1008046545	Cannulated Screw Ø 6.5 x 45 mm	
1008046550	Cannulated Screw Ø 6.5 x 50 mm	
1008046555	Cannulated Screw Ø 6.5 x 55 mm	
1008047235	Cannulated Screw Ø 7.2 x 35 mm	
1008047240	Cannulated Screw Ø 7.2 x 40 mm	Ø 7.2
1008047245	Cannulated Screw Ø 7.2 x 45 mm	
1008047250	Cannulated Screw Ø 7.2 x 50 mm	
1008047255	Cannulated Screw Ø 7.2 x 55 mm	
1008047260	Cannulated Screw Ø 7.2 x 60 mm	



Augmentable Screws

Item no.	Name	
1006105540	Fenestrated Screw Ø 5.5 x 40 mm	Ø 5.5
1006105545	Fenestrated Screw Ø 5.5 x 45 mm	
1006105550	Fenestrated Screw Ø 5.5 x 50 mm	
1006105555	Fenestrated Screw Ø 5.5 x 55 mm	Ø 6.5
1006106540	Fenestrated Screw Ø 6.5 x 40 mm	
1006106545	Fenestrated Screw Ø 6.5 x 45 mm	
1006106550	Fenestrated Screw Ø 6.5 x 50 mm	Ø 7.2
1006106555	Fenestrated Screw Ø 6.5 x 55 mm	
1006107240	Fenestrated Screw Ø 7.2 x 40 mm	
1006107245	Fenestrated Screw Ø 7.2 x 45 mm	Ø 7.2
1006107250	Fenestrated Screw Ø 7.2 x 50 mm	
1006107255	Fenestrated Screw Ø 7.2 x 55 mm	



Multiple Threaded Osteoporosis Screws (6T Screw)

Item no.	Description	
VL-PS2-5-4825	Polyaxial Screw 6T 4.8 x 25 mm	Ø 4.8
VL-PS2-5-4830	Polyaxial Screw 6T 4.8 x 30 mm	
VL-PS2-5-4835	Polyaxial Screw 6T 4.8 x 35 mm	
VL-PS2-5-4840	Polyaxial Screw 6T 4.8 x 40 mm	
VL-PS2-5-5525	Polyaxial Screw 6T 5.5 x 25 mm	Ø 5.5
VL-PS2-5-5530	Polyaxial Screw 6T 5.5 x 30 mm	
VL-PS2-5-5535	Polyaxial Screw 6T 5.5 x 35 mm	
VL-PS2-5-5540	Polyaxial Screw 6T 5.5 x 40 mm	
VL-PS2-5-5545	Polyaxial Screw 6T 5.5 x 45 mm	
VL-PS2-5-5550	Polyaxial Screw 6T 5.5 x 50 mm	
VL-PS2-5-5555	Polyaxial Screw 6T 5.5 x 55 mm	Ø 6.5
VL-PS2-5-6525	Polyaxial Screw 6T 6.5 x 25 mm	
VL-PS2-5-6530	Polyaxial Screw 6T 6.5 x 30 mm	
VL-PS2-5-6535	Polyaxial Screw 6T 6.5 x 35 mm	
VL-PS2-5-6540	Polyaxial Screw 6T 6.5 x 40 mm	
VL-PS2-5-6545	Polyaxial Screw 6T 6.5 x 45 mm	
VL-PS2-5-6550	Polyaxial Screw 6T 6.5 x 50 mm	Ø 7.2
VL-PS2-5-6555	Polyaxial Screw 6T 6.5 x 55 mm	
VL-PS2-5-7240	Polyaxial Screw 6T 7.2 x 40 mm	
VL-PS2-5-7245	Polyaxial Screw 6T 7,2 x 45 mm	
VL-PS2-5-7250	Polyaxial Screw 6T 7.2 x 50 mm	
VL-PS2-5-7255	Polyaxial Screw 6T 7.2 x 55 mm	
VL-PS2-5-7260	Polyaxial Screw 6T 7.2 x 60 mm	



Augmentable 6T Screws

Item no.	Name	
1010045540	Fenestrated 6T Screw Ø 5.5 x 40 mm	Ø 5.5
1010045545	Fenestrated 6T Screw Ø 5.5 x 45 mm	
1010045550	Fenestrated 6T Screw Ø 5.5 x 50 mm	
1010045555	Fenestrated 6T Screw Ø 5.5 x 55 mm	Ø 6.5
1010046540	Fenestrated 6T Screw Ø 6.5 x 40 mm	
1010046545	Fenestrated 6T Screw Ø 6.5 x 45 mm	
1010046550	Fenestrated 6T Screw Ø 6.5 x 50 mm	
1010046555	Fenestrated 6T Screw Ø 6.5 x 55 mm	Ø 7.2
1010047240	Fenestrated 6T Screw Ø 7.2 x 40 mm	
1010047245	Fenestrated 6T Screw Ø 7.2 x 45 mm	
1010047250	Fenestrated 6T Screw Ø 7.2 x 50 mm	
1010047255	Fenestrated 6T Screw Ø 7.2 x 55 mm	
1010047260	Fenestrated 6T Screw Ø 7.2 x 60 mm	

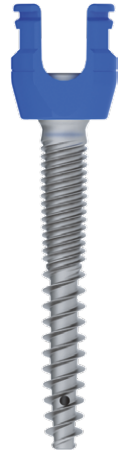

Revision Screws 6T

Item no.	Description	
1006098535	Cannulated Revision Screw 6T Ø 8.5 mm x 35 mm	Ø 8.5
1006098540	Cannulated Revision Screw 6T Ø 8.5 mm x 40 mm	
1006098545	Cannulated Revision Screw 6T Ø 8.5 mm x 45 mm	
1006098550	Cannulated Revision Screw 6T Ø 8.5 mm x 50 mm	
1006098555	Cannulated Revision Screw 6T Ø 8.5 mm x 55 mm	
1006098560	Cannulated Revision Screw 6T Ø 8.5 mm x 60 mm	



Implants

Double Threaded Cannulated Screws (2T Cannulated Screw)

Item no.	Name	
4000014825	2T Cannulated Screw 0 4.8 x 25mm	Ø 4.8
4000014830	2T Cannulated Screw 0 4 8 x 30mm	
4000014835	2T Cannulated Screw 0 4.8 x 35mm	
4000014840	2T Cannulated Screw 0 4 8 x 40mm	
4000014845	2T Cannulated Screw 0 4.8 x 45mm	
4000015525	2T Cannulated Screw 0 5.5 x 25mm	Ø 5.5
4000015530	2T Cannulated Screw 0 5.5 x 30mm	
4000015535	2T Cannulated Screw 0 5.5 x 35mm	
4000015540	2T Cannulated Screw 0 5.5 x 40mm	
4000015545	2T Cannulated Screw 0 5.5 x 45mm	
4000015550	2T Cannulated Screw 0 5.5 x 50mm	Ø 5.5
4000015555	2T Cannulated Screw 0 5 5 x 55mm	
4000016525	2T Cannulated Screw 0 6.5 x 25mm	
4000016530	2T Cannulated Screw 0 6.5 x 30mm	
4000016535	2T Cannulated Screw 0 6.5 x 35mm	
4000016540	2T Cannulated Screw 0 6.5 x 40mm	Ø 6.5
4000016545	2T Cannulated Screw 0 6.5 x 45mm	
4000016550	2T Cannulated Screw 0 6.5 x 50mm	
4000016555	2T Cannulated Screw 0 6.5 x 55mm	
4000017235	2T Cannulated Screw 0 7.2 x 35mm	
4000017240	2T Cannulated Screw 0 7.2 x 40mm	
4000017245	2T Cannulated Screw 0 7.2 x 45mm	
4000017250	2T Cannulated Screw 0 7 2 x 50mm	
4000017255	2T Cannulated Screw 0 7 2 x 55mm	
4000017260	2T Cannulated Screw 0 7,2 x 60mm	



Double Threaded Polyaxial Screws (2T Screw)

Item no.	Description	
4000024825	2T Polyaxial Screw 04 Bx25mm	Ø 4.8
4000024830	2T Polyaxial Screw 04 8x30mm	
4000024835	2T Polyaxial Screw 04 8x35mm	
4000024840	2T Polyaxial Screw 04 8x40mm	
4000024845	2T Polyaxial Screw 04 8x45mm	
4000025525	2T Polyaxial Screw 05.5x25mm	Ø 5.5
4000025530	2T Polyaxial Screw 05 5x30mm	
4000025535	2T Polyaxial Screw 05 5x35mm	
4000025540	2T Polyaxial Screw 05.5x4Qmm	
4000025545	2T Polyaxial Screw 05.5x45mm	
4000025550	2T Polyaxial Screw 05 5x50m m	Ø 5.5
4000025555	2T Polyaxial Screw 05 5x55mm	
4000026525	2T Polyaxial Screw 06.5x25mm	
4000026530	2T Polyaxial Screw 06 5x30mm	
4000026535	2T Polyaxial Screw 06 5x35mm	
4000026540	2T Polyaxial Screw 06 5x40mm	Ø 6.5
4000026545	2T Polyaxial Screw 06.5x45mm	
4000026550	2T Polyaxial Screw 06 5x50mm	
4000026555	2T Polyaxial Screw 06 5x55mm	
4000027235	2T Polyaxial Screw 07 2x35mm	
4000027240	2T Polyaxial Screw 07.2x40mm	
4000027245	2T Polyaxial Screw 07.2x45mm	
4000027250	2T Polyaxial Screw 07 2x50mm	
4000027255	2T Polyaxial Screw 07.2x55mm	
4000027260	2T Polvaxial Screw 07 2x60mm	



Double Threaded Fenestrated Screws (2T Screw)

Item no.	Description	
4000045540	2T Fenestrated Screw 05 5x40mm	Ø 5.5
4000045545	2T Fenestrated Screw 05.5x45mm	
4000045550	2T Fenestrated Screw 05.5x50mm	
4000045555	2T Fenestrated Screw 05 5x55mm	Ø 6.5
4000046540	2T Fenestrated Screw 06 5x40mm	
4000046545	2T Fenestrated Screw 06 5x45mm	
4000046550	2T Fenestrated Screw 06.5x50mm	Ø 7.2
4000046555	2T Fenestrated Screw 06.5x55mm	
4000047240	2T Fenestrated Screw 07.2x40mm	
4000047245	2T Fenestrated Screw 07 2x45mm	Ø 7.2
4000047250	2T Fenestrated Screw 07 2x50mm	
4000047255	2T Fenestrated Screw 07.2x55mm	
4000047260	2T Fenestrated Screw 07 2x60mm	



Curved Rods

Item no.	Description	Diameter	Length
VL-RC-5-4	Rod, curved	5.5 mm	40 mm
VL-RC-5-5	Rod, curved	5.5 mm	50 mm
VL-RC-5-6	Rod, curved	5.5 mm	60 mm
VL-RC-5-7	Rod, curved	5.5 mm	70 mm
VL-RC-5-8	Rod, curved	5.5 mm	80 mm
VL-RC-5-9	Rod, curved	5.5 mm	90 mm
VL-RC-5-10	Rod, curved	5.5 mm	100 mm
VL-RC-5-15	Rod, curved	5.5 mm	150 mm
VL-RC-5-20	Rod, curved	5.5 mm	200 mm
VL-RC-5-25	Rod, curved	5.5 mm	250 mm



Straight Rods

Item no.	Description	Diameter	Length																																							
VL-RS-5-4	Rod, straight	5.5 mm	40 mm																																							
VL-RS-5-5	Rod, straight	5.5 mm	50 mm																																							
VL-RS-5-7	Rod, straight	5.5 mm	70 mm																																							
VL-RS-5-9	Rod, straight	5.5 mm <td 90 mm	VL-RS-5-10	Rod, straight	5.5 mm	100 mm	VL-RS-5-11	Rod, straight	5.5 mm	110 mm	VL-RS-5-13	Rod, straight	5.5 mm	130 mm	VL-RS-5-15	Rod, straight	5.5 mm	150 mm	VL-RS-5-20	Rod, straight	5.5 mm	200 mm	VL-RS-5-25	Rod, straight	5.5 mm	250 mm	VL-RS-5-30	Rod, straight	5.5 mm	300 mm	VL-RS-5-35	Rod, straight	5.5 mm	350 mm	VL-RS-5-40	Rod, straight	5.5 mm	400 mm	VL-RS-5-45	Rod, straight	5.5 mm	450 mm
VL-RS-5-10	Rod, straight	5.5 mm	100 mm																																							
VL-RS-5-11	Rod, straight	5.5 mm	110 mm																																							
VL-RS-5-13	Rod, straight	5.5 mm	130 mm																																							
VL-RS-5-15	Rod, straight	5.5 mm	150 mm																																							
VL-RS-5-20	Rod, straight	5.5 mm	200 mm																																							
VL-RS-5-25	Rod, straight	5.5 mm	250 mm																																							
VL-RS-5-30	Rod, straight	5.5 mm	300 mm																																							
VL-RS-5-35	Rod, straight	5.5 mm	350 mm																																							
VL-RS-5-40	Rod, straight	5.5 mm	400 mm																																							
VL-RS-5-45	Rod, straight	5.5 mm	450 mm																																							



Transverse Connector

Item no.	Description	Length
1001050500	Transverse Connector Hook	
VL-TR-50	Transverse Connector Rod	50 mm
VL-TR-60	Transverse Connector Rod	60 mm
VL-TR-70	Transverse Connector Rod	70 mm
VL-TR-80	Transverse Connector Rod	80 mm
VL-TR-90	Transverse Connector Rod	90 mm
VL-TR-100	Transverse Connector Rod	100 mm



Item no.	Description
055068	Awl
1001010079	Cannulated Awl 30
1001010047	Awl without stop
1106011101	Cannulated Awl without stop
1101010006	Goniometer Awl
055217	Pedicle Probe
055271	Pedicle Probe Curved
055067	Pedicle Sounder
1001010059	Pedicle Sounder fine



Taps

Item no.	Description
055054 055051 055052 055053	Taps Tap Ø 4.8 mm Tap Ø 5.5 mm Tap Ø 6.5 mm Tap Ø 7.2 mm
1006011203 1006011200 1006011201 1006011202	Cannulated Taps Cannulated Tap 4.8 Cannulated Tap 5.5 Cannulated Tap 6.5 Cannulated Tap 7.2
1010030003 1010030000 1010030001 1010030002	Taps 6T 6T Tap 4.8 6T Tap 5.5 6T Tap 6.5 6T Tap 7.2
1010030015 1010030012 1010030013 1010030014 1010030010	Cannulated Taps 6T Cannulated 6T Tap 4.8 Cannulated 6T Tap 5.5 Cannulated 6T Tap 6.5 Cannulated 6T Tap 7.2 Cannulated 6T Tap 8.5
1010030008 1010030005 1010030006 1010030007	Taps 6T Fine Thread 6T Tap 4.8 4T 6T Tap 5.5 4T 6T Tap 6.5 4T 6T Tap 7.2 4T
1010030019 1010030016 1010030017 1010030018 1010030011	Cannulated Taps 6T Fine Thread Cannulated 6T Tap 4.8 4T Cannulated 6T Tap 5.5 4T Cannulated 6T Tap 6.5 4T Cannulated 6T Tap 7.2 4T Cannulated 6T Tap 8.5 4T

optional

optional

optional



Instruments

Item no.	Description
055059	Monoaxial Screw Driver Ø 5.5 mm
1001011000	Polyaxial Screw Inserter
055061	Polyaxial Screw Driver
055065	Polyaxial Screw Inserter
055064	Set Screw Driver
1001010065	Reposition Screw Driver optional
1010030009	Rescue Screw Driver
055081	Rod Pusher
055083	Bending Iron Ø 5.5 mm
055063	Counter Holder Ø 5.5 mm
055057	Phantom Rod Nitinol 200 mm
055273	Phantom Rod Nitinol 400 mm optional
1001010048	Rocker Ø 5.5 mm
055071	Approximator Clamp ø 5.5 mm

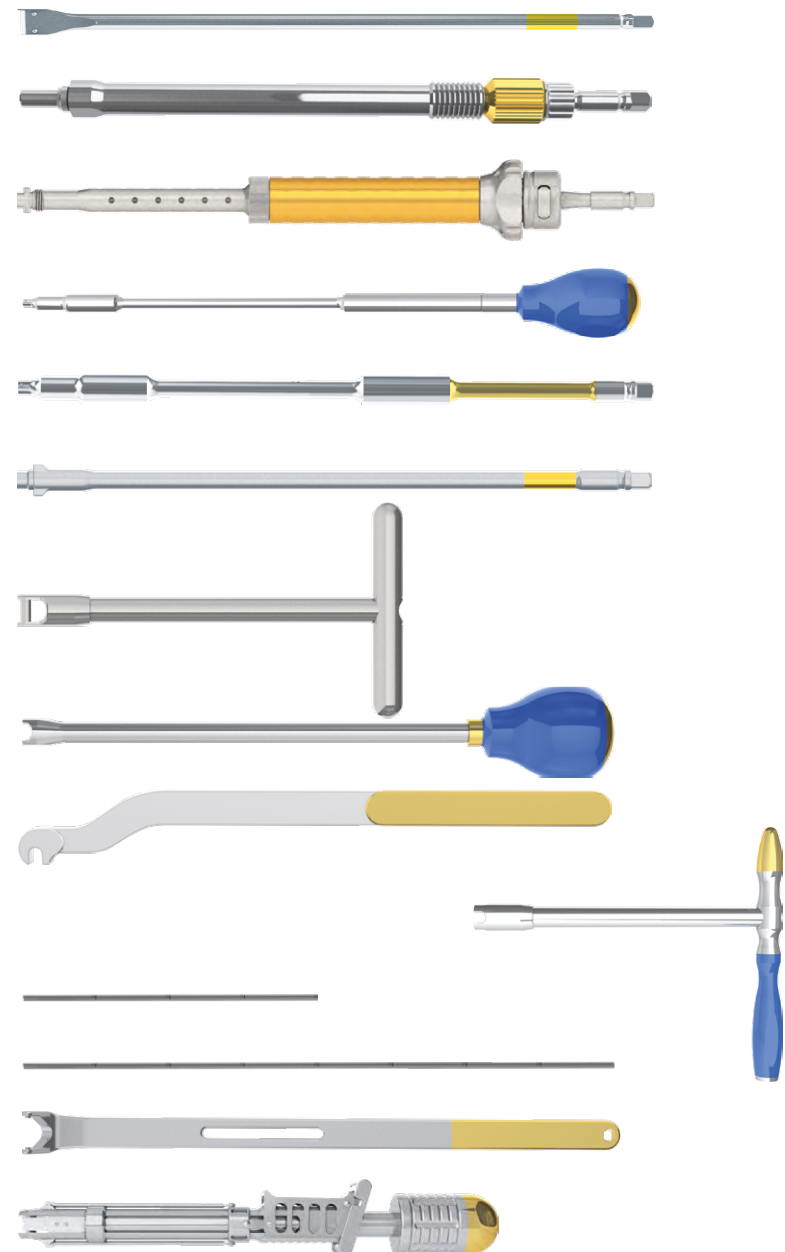

Item no.	Description	
1007010058	Persuader Forceps Style	
055077	T-Handle	
1006010600	T-Handle Cannulated	
055078	Ratchet T-Handle	
1006010700	Ratchet T-Handle Cannulated	
1006010701	Ratchet T-Handle Cannulated T-30	optional
055079	Handle Straight	
1006010900	Handle Straight Cannulated	
055080	Ratchet Handle Straight	
1006010800	Ratchet Handle Straight Cannulated	
1006010801	Ratchet Handle Straight Cannulated T-30	optional
1001012000	Torque Driver-12	



Item no.	Description
055259	Compressor
1001010049	Underrod Compressor optional
055262	Distractor
1001010046	Underrod Distractor optional
055293	Parallel Compressor AT
055294	Parallel Distractor AT

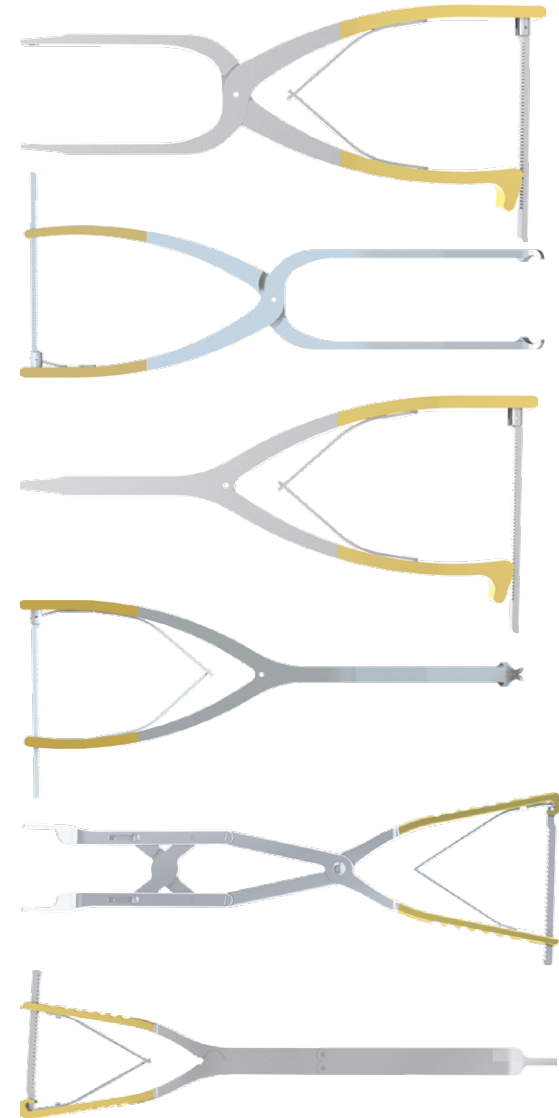

Item no.	Description
1001010050	Transverse Connector Inserter
1001010051	Transverse Connector Rod Holder
1001010052	Rod Inserter
055084	Rod Cutter 5.50 & 6.35
055069	Rod Bender
055072	Rod Holder



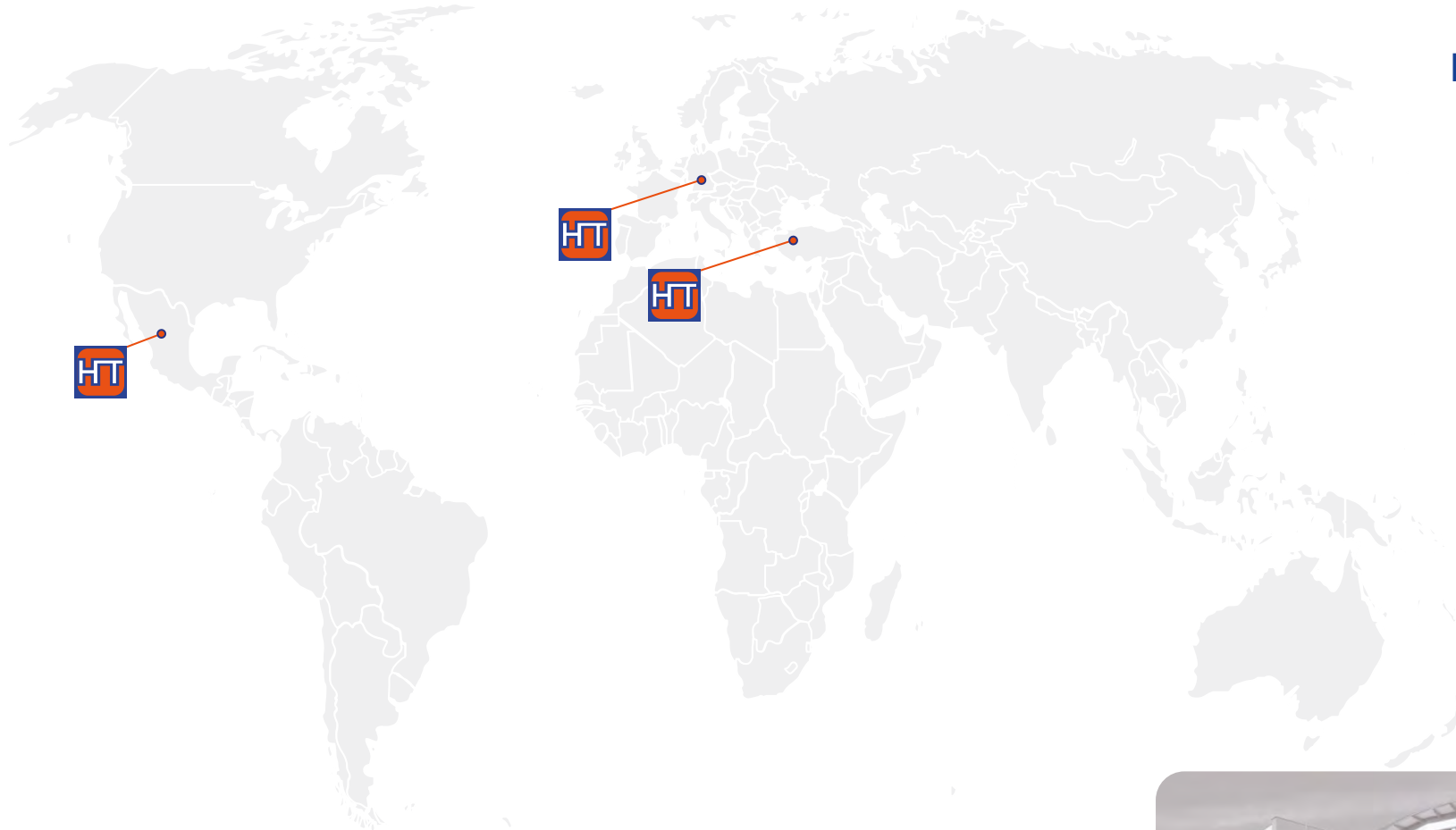

Manufacturing and sales

HumanTech Spine GmbH

Gewerbestr. 5
D-71144 Steinenbronn

Germany

Phone: +49 (0) 7157/5246-71
Fax: +49 (0) 7157/5246-66
sales@humantech-spine.de
www.humantech-spine.de

Middle East sales

HumanTech Med. Sag. Tic. Ltd.

İkitelli OSB Tümsan 2. Kısım
C-Blok No: 47
TR-34306 Başakşehir İstanbul

Turkey

Phone: +90 (0) 212/485 6675
Fax: +90 (0) 212/485 6674
info@humantech.com.tr
www.humantech-spine.de

Sales Latin America

HumanTech Mexico, S. DE R.L. DE C.V.

Rio Mixcoac No. 212-3
Acacias del Valle
Del. Benito Juárez
C.P. 03240 Mexico, D.F.
Mexico

Phone: +52 (0) 55/5534 5645
Fax: +52 (0) 55/5534 4929
info@humantech-solutions.mx
www.humantech-spine.de



Follow us on:

