

# CHM<sup>®</sup>

## Thoracolumbar spine stabilization system CHARSPINE2 MIS

- *IMPLANTS*
- *INSTRUMENT SET - BASIC 15.0913.101*
- *INSTRUMENT SET - BASIC 15.0913.202*
- *SURGICAL TECHNIQUE*

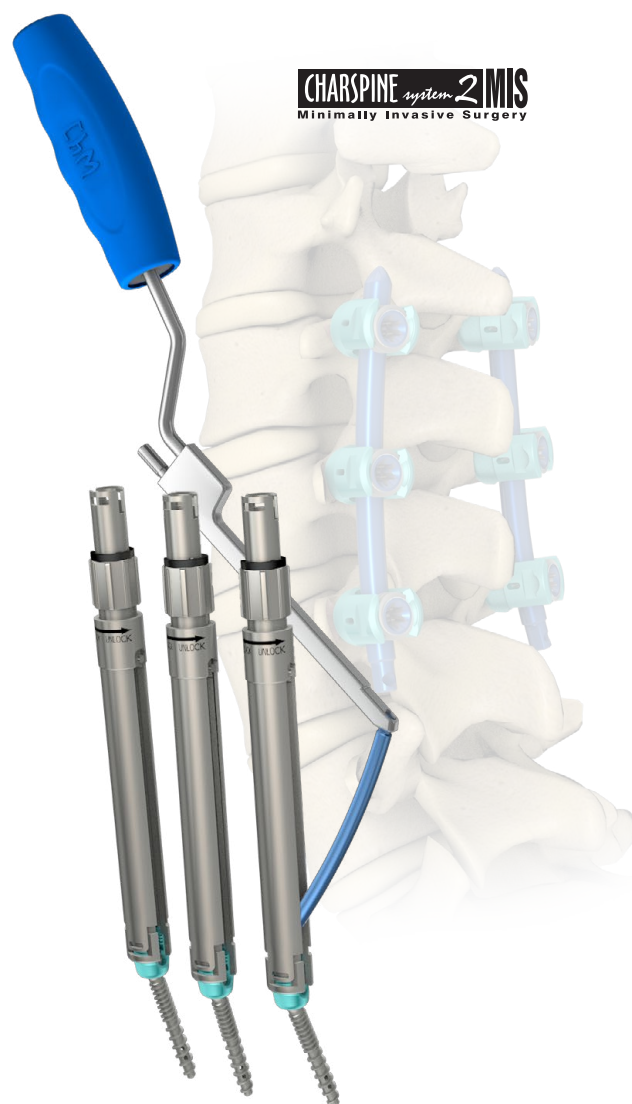

## SYMBOLS DESCRIPTIONS

---



Caution - pay attention to the particular proceeding.

---



Perform the activity with X-Ray control.

---



Information about the next stages of the proceeding.

---



Proceed to the next stage.

---



Return to the specified stage and repeat the activity.

---



Before using the product, carefully read the Instructions for Use supplied with the product. It contains, among others, indications, contraindications, side effects, recommendations and warnings related to the use of the product.

---



The above description is not a detailed instruction of conduct. The surgeon decides about choosing the operating procedure.

---

**[www.chm.eu](http://www.chm.eu)**

Document No            ST/86A  
Date of issue            28.05.2019  
Review date            P-002-03.04.2020

*The manufacturer reserves the right to introduce design changes.*

*Updated INSTRUCTIONS FOR USE are available at the following website: [www.chm.eu](http://www.chm.eu)*

<b>1. INTRODUCTION</b>	<b>4</b>
<b>2. IMPLANTS</b>	<b>5</b>
<b>3. INSTRUMENT SET</b>	<b>10</b>
3.1. CONTAINERS ARRANGEMENT	15
<b>4. SURGICAL TECHNIQUE</b>	<b>16</b>
4.1. Patient positioning	16
4.2. Marking the incision site	16
4.3. Trocar insertion	17
4.4. Guide rod insertion	18
4.5. Protective guides assembly	19
4.6. Screw insertion	19
4.7. Cement augmentation of screws ( <i>optional</i> )	26
4.8. Length measurement, use with the applicator, shaping and installation of the rod	28
4.9. Rod locking, distraction, compression, final tightening	30
<b>5. REVISION SURGERY</b>	<b>36</b>

## 1. INTRODUCTION

**CHARSPINE2 MIS** Thoracolumbar spine stabilization system is a set of implants designed for the treatment of the thoracic-lumbar spine using a minimally invasive technique. The system is used with the posterior approach (*from Th1 to S1*) in skeletally mature patients.

### INDICATIONS

---

Implants of the **CHARSPINE2 MIS** system enable treatment with restoration of the physiological curves of the affected motion segment of the spine through proper vertebral reposition.

#### Indications:

- degenerative disc disease (*DDD*),
- spondylolistheses,
- fractures and dislocations,
- deformities (*e.g.: scolioses, kyphoses*),
- tumours,
- stenoses,
- pseudoarthroses,
- failed previous fusion.

### CONTRAINDICATIONS

---

Contraindications may be relative or absolute. The choice of a particular device must be carefully considered in terms of patient's overall condition. Some conditions such as, e.g.:

- spine infection,
- morbid obesity,
- mental illness,
- alcohol or drug addiction,
- pregnancy,
- suspected or documented allergy or intolerance to implant materials, foreign bodies,
- inadequate tissue coverage or open wounds in the operative site, may preclude or reduce the chance of the successful outcome.



A detailed list of contraindications is provided in the Instructions for Use (*IFU*) for the product.

---

### WARNINGS

---

The safety and effectiveness of spinal systems based on the transpedicular screws stabilization have been established only for diseases of the spine caused by significant mechanical instability or deformities requiring surgical immobilization. The safety and effectiveness of these systems for other conditions remain unknown. A successful result is not always achieved in every surgical case. This fact is especially true in the cases where other patient's conditions may compromise the results. The proper patient selection, compliance of the patient and observance of post-operative recommendations will greatly affect the results. It has been proven that the bone union is less likely to occur among smoking patients. These patients should be informed about this fact and warned of this consequence.



A detailed list of warnings, precautions and postoperative recommendations is provided in the Instructions for Use (*IFU*) for the product.

---



Implants of the **CHARSPINE2 MIS** system manufactured by **ChM** sp. z o.o. were designed and tested only for use with the **ChM** instrument set intended to be used with them. This surgical technique is intended as a guide only. As with any other surgical procedure, the surgeon should be thoroughly trained before surgery and must consider the individual needs of each patient.

---

## 2. IMPLANTS

### Main features and benefits

The presented implants and instruments are designed for posterior approach using a minimally invasive technique. The offered range of implants is made of titanium and its alloys and cobalt alloy in accordance with ISO 5832 standard. Compliance with the requirements of quality management systems and the requirements of Directive 93/42/EEC concerning medical devices guarantee high quality of the offered implants.

### CHARSPINE2 MIS Polyaxial screw

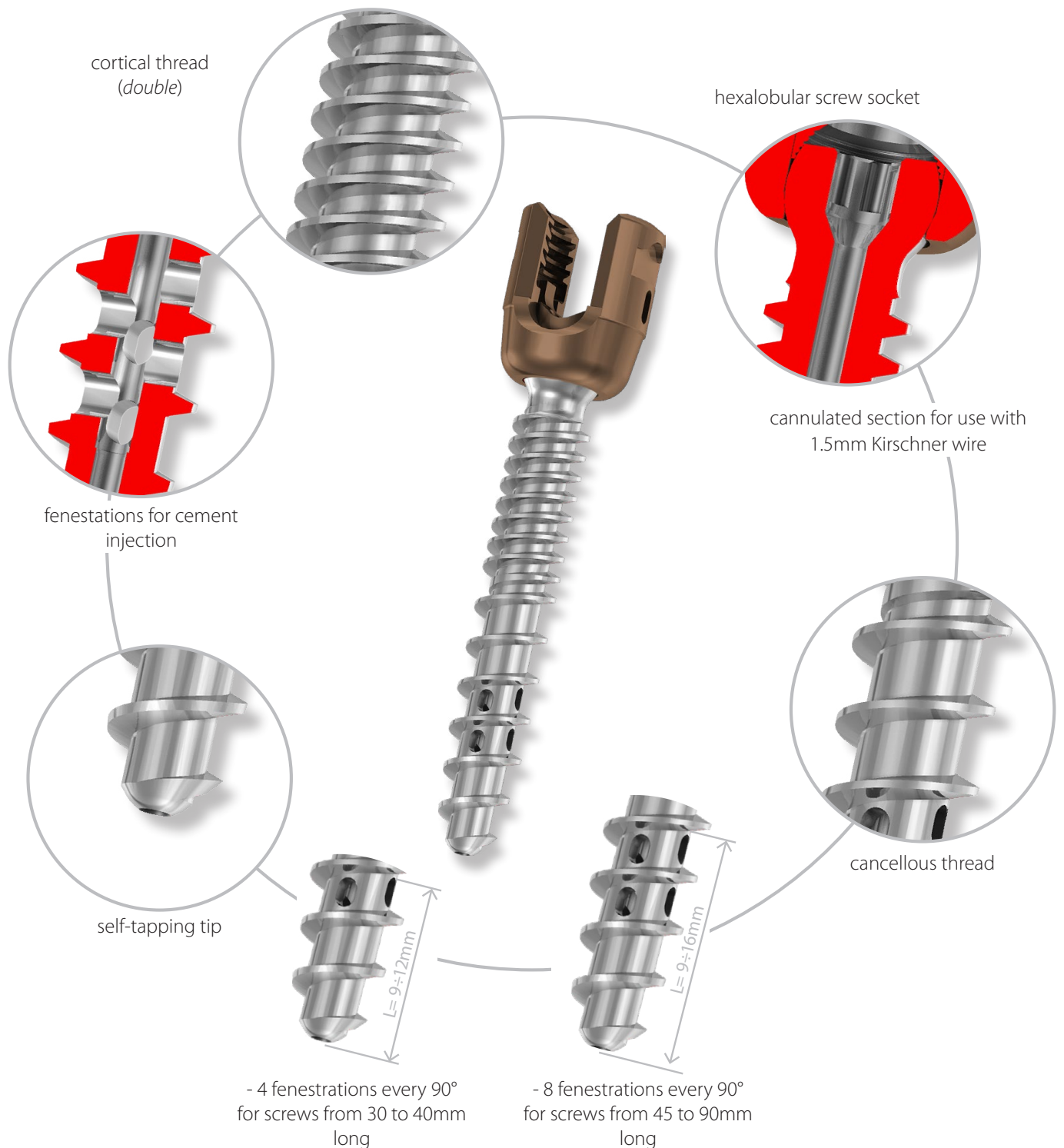

CHARSPINE2 MIS POLYAXIAL SCREW

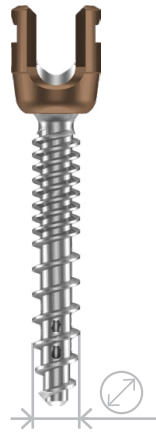

CHARSPINE2 LOCKING SCREW



Ti



3.6160.000



Ø4.5   Ø5.0   Ø5.5   Ø6.0   Ø6.5   Ø7.0   Ø7.5   Ø8.5   Ø9.5   Ø10.5



Len	Ti	Len	Ti
30	3.6565.030	30	3.6572.030
4.5	35 3.6565.035	35	3.6572.035
	40 3.6565.040	40	3.6572.040
	45 3.6565.045	45	3.6572.045
	30 3.6566.030	50	3.6572.050
5.0	35 3.6566.035	55	3.6572.055
	40 3.6566.040	60	3.6572.060
	45 3.6566.045	65	3.6572.065
5.5	30 3.6567.030	70	3.6572.070
	35 3.6567.035	75	3.6572.075
	40 3.6567.040	80	3.6572.080
	45 3.6567.045	85	3.6572.085
	50 3.6567.050	90	3.6572.090
	55 3.6567.055	30	3.6573.030
	60 3.6567.060	35	3.6573.035
6.0	65 3.6567.065	40	3.6573.040
	30 3.6568.030	45	3.6573.045
	35 3.6568.035	50	3.6573.050
	40 3.6568.040	55	3.6573.055
	45 3.6568.045	60	3.6573.060
	50 3.6568.050	65	3.6573.065
	55 3.6568.055	70	3.6573.070
6.5	60 3.6568.060	75	3.6573.075
	65 3.6568.065	80	3.6573.080
	30 3.6569.030	85	3.6573.085
	35 3.6569.035	90	3.6573.090
	40 3.6569.040	30	3.6574.030
	45 3.6569.045	35	3.6574.035
	50 3.6569.050	40	3.6574.040
7.0	55 3.6569.055	45	3.6574.045
	60 3.6569.060	50	3.6574.050
	65 3.6569.065	55	3.6574.055
	30 3.6570.030	60	3.6574.060
	35 3.6570.035	65	3.6574.065
	40 3.6570.040	70	3.6574.070
	45 3.6570.045	75	3.6574.075
7.5	50 3.6570.050	80	3.6574.080
	55 3.6570.055	85	3.6574.085
	60 3.6570.060	90	3.6574.090
	65 3.6570.065		
	30 3.6571.030		
	35 3.6571.035		
	40 3.6571.040		
8.5	45 3.6571.045		
	50 3.6571.050		
	55 3.6571.055		
	60 3.6571.060		
	65 3.6571.065		
	70 3.6571.070		
	75 3.6571.075		
	80 3.6571.080		
	85 3.6571.085		
	90 3.6571.090		

## CHARSPINE2 MIS Rod 6

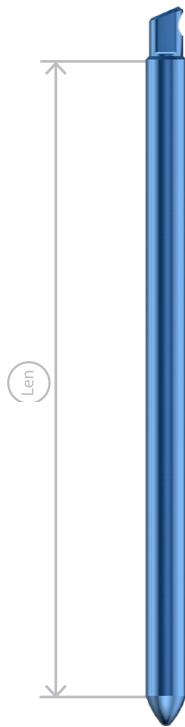

Len	Ti
30	3.6900.030
35	3.6900.035
40	3.6900.040
45	3.6900.045
50	3.6900.050
55	3.6900.055
60	3.6900.060
65	3.6900.065
70	3.6900.070
75	3.6900.075
80	3.6900.080
85	3.6900.085
90	3.6900.090
95	3.6900.095
100	3.6900.100
110	3.6900.110
120	3.6900.120
130	3.6900.130
140	3.6900.140
150	3.6900.150
160	3.6900.160
170	3.6900.170
180	3.6900.180
190	3.6900.190
200	3.6900.200
300	3.6900.300
400	3.6900.400
500	3.6900.500
600	3.6900.600

## CHARSPINE2 MIS Hard rod 6

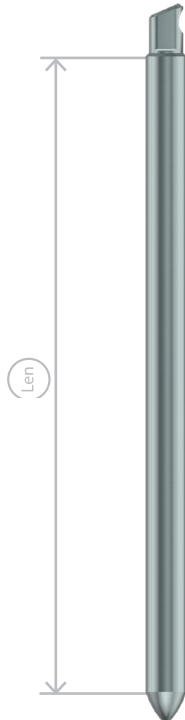

Len	Co
30	4.6900.030
35	4.6900.035
40	4.6900.040
45	4.6900.045
50	4.6900.050
55	4.6900.055
60	4.6900.060
65	4.6900.065
70	4.6900.070
75	4.6900.075
80	4.6900.080
85	4.6900.085
90	4.6900.090
95	4.6900.095
100	4.6900.100
110	4.6900.110
120	4.6900.120
130	4.6900.130
140	4.6900.140
150	4.6900.150
160	4.6900.160
170	4.6900.170
180	4.6900.180
190	4.6900.190
200	4.6900.200
300	4.6900.300
400	4.6900.400
500	4.6900.500
600	4.6900.600

## CHARSPINE2 MIS Curved rod 6

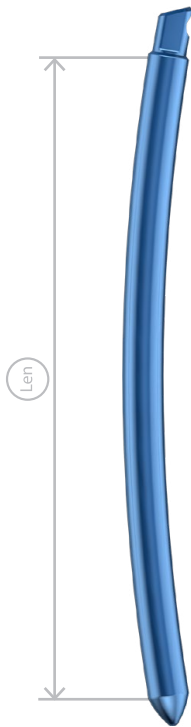

Len	Ti
30	3.6901.030
35	3.6901.035
40	3.6901.040
45	3.6901.045
50	3.6901.050
55	3.6901.055
60	3.6901.060
65	3.6901.065
70	3.6901.070
75	3.6901.075
80	3.6901.080
85	3.6901.085
90	3.6901.090
95	3.6901.095
100	3.6901.100
110	3.6901.110
120	3.6901.120
130	3.6901.130
140	3.6901.140
150	3.6901.150
160	3.6901.160
170	3.6901.170
180	3.6901.180
190	3.6901.190
200	3.6901.200

## CHARSPINE2 MIS Curved hard rod 6



Len	Co
30	4.6901.030
35	4.6901.035
40	4.6901.040
45	4.6901.045
50	4.6901.050
55	4.6901.055
60	4.6901.060
65	4.6901.065
70	4.6901.070
75	4.6901.075
80	4.6901.080
85	4.6901.085
90	4.6901.090
95	4.6901.095
100	4.6901.100
110	4.6901.110
120	4.6901.120
130	4.6901.130
140	4.6901.140
150	4.6901.150
160	4.6901.160
170	4.6901.170
180	4.6901.180
190	4.6901.190
200	4.6901.200



40.8593.000  
 PALETTE FOR CHARSPINE2 MIS IMPLANTS - RODS









Screw diameter	Length L	Quantity
5.0	30	2
	35	2
	40	2
	45	2
5.5	35	6
	40	6
	45	6
	50	6
	55	6
	60	6
6.0	35	6
	40	6
	45	6
	50	6
	55	6
	60	6
6.5	35	6
	40	6
	45	6
	50	6
	55	6
	60	6
7.0	35	6
	40	6
	45	6
	50	6
	55	6
	60	6
7.5	35	2
	40	2
	45	2
	50	2
	55	2
	60	2
Polyaxial screws		
Locking screw	-	-
	30	1
	35	1
	40	1
	45	1
	50	1
	55	1
	60	1
	65	1
	70	1
	75	1
80	1	
85	1	
90	1	
95	1	
100	1	
110	1	
120	1	
130	1	
140	1	
150	1	
160	1	
Rods		

## 3. INSTRUMENT SET







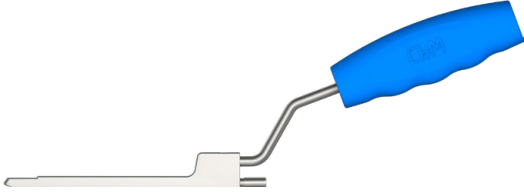
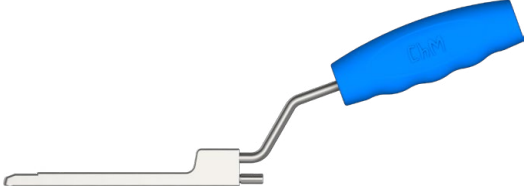



The CHARSPINE2 MIS polyaxial screws instrument set consists of the following modules:



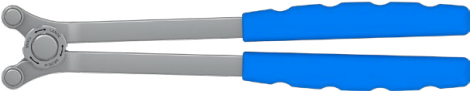

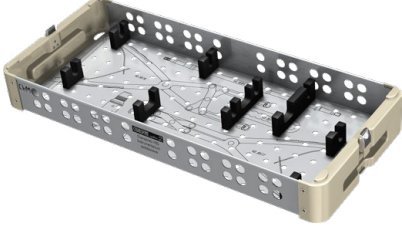

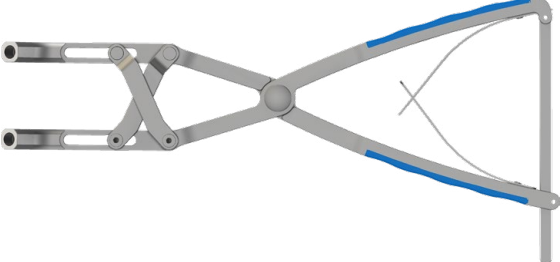



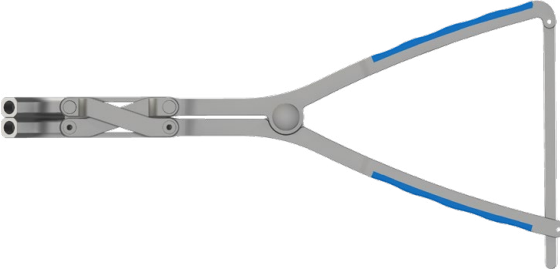

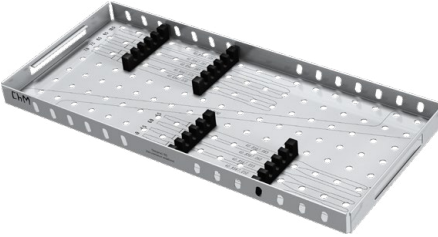



- CHARSPINE2 MIS Instrument set - basic [15.0913.101]
- CHARSPINE2 MIS Instrument set - additional 1 [15.0913.202]

CHARSPINE2 MIS Instrument set - basic [15.0913.101]			
CHARSPINE2 MIS Instrument set	Name	Catalogue no.	Pcs
	Container 9x4H	14.0913.101	1
	<b>Protective guide I</b> Protective guide is used to expose the operating field.	40.8562.000	1
	<b>Protective guide II</b> Protective guide is used to expose the operating field.	40.8563.000	1
	<b>Protective guide III</b> Protective guide is used to expose the operating field.	40.8564.000	1
	<b>Trocar</b> Trocar is used to penetrate the cortical layer of the arch and insert the guide rod.	40.8561.000	1
	<b>Screwdriver T30</b> Screwdriver T30 is used for the insertion and initial locking of the locking screws. With the rod impactor, a set is used to press the rod to the bottom of the pedicle screw socket.	40.8574.000	1
	<b>Screwdriver T30</b> Screwdriver T30 is intended for use for removal of the locking screw in revision procedures.	40.8111.000	1
	<b>Applicator</b> Applicator is used to insert the spinal rod.	40.8571.000	1
	<b>Applicator</b> Applicator is used to insert the spinal rod.	40.8572.000	1

## CHARSPINE2 MIS Instrument set - basic [15.0913.101]







CHARSPINE2 MIS Instrument set	Name	Catalogue no.	Pcs
	Container 9x4H	14.0913.102	1
	<b>Oval head ratchet handle</b> Oval head ratchet handle is used with wrenches for screws and cortical taps (interchangeably with T-type ratchet handle 40.8085.000).	40.8086.000	2
	<b>Manual cannulated reamer</b> The reamer is used to prepare the holes in the pedicles of vertebral arches.	40.8565.000	1
	<b>Gauge</b> Gauge is used to measure the length of the rod	40.8570.000	1
	<b>Bone rasp</b> Bone rasp is used to prepare the pedicle for the transpedicular screw head.	40.8566.000	1
	<b>Adjustable rod bender</b> Adjustable rod bender is used to bend the rod to desired shape	40.8074.000	1
	<b>Wrench for polyaxial screws</b> Wrench for polyaxial screws is used for mounting and insertion of <b>CHARSPINE2 MIS</b> polyaxial transpedicular screws. It is intended for use with oval head ratchet handle.	40.8568.000	2
	<b>Rod trial 6/300</b> Rod trials are used for initial rough assessment of the size and shape of the spinal rod in the spinal stabilization procedures using transpedicular screws.	40.5246.300	2
	Container 9x4H	14.0913.103	1
	<b>Screwdriver tip T30</b> Screwdriver tip T30 is used with a T-type torque handle 12Nm [40.8087.000] for nal locking of transpedicular screws, hooks and lateral connectors.	40.8084.000	1
	<b>Reposition plate</b> Reposition plate is used in compression and distraction procedures. Guide sleeves are inserted into the holes in the plate.	40.8578.000	1
	<b>Parallel compression forceps</b> The forceps are used with protective guide II and are intended for procedure of vertebrae compression.	40.8576.000	1

## CHARSPINE2 MIS Instrument set - basic [15.0913.101]

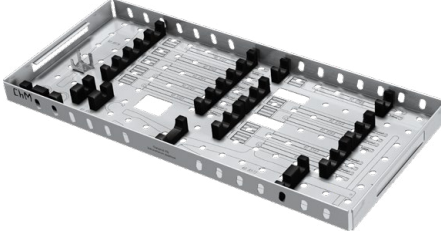
CHARSPINE2 MIS Instrument set	Name	Catalogue no.	Pcs
	<b>Parallel distraction forceps</b> The forceps are used with protective guide II and are intended for procedure of vertebrae distraction.	40.8577.000	1
	<b>T-type torque handle 12Nm</b> T-type torque handle 12Nm is intended to be used with screwdriver tip T30 [40.8084.000] and is used for nal tightening of the locking screws into the transpedicular screws, hooks and lateral connectors.	40.8087.000	1
	<b>Tray 9x4 1/2H</b>	14.0913.201	1
	<b>Cortical tap 4.5</b>	40.8567.045	1
	<b>Cortical tap 5.0</b>	40.8567.050	1
	<b>Cortical tap 5.5</b>	40.8567.055	1
	<b>Cortical tap 6.0</b>	40.8567.060	1
	<b>Cortical tap 6.5</b>	40.8567.065	1
	<b>Cortical tap 7.0</b>	40.8567.070	1
	<b>Cortical tap 7.5</b>	40.8567.075	1
	<b>Cortical tap 8.5</b>	40.8567.085	1
	<b>Cortical tap 9.5</b>	40.8567.095	1
	<b>Cortical tap 10.5</b>	40.8567.105	1
	<b>Stand</b> Stand is used to store the guide rods 1.5/500.	40.8590.000	1
	<b>Guide rod 1.5/500</b> Blunt rod. It is the guiding element for other instruments, e.g. used for screws insertion.	40.8559.000	10
	<b>Container lid 9x4</b>	14.0913.104	1

Cortical taps are intended for usage with ratchet handles [40.8085.000] or [40.8086.000] and may be used for tapping the vertebral arch pedicles prior to screw insertion.

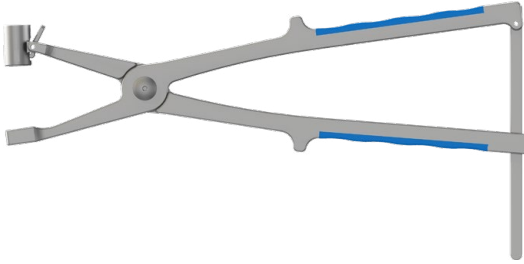









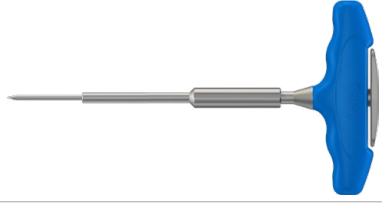

## CHARSPINE2 MIS Instrument set - additional 1 [15.0913.202]

CHARSPINE2 MIS Instrument set - additional 1	Name	Catalogue no.	Pcs
	Tray 9x4 1/2H	14.0913.202	1
	<b>Counter wrench</b> Counter wrench is used to ensure rotational stability of the implants during nal tightening of the locking screws.	40.8579.000	1
	<b>Guide II</b> Guides II are used with distraction and compression forceps.	40.8575.000	2
	<b>Wrench</b> Wrench facilitates the removal of the guide sleeve and tightening of the cannula for bone cement.	40.8580.000	1
	<b>Rod impactor</b> Rod impactor with screwdriver T30 is used to push the rod to the bottom of the screw.	40.8573.000	1
	<b>Guide sleeve</b> Guide sleeve when attached to the screw, facilitates the introduction of the spinal rod, allows the insertion of the locking screw, cooperates with instruments used in distraction, compression and rod positioning procedures.	40.8569.000	10



Instruments mentioned below are not included in the standard instrument set.

In order to include them to the ordered CHARSPINE2 MIS instruments, please contact your local representative or ChM Sales Department.

	Name	Catalogue no.	Pcs
	<b>Cannula for bone cement</b> Single use cannula for bone cement is intended to be used with the head of the CHARSPINE2 MIS screw. The universal Luer thread allows the cannula to be connected with the mixing and delivery system for bone cement.	40.8591.000	1
	<b>Alignment trial for cannula</b> Alignment trial for cannula, inserted through the cannula for bone cement attached to the CHARSPINE2 MIS screw, is intended to confirm the coaxiality of the holes in the cannula and screw.	40.8592.000	1
	<b>Trocar</b> Trocar is used as an alternative to the standard trocar [40,8561.000] in situations where the surgical conditions or the surgeon's preferences require the use of a shorter instrument.	40.8601.000	1
	<b>Connector</b> Connector is used with distraction forceps; can be used when decompression of a broken vertebra is required.	40.8595.000	1
	<b>Guide rod 1.5/500</b> Rod with a sharp tip; used as a guiding element for other instruments, e.g. for screws insertion.	40.8560.000	1
	<b>Guide rod 1.5/500</b> Rod with a sharp threaded ( <i>self-drilling</i> ) tip; used as a guiding element for other instruments, e.g. for screws insertion.	40.8558.000	1
	<b>Guide rod 1.5/500</b> Rod with a blunt threaded tip; used as a guiding element for other instruments, e.g. for screws insertion.	40.8557.000	1
	<b>Guide rod 1.5/600</b> Non-standard, longer (600mm) rod with a blunt tip.	40.8559.600	1
	<b>Guide rod 1.5/600</b> Non-standard, longer (600mm) rod with a sharp tip.	40.8560.600	1
	<b>Guide rod 1.5/600</b> Non-standard, longer (600mm) rod with a sharp threaded ( <i>self-drilling</i> ) tip	40.8558.600	1
	<b>Guide rod 1.5/600</b> Non-standard, longer (600mm) rod with a blunt threaded tip.	40.8557.600	1
	<b>Container</b> Container for storage and sterilization of 600mm guide rods.	40.8555.000	1

## 3.1. CONTAINERS ARRANGEMENT

Containers for basic instrument set [15.0913.101] and additional instruments [15.0913.202]

No.	Name	Catalogue No.	Pcs
1	Container lid 9x4	14.0913.104	2
2	Tray 9x4 1/2H	14.0913.201	1
3	Container 9x4H	14.0913.101	1
4	Tray 9x4 1/2H	14.0913.202	1
5	Container 9x4H	14.0913.103	1
6	Container 9x4H	14.0913.102	1



## 4. SURGICAL TECHNIQUE

### 4.1. PATIENT POSITIONING

The patient is placed prone on rubber-foam supports. In order to avoid pressure and bed-sores, a bolster is used to support the mouth, nose and eyes. Make sure the patient's stomach is free of pressure. This is especially important when decompressing the spine, since a compressed abdomen can cause venous congestion and, as a result, increased intraoperative bleeding.

### 4.2. MARKING THE INCISION SITE

Using the A/P imaging, determine the lines running centrally through the vertebral pedicles at the levels to be treated.

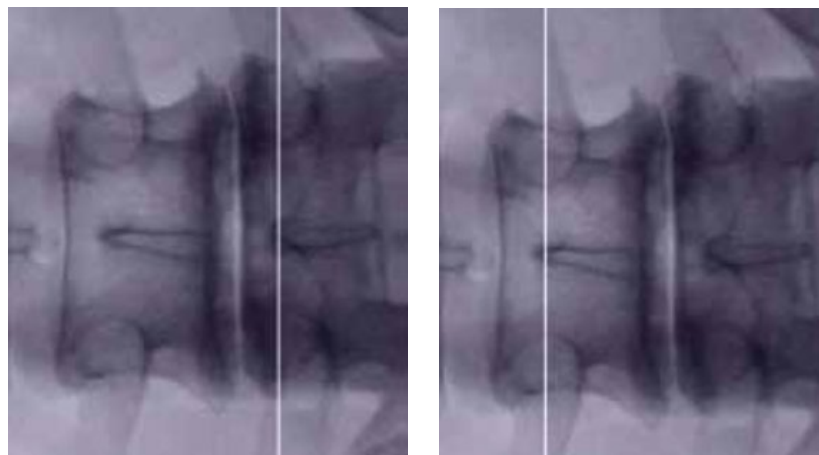

The AP imaging should be done carefully. The pedicles should be symmetrical and the spinous process should be located centrally between the pedicles. The upper endplate should be parallel to the X-Ray direction emitted by the C-arm.



The insertion point for the transpedicular screws is located at the intersection of a line running centrally through the pedicles and a line parallel to the center line and about 4cm off that line. At the intersection, incision about 1.5cm long should be made. Should the surgical approach be hindered, the incisions may be widened.

Central line

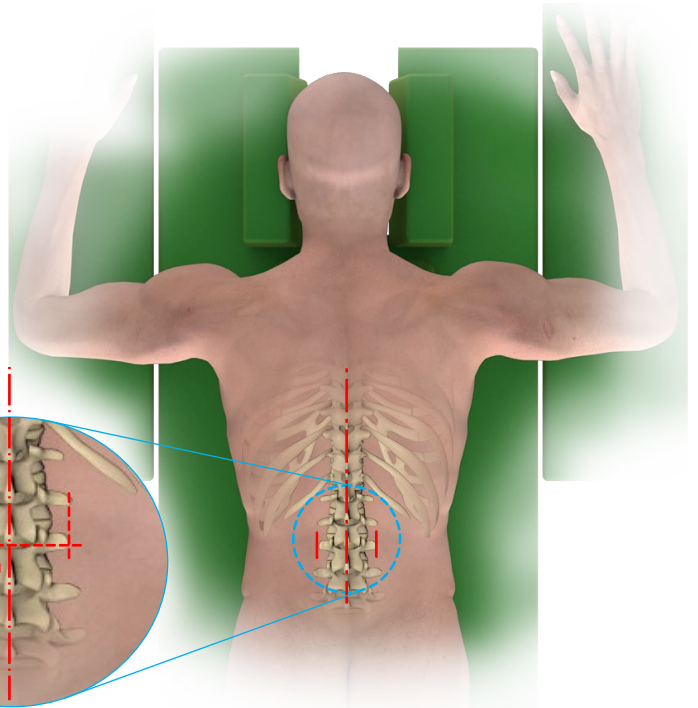
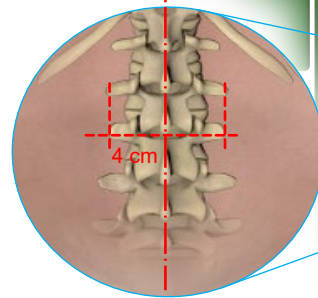

### 4.3. TROCAR INSERTION

Trocar **[40.8561.000]** should be gently inserted through the incision towards the insertion point at the pedicle arch. This point is located at the intersection of the line dividing the transverse processes in half and the line running along the lateral edge of the upper articular process.



40.8561.000

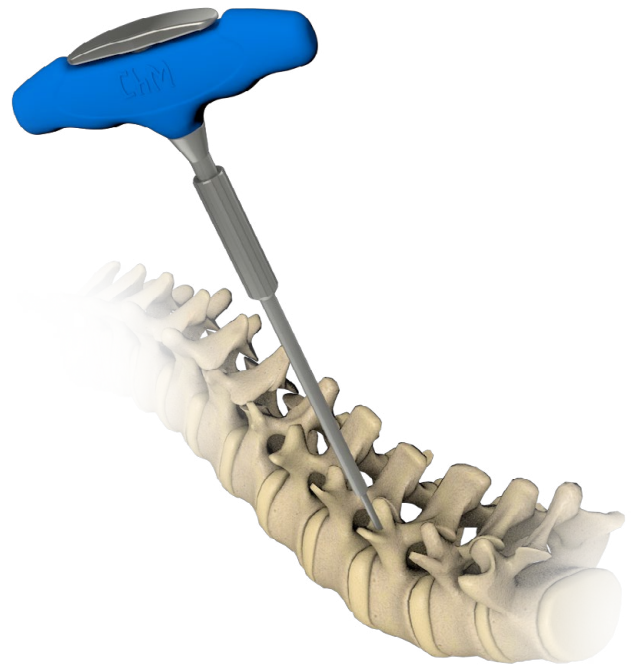
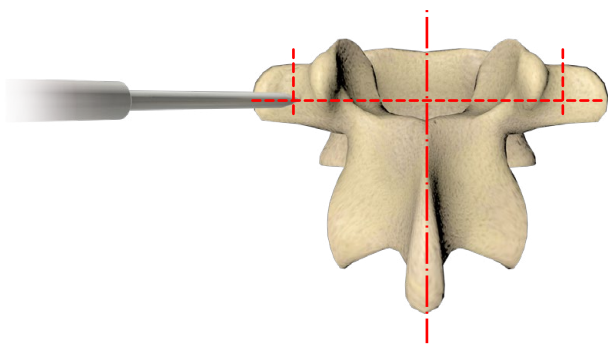

When the trocar tip rests against the bone, confirm its positioning by taking lateral and A/P images. Then insert the trocar through the pedicle into the vertebral body to the desired depth. Confirm correct insertion of the trocar.

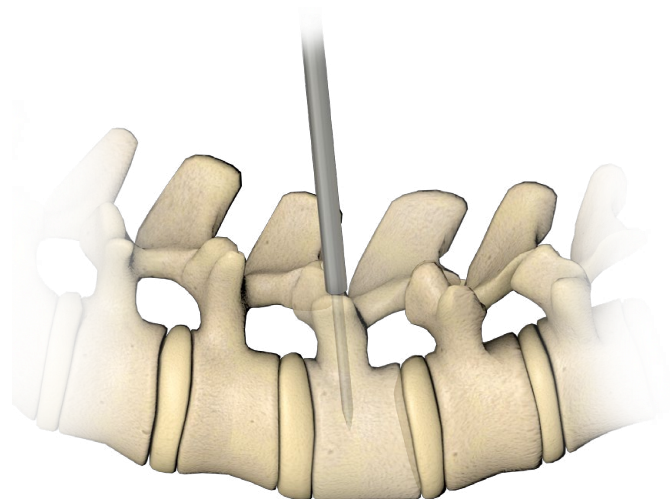



The trocar is equipped with a depth limiter that determines the depth of insertion of the trocar tip. The depth limiter may also be used to determine the length of the screw to be used.

Depth of insertion.

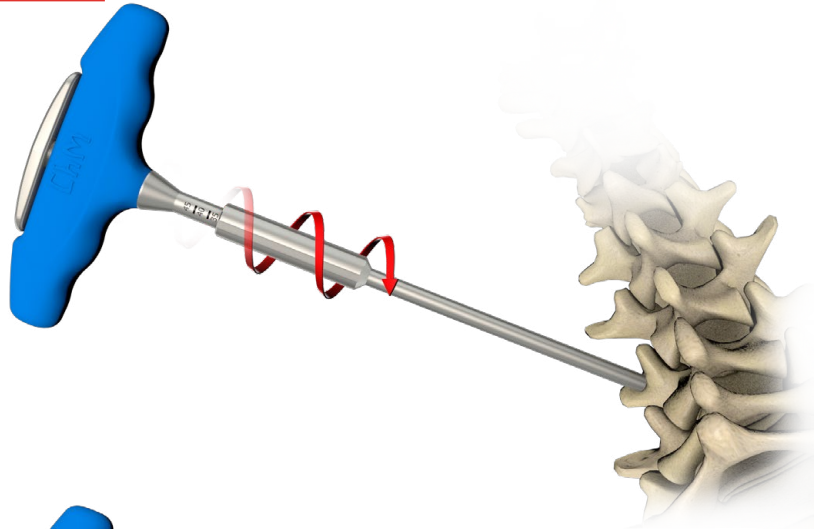

After trocar insertion, remove the pin.

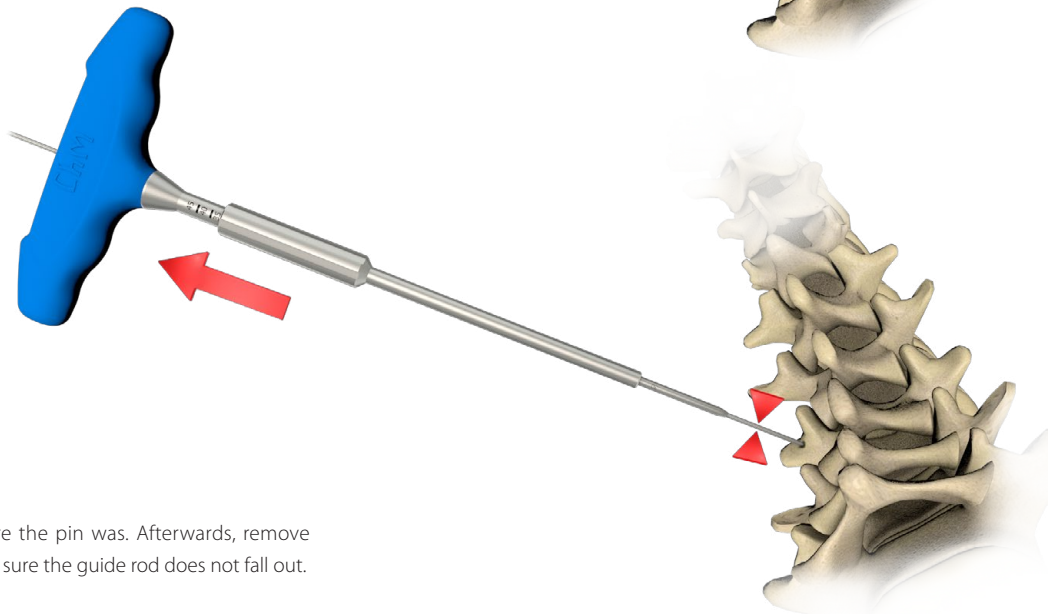
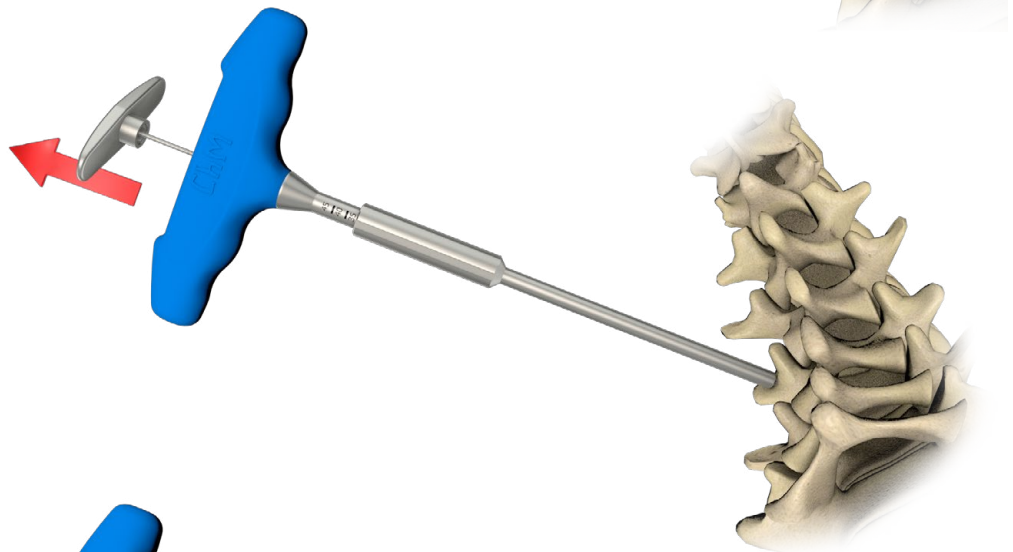

#### 4.4. GUIDE ROD INSERTION

Insert the guide rod **[40.8559.000]** where the pin was. Afterwards, remove the trocar. When removing the trocar, make sure the guide rod does not fall out.

---



---

40.8559.000

## 4.5. PROTECTIVE GUIDES ASSEMBLY

Protective guides [40.8562.000], [40.8563.000], [40.8564.000] provide tissue protection and facilitate instruments insertion. Use guide rod to insert protective guide I and protective guide II one after the other. Then, remove the protective guide I leaving the protective guide II.

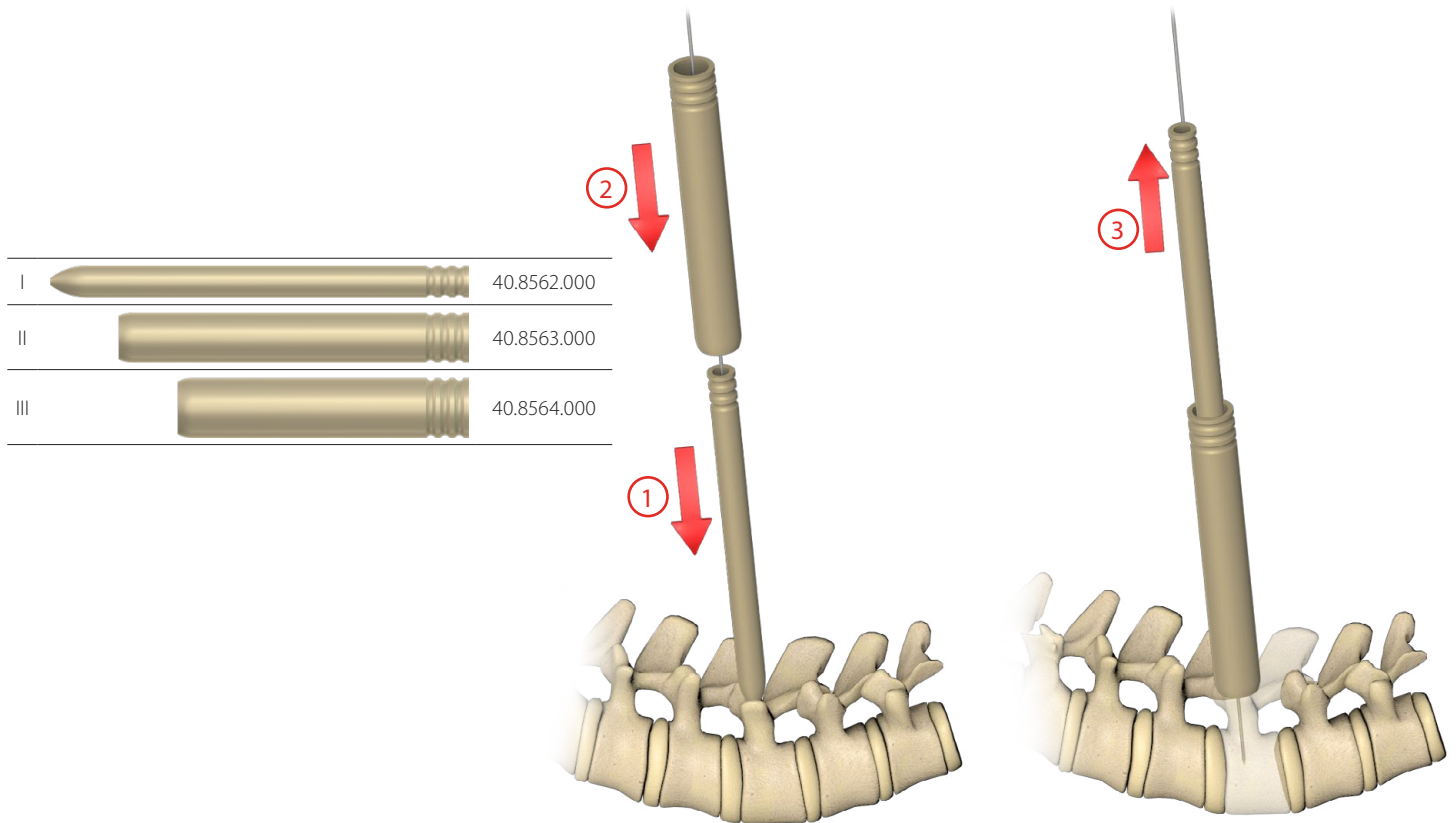

## 4.6. SCREW INSERTION

### 4.6.1. PREPARATION OF THE PEDICLE OF VERTEBRAL ARCH

Attach manual cannulated reamer [40.8565.000] to the oval head ratchet handle [40.8086.000].

Introduce the combined instrument applying pressure to the handle and making gentle rotational and swinging movements until the reamer rests on the bone (the reamer stops sinking into the pedicle).

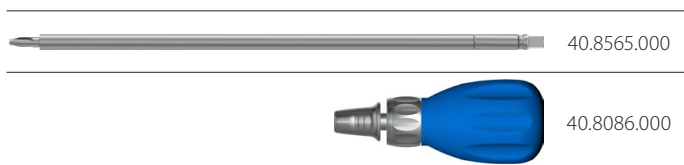

#### 4.6.2. REAMING OF TRANSVERSE AND ARTICULAR PROCESSES (OPTIONAL)

Remove the oval head ratchet handle [40.8086.000] from the manual cannulated reamer leaving it embedded in the pedicle.

Introduce bone rasp [40.8566.000] on the reamer and applying pressure to the rasp, make gentle rotational and swinging movements. When the marker on the reamer aligns with the horizontal hole in the bone rasp, the bottom edge of the rasp is level with the bearing surface of the reamer.

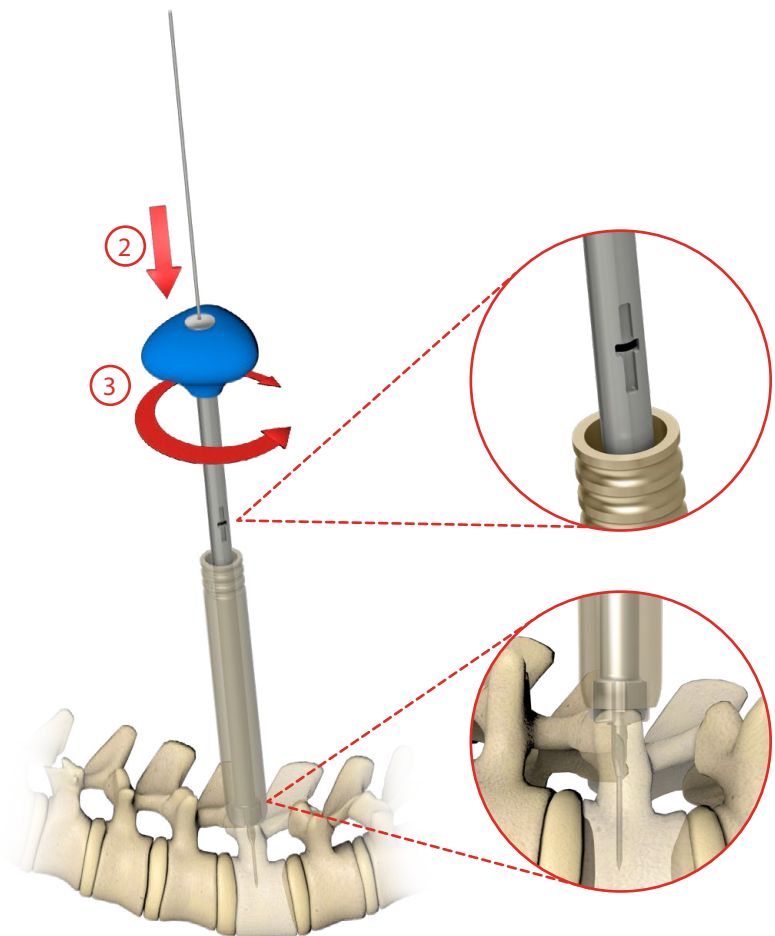
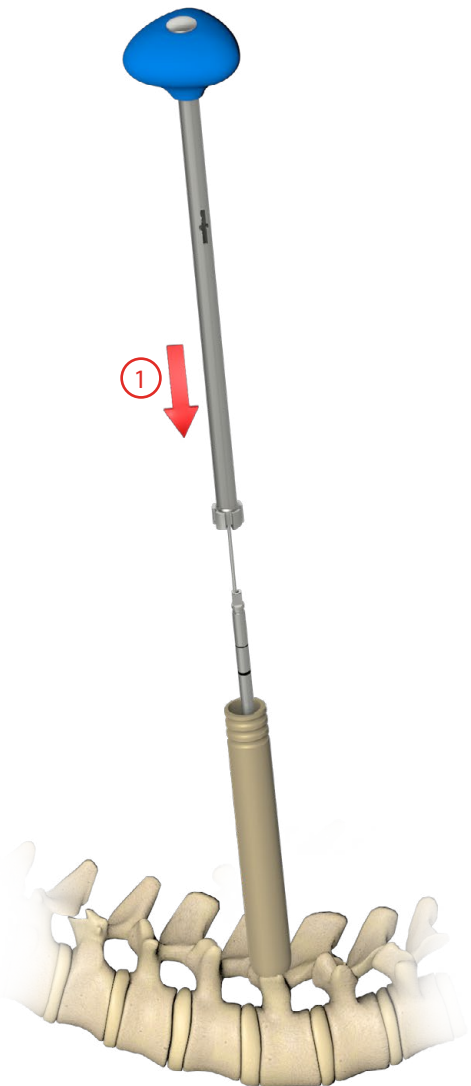
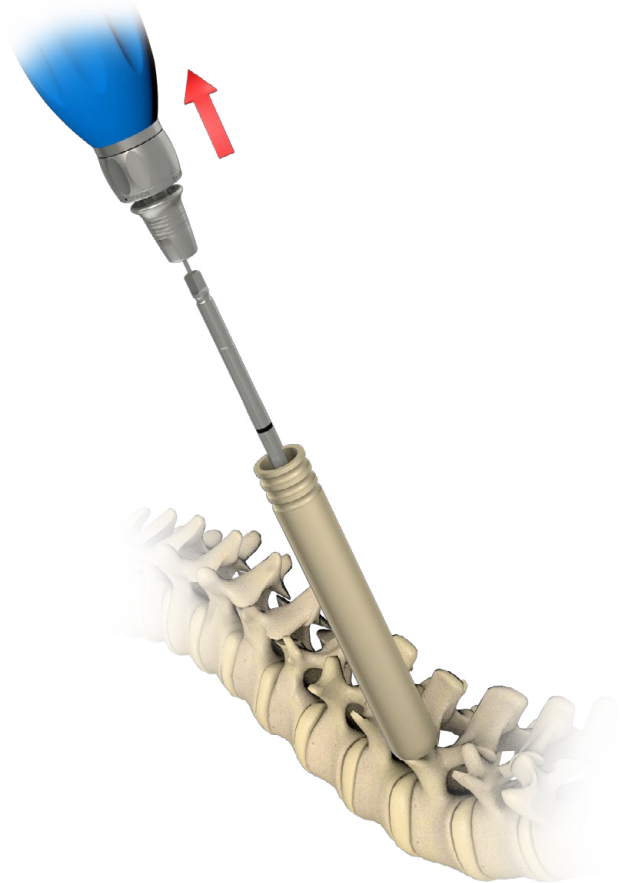

Carefully remove the rasp and reamer, protecting the guide rod from being pulled out of the pedicle.

4.6.3. HOLES THREADING (OPTIONAL)

**CHARSPINE2 MIS** screws are self-tapping, therefore, in most cases, there is no need to thread the pedicles of vertebral arches. However, for clinical cases requiring threading, cortical taps [40.8567.045-40.8567.105] mounted in the oval head ratchet handle [40.8086.000] can be used. There is a scale marked on the taps that allows for rough determination of the depth at which the tap has been inserted (before threading, define the number of scale that levels with the upper edge of the protective guide, then after finishing the threading, a second reading is made accordingly; the difference between the readings is equal to the approximate depth of the tap insertion).



**CAUTION**

During threading, be careful and do not change the position of the protective guide as this may result in an incorrect reading of the threading depth.

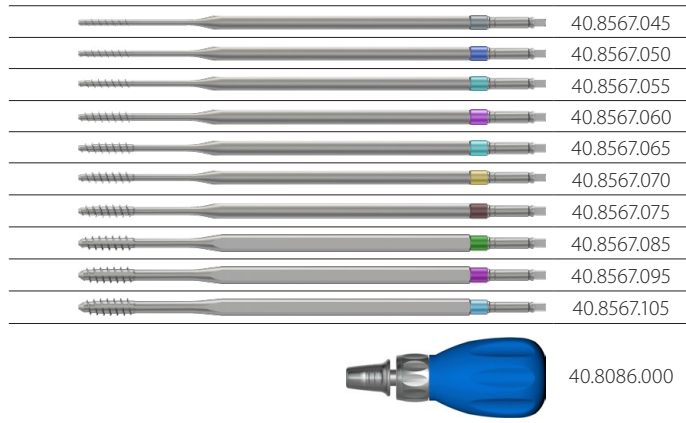

4.6.4. TRANSPEDICULAR SCREW-TO-GUIDE SLEEVE CONNECTION

Turn the sleeve wheel towards UNLOCK to set the outer sleeve of the guide sleeve [40.8569.000] as shown in the picture.



Then press the screw into the sleeve until locked.

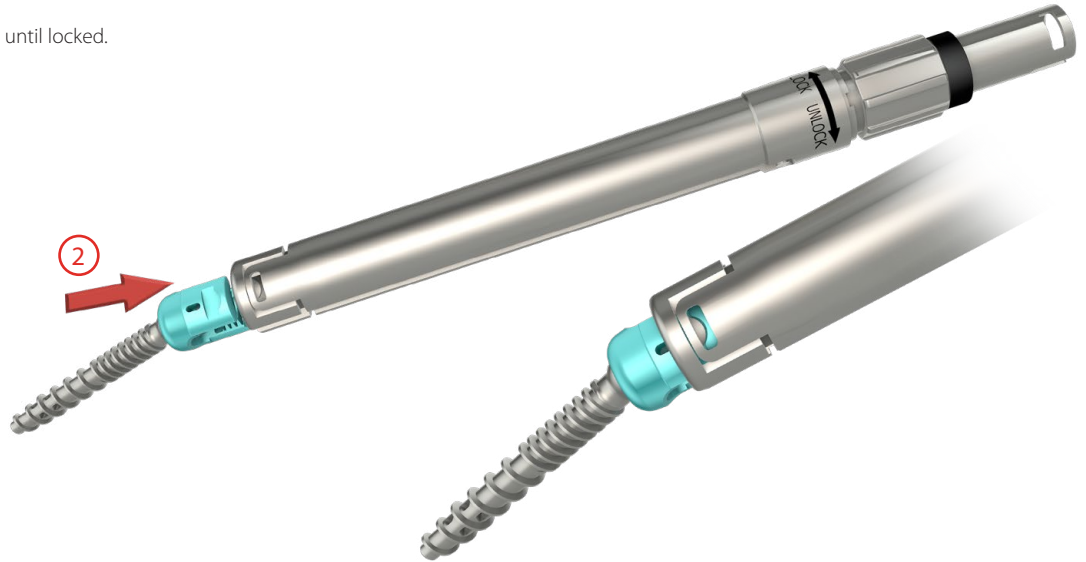

Turn the sleeve wheel towards LOCK to lock the screw and secure it against uncontrolled falling out. The catch lock of the outer sleeve after locking should be in the position as shown in the picture.



4.6.5. SCREWS INSERTION

The instrument set includes two wrenches for polyaxial screws **[40.8568.000]**. These wrenches are designed for use with oval head ratchet handle **[40.8086.000]** and are equipped with a ratchet mechanism that prevents loosening of the tip-screw connection during insertion. To disconnect the shaft from the wrench **[40.8568.000]**, turn the wrench knob to DISMOUNT position, press and hold the place on the wrench marked as PUSH, and then remove the shaft out of the wrench sleeve.

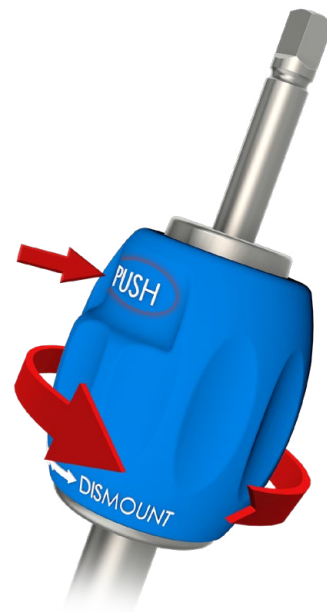
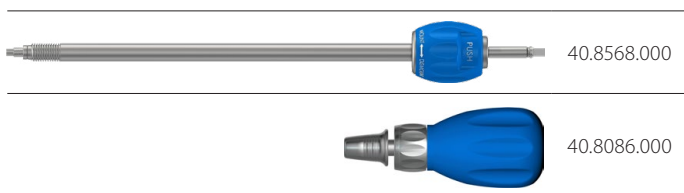

Attach the wrench to oval head ratchet handle [40.8086.000].

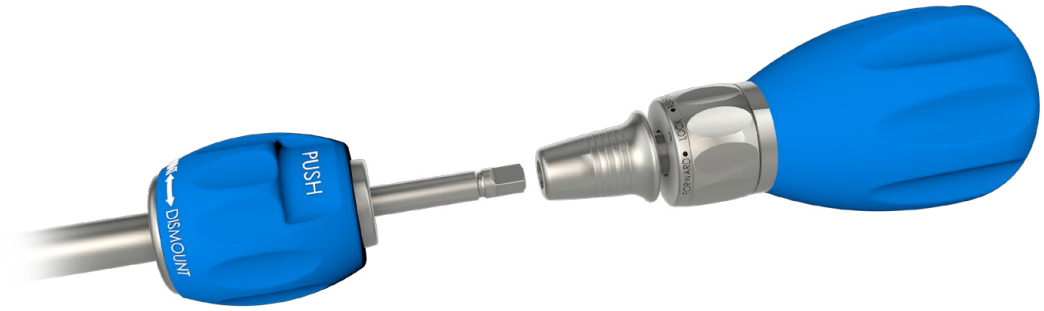

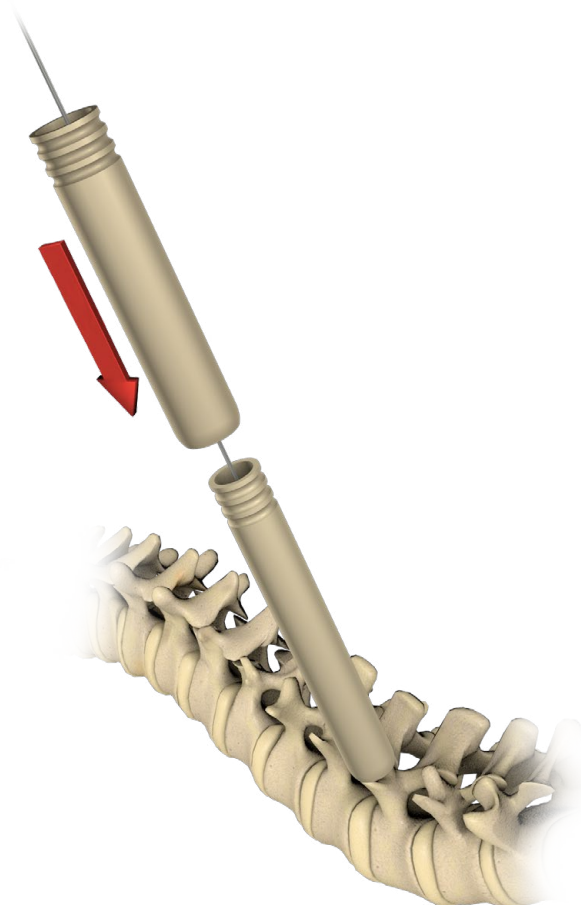
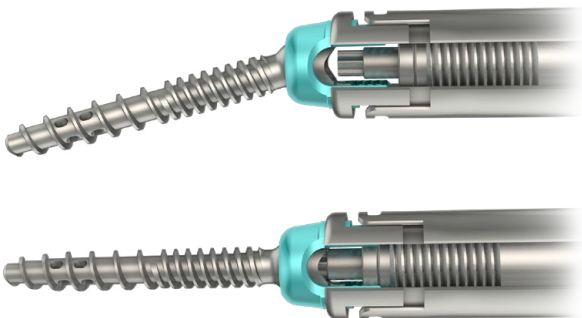
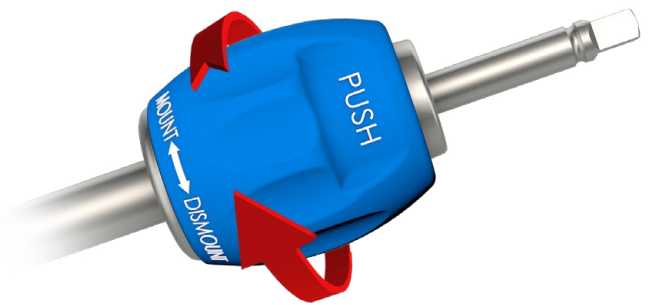

Then insert the wrench tip into the chosen transpedicular screw.

Turn the wrench knob clockwise to tighten the threaded outer sleeve of the wrench [40.8568.000] until the tip is fully seated in the bottom of the screw socket. The tightening direction is marked with an arrow and the word MOUNT. When tightening, with increasing resistance, the wrench knob will automatically move to the position that activates the mechanism preventing the screw from loosening.



To insert screws, replace protective guide II [40.8563.000] with protective guide III [40.8564.000].

	40.8563.000
	40.8564.000

After replacing the protective guides, the pedicle screw can be inserted. There are 10 guide sleeves in the instrument set allowing for simultaneous stabilization of 5 levels of the spine.



The screw insertion should be controlled in two planes using a fluoroscope.



It should be remembered that the correct screws positioning is achieved by screwing in the screws and not by screwing them out.

Backing the screw out may result in the loss of a stable anchoring and the need for use of a larger diameter screw.

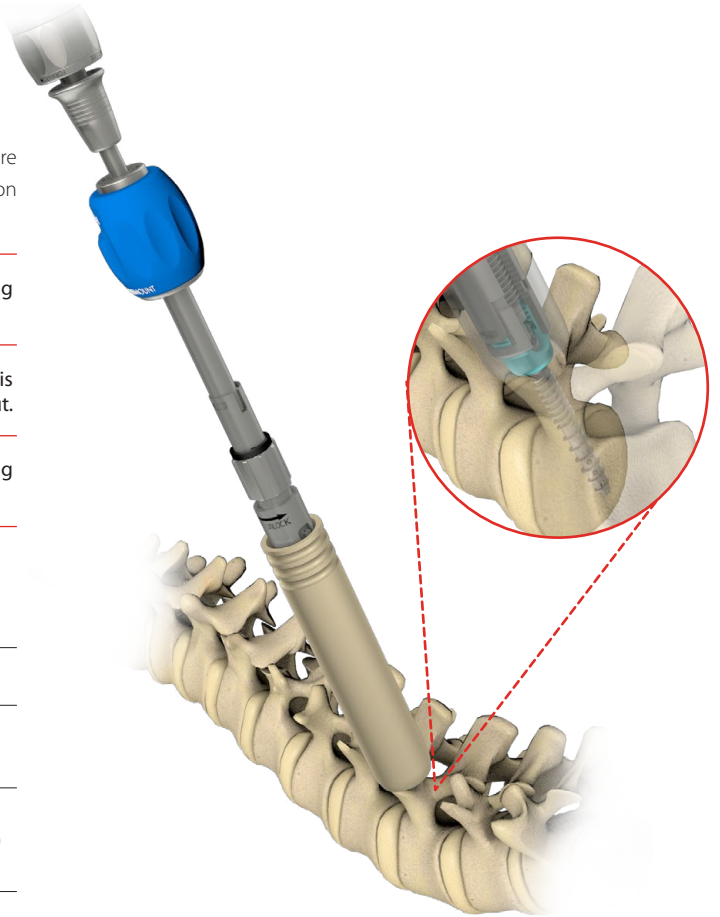
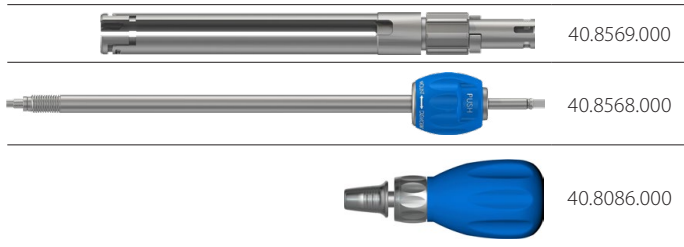

When implanting the screw, do not hold the oval knob of the wrench, as this will disengage the safety mechanism.

If there is a need to use the other hand to hold the wrench, hold the part of the sleeve below the oval knob.

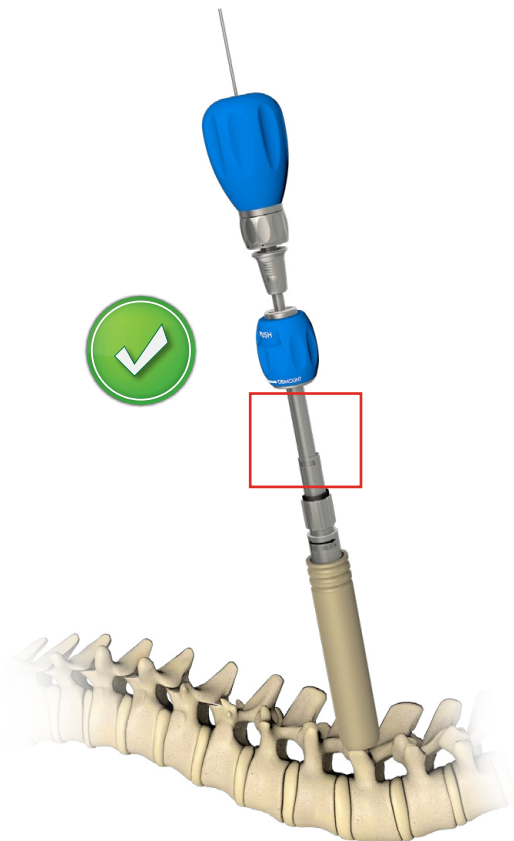
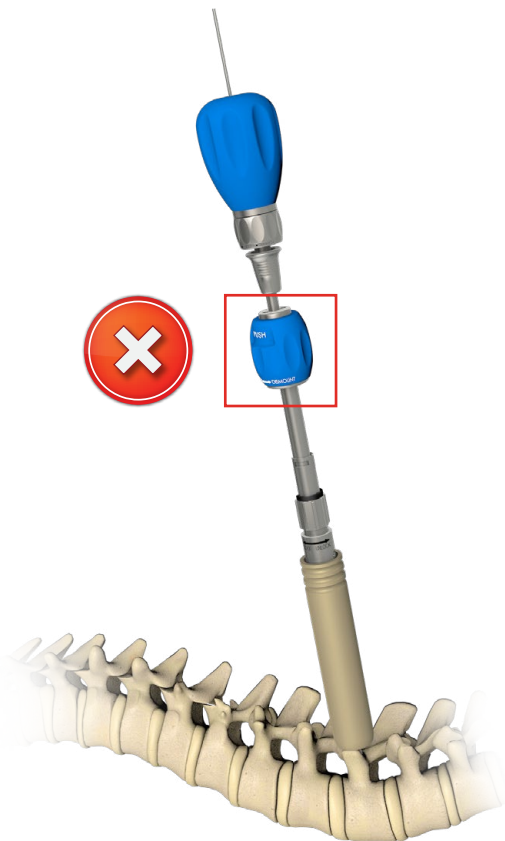



To remove the wrench **[40.8568.000]** from the screw, loosen the threaded sleeve of the wrench by turning the oval knob counterclockwise (*the direction is marked with an arrow and the word DISMOUNT*). When loosening, the wrench locking mechanism disengages automatically.

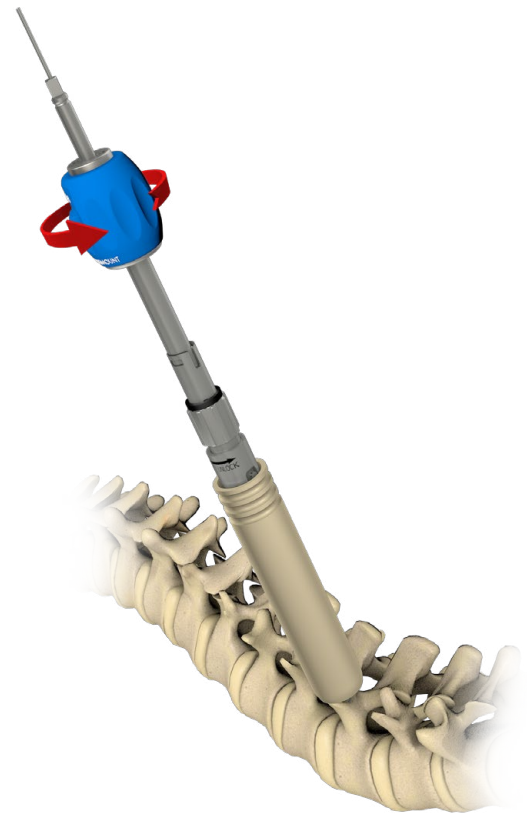

#### 4.6.6. GUIDE ROD REMOVAL

After screw insertion, remove the guide rod 1.5/500 **[40.8559.000]** and the protective guide III **[40.8564.000]**, leaving the guide sleeve **[40.8569.000]** attached on the screw.

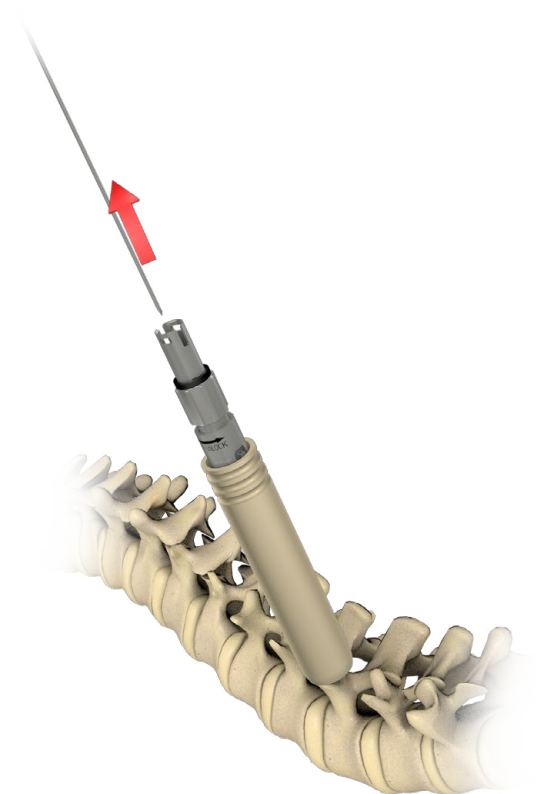
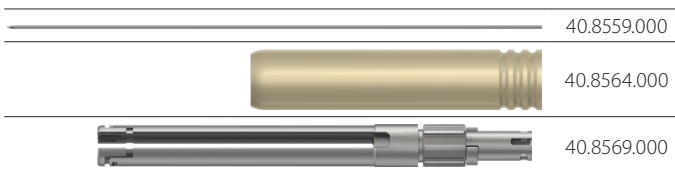

Repeat the steps described in chapter 4.6 to enter the required number of screws.

## 4.7. CEMENT AUGMENTATION OF SCREWS (OPTIONAL)

### 4.7.1. USE OF CANNULA FOR BONE CEMENT

If a bone cement is to be injected into the vertebral body, a cannula for bone cement [40.8591.000] (not included in the standard instrument set.), through which the cement will be injected, should be attached to the implanted screw (before removing the guide wire). To do this, hold the flattened tip of the cannula and insert the other end of the cannula, using the guide rod and guide sleeve, into the screw head and then tightened it up (clockwise rotation).

In order to ensure the reliable connection, for final tightening use the wrench [40.8580.000].

Remove the guide rod.

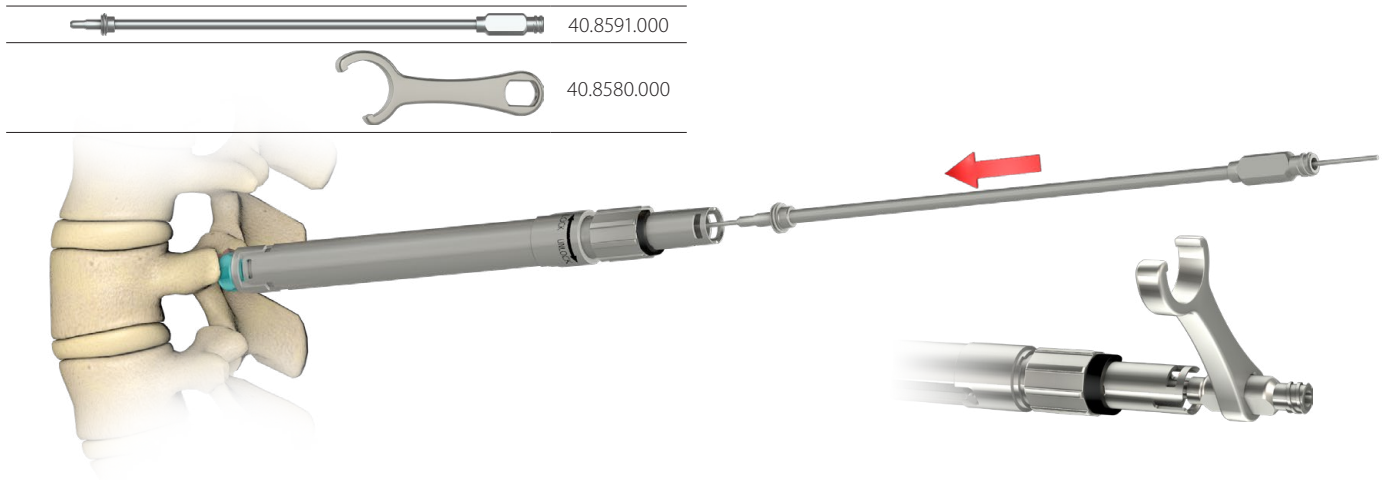

If the guide rod was removed before insertion of the cannula for bone cement, to confirm the coaxiality of the holes in the cannula and the screw, use the alignment trial for cannula [40.8592.000] (not included in the standard instrument set). The trial should be inserted into the cannula until stop.



If the alignment trial cannot be fully inserted, the cannula for bone cement has not been properly connected to the screw. In such situation, loosen slightly the cannula in the screw (counterclockwise rotation), reposition the screw head using the guide sleeve and then push the trial to the end and tighten fully the cannula.



Should the screw been inserted so deep that the screw head was immobilized by the neighbouring bone, it may be necessary to slightly back out the screw to allow the head to be mobilized and the cannula to be properly inserted.



Incorrect connection of the cannula with the screw can cause cement leakage at the connection point.

Before cement injection, all cannulas for bone cement should be attached to the screws.

#### 4.7.2. CEMENT PREPARATION AND INJECTION

For cement preparation, refer to the Instructions for Use for bone cement and cement mixing/delivery device system. The cannula for bone cement is equipped with a standardized Luer Lock thread, enabling a tight connection with the cement mixing/delivery device.



The volume of cement in the cannula [40.8591.000] is 1.17 ml.



Mix the cement as instructed and suck it into the cement mixing/delivery device. Before injecting, wait until the cement reaches the right viscosity.



Fluoroscopy should be used throughout the cement injection procedure to control the cement flow.

When using cement to augment multiple screws and levels, attention must be paid not to exceed the working time of the cement prior to completion of cement delivery through the screws. When the cement working time is close to completion, a new cement package should be used.



The cannula for bone cement as well as the mixing/delivery device are designed for use with one package of bone cement only. If a second package of cement is needed, use a new cannula and mixing/delivery device.

Do not attempt to force the injection of cement if excessive resistance is felt. Always determine the cause of the resistance and take appropriate action. If the cement is seen outside of the vertebral body or in the circulatory system during the procedure, immediately stop injecting the cement.

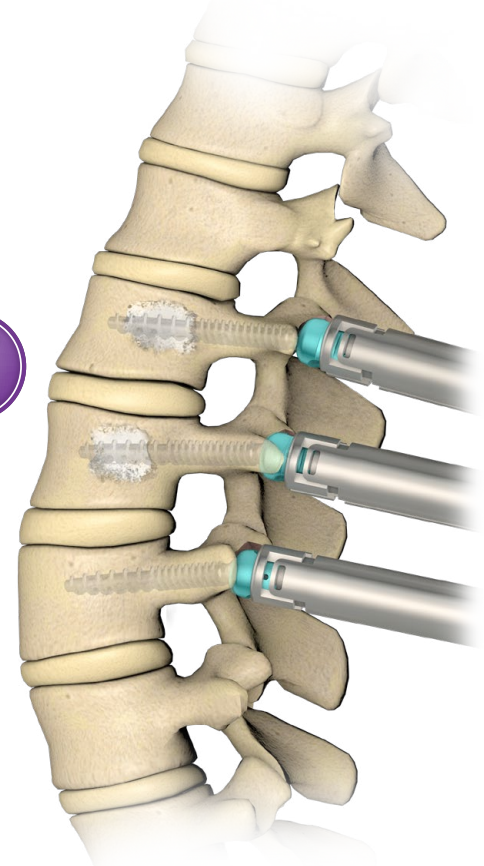

#### 4.7.3. REMOVAL OF THE CANNULA FOR BONE CEMENT

After cementing, unscrew the cannula from the screw. Hold the guide sleeve [40.8569.000] with the other hand to counteract the removal process.

It is important, that after cementing and before removing the cannula from the screw, to make sure that the cement flow is stopped by backing out the cement feeder slightly.



It is critical that no torsion movement should be applied to the screw after injecting the cement in order to avoid breaking the cement bridges between screw and bone.

The cannula for bone cement and cement mixing/delivery device are disposable equipment and must be discarded after cementing.

### 4.8. LENGTH MEASUREMENT, USE WITH THE APPLICATOR, SHAPING AND INSTALLATION OF THE ROD

#### 4.8.1. USE OF GAUGE [40.8570.000]

The measurement is made by placing the measuring levers of gauge [40.8570.000] in the guide sleeves [40.8569.000], and then reading the values from the measuring scale. The value on the scale indicates the length of the rod to be used for stabilization.



Only the accurate seating of the levers of the gauge at the bottom of the screw guarantees the correct measurement.

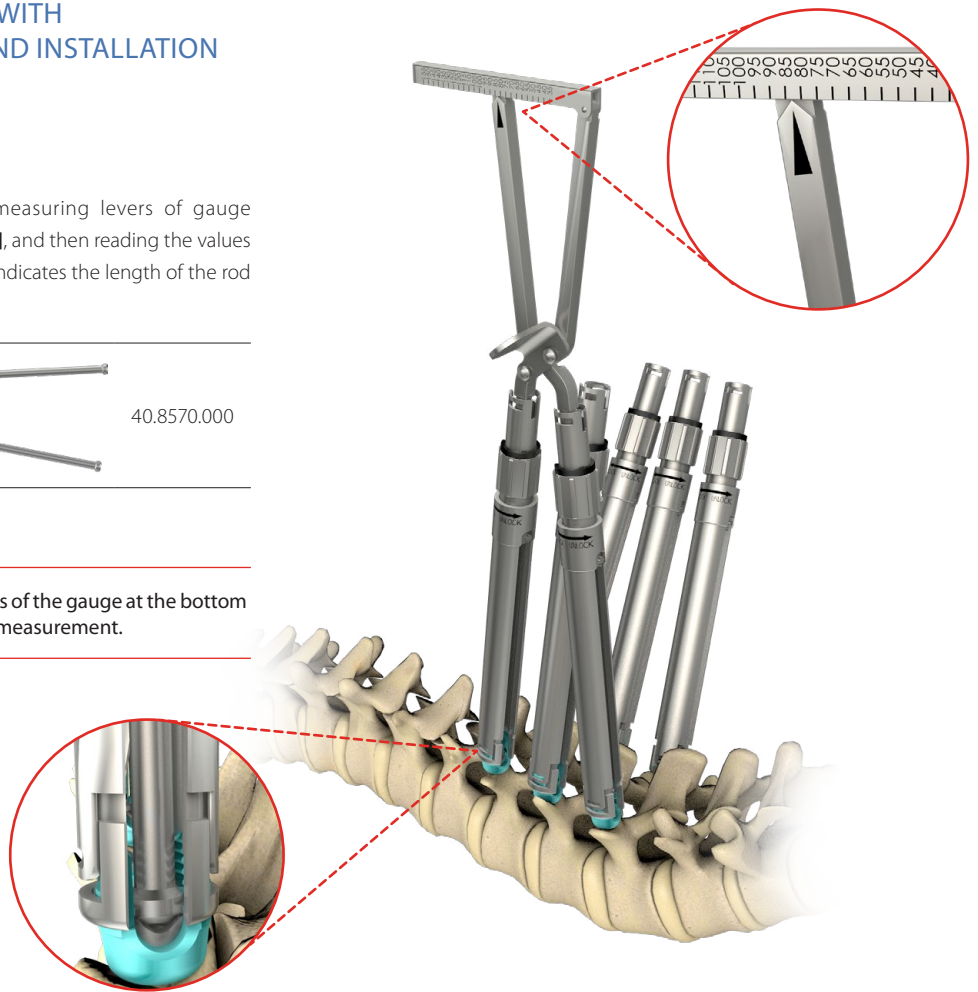

Before placing the gauge [40.8570.000] on the stand, set the scale along the measuring lever. To do this, unlock the measuring levers, fold the scale and relock the levers.



#### 4.8.2. USE OF ROD TRIAL 6/300 [40.5246.300]

Applying the rod trial 6/300 [40.5246.300] to the skin surface next to the guide sleeves [40.8569.000] and read from the scale the value corresponding to the external dimension between the sleeves. The value on the scale indicates the length of the rod to be used for stabilization.



For accurate measurement, the guide sleeves [40.8569.000] should be parallel to each other.

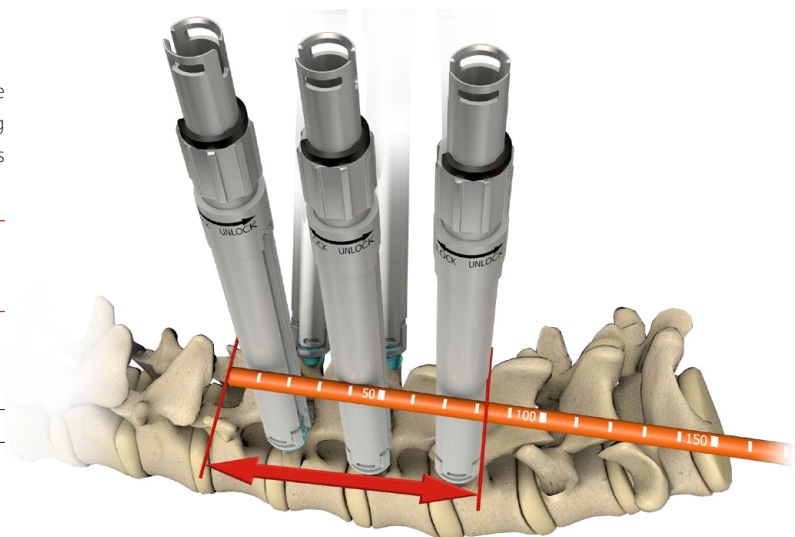

4.8.3. USE OF THE ROD WITH APPLICATOR AND ITS SHAPING

Two angular versions of the applicator are available: curved [40.8571.000] and straight [40.8572.000]. To attach the rod to the applicator, loosen the locking pin by turning the applicator wheel and place the spinal rod in the applicator socket with the drill hole facing up as shown in the picture. Immobilize the rod by tightening the locking pin.

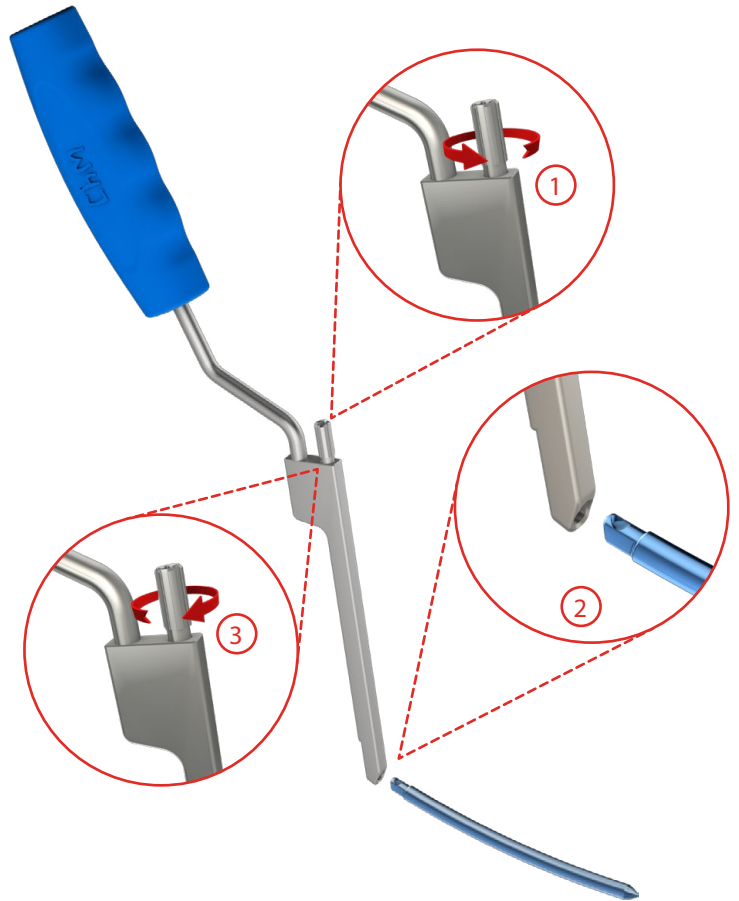
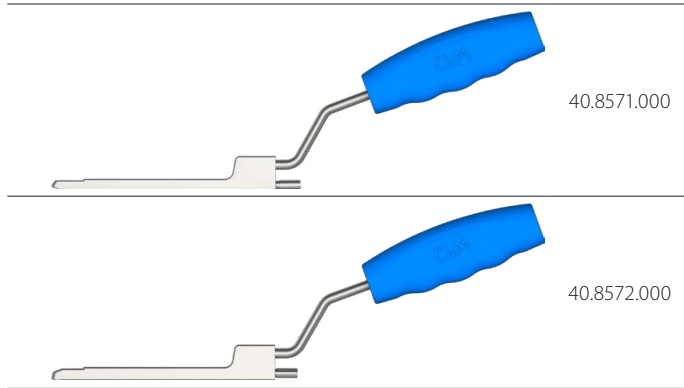

Two types of rods are available in the **CHARSPINE2 MIS** system: straight and pre-bent. If the rod needs to be bent to obtain the planned curvature of the spine (e.g. *lordosis* or *kyphosis*), the rod should be profiled accordingly, with the use of adjustable rod bender [40.8074.000].

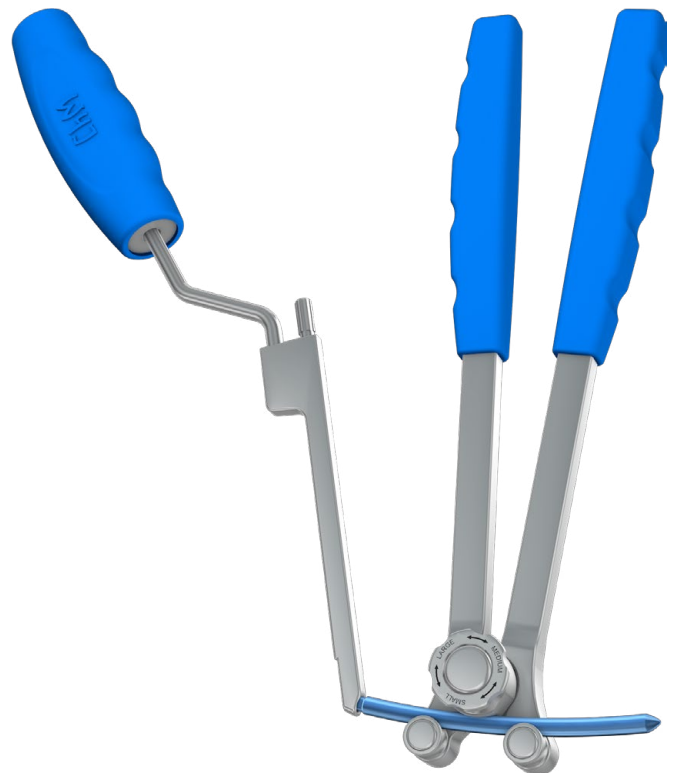
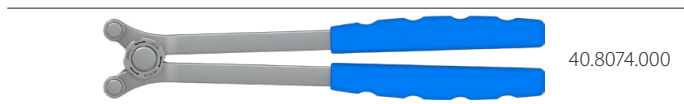

#### 4.8.4. ROD INSERTION

The rod insertion should proceed from the extreme screws (*in the rostral or caudal direction*). Insert the rod percutaneously through the longitudinal channels located in the guide sleeves **[40.8569.000]**. Make sure the rod is inserted into all the screws.



Verify the correct positioning of the rod with a fluoroscope.

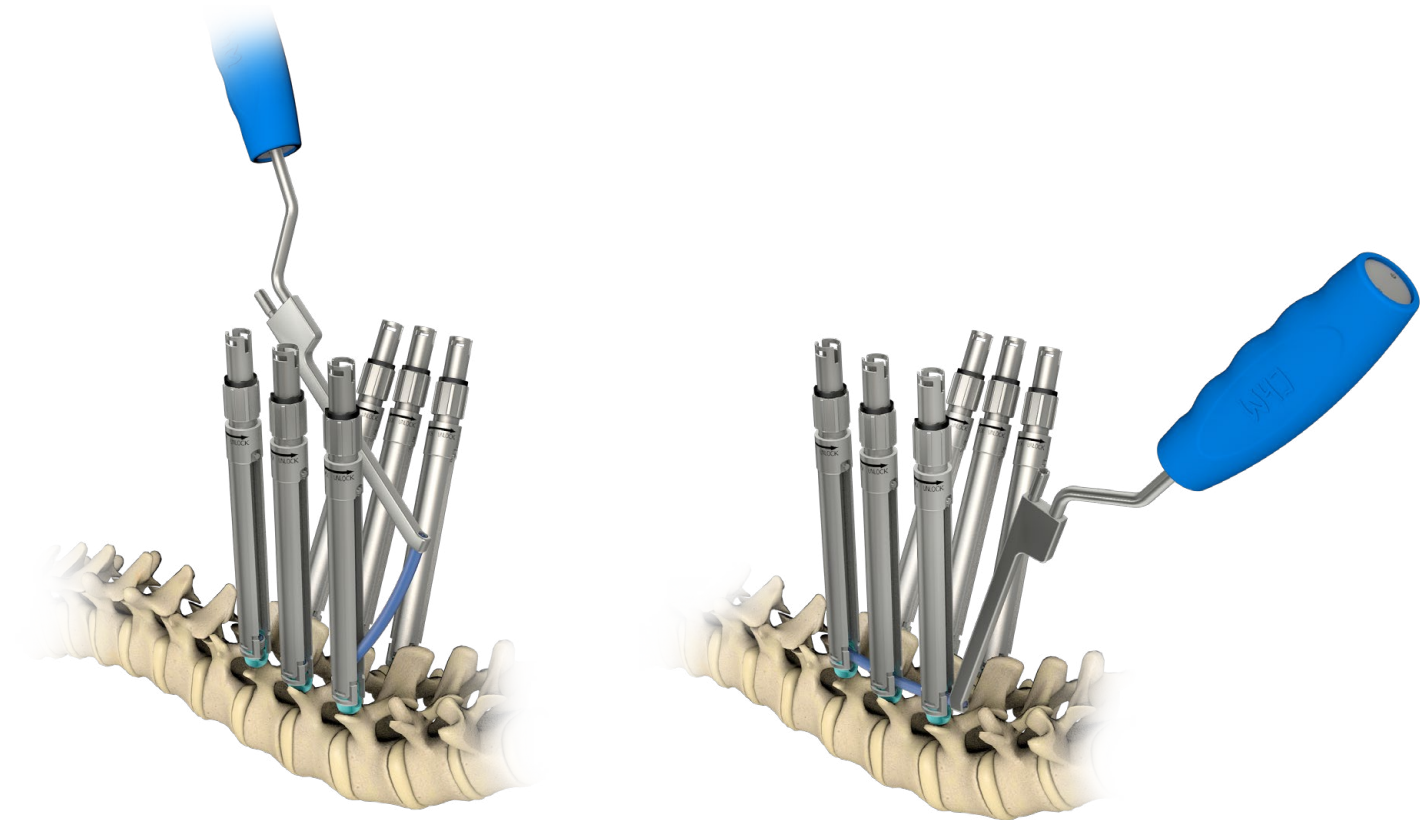

#### 4.9. ROD LOCKING, DISTRACTION, COMPRESSION, FINAL TIGHTENING

##### 4.9.1. ROD LOCKING

Lock the rod by insertion of the locking screw **[3.6160.000]** into the head of the transpedicular screw.

The locking screw can be attached to the screwdriver T30 tip **[40.8574.000]** only from the top of the screw (*the design of the locking screw socket prevents fixation in the other way*).

For easier identification, the top surface of the screw is colour-marked.

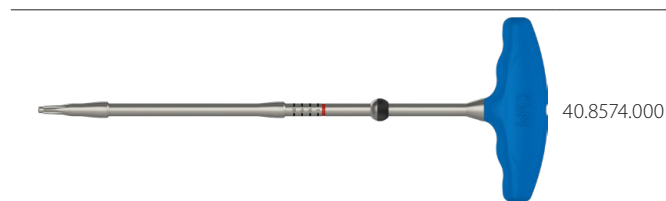

40.8574.000

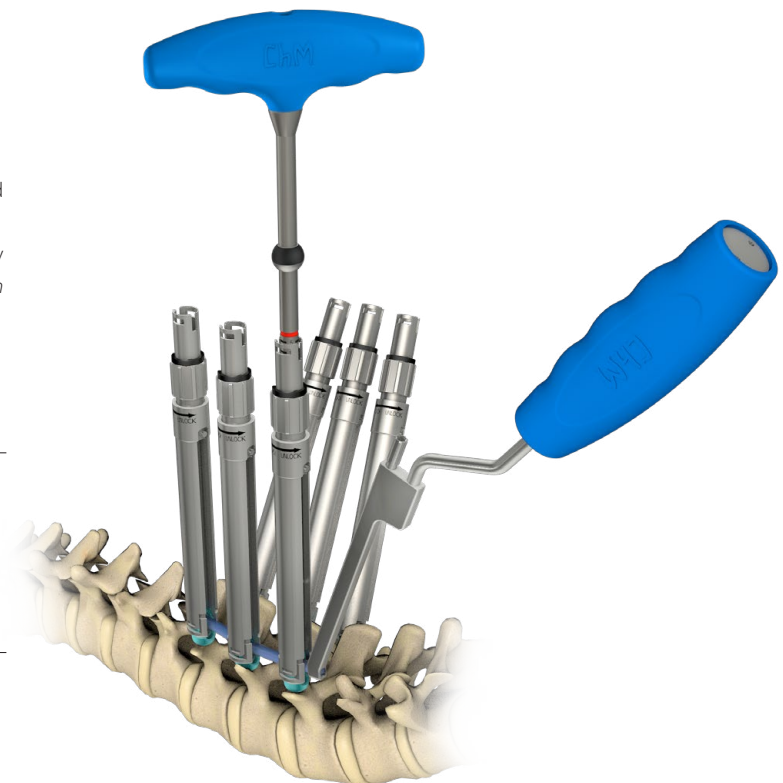

Attach a locking screw to the tip of the screwdriver T30 [40.8574.000], place in the cutout of the screw head and slightly tighten clockwise.



At this stage, the locking screw should only be slightly tightened, allowing the polyaxial screws to adapt to the shape of the rod.

Should it be difficult to press the rod to the bottom of the screw, use the rod impactor [40.8573.000] available in the instrument set.

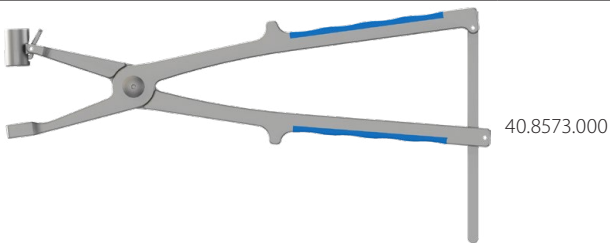

To do this, attach the snap sleeve of the impactor to the guide sleeve [40.8569.000].

Assure the notches in the guide sleeve are corresponding with protrusions in the snap sleeve. Install the snap sleeve until it clicks in the hole of the guide sleeve.

Then, place the arm with the ball socket on the ball located on the shaft of the screwdriver T30 [40.8574.000] and push the arms towards each other to position the rod at the bottom of the screw. Observe the location of the red mark on the screwdriver tip.

When the red marker is at the height of the edge of the guide sleeve, the locking screw contacts the upper surface of the screw head.

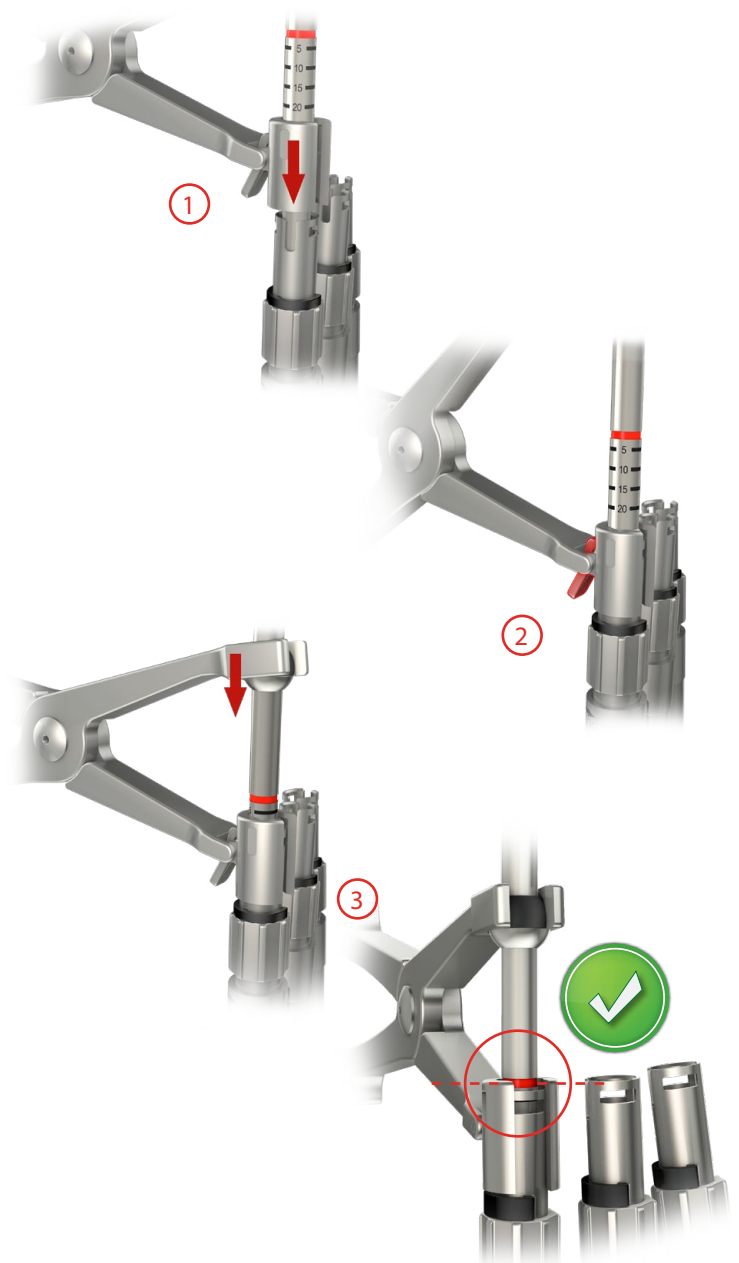



To pre-lock the screw, squeeze the arms of the rod impactor again while tightening up the locking screw.

Check the position of the red mark on the screwdriver tip.

When the marker penetrates about 5mm inside the guide sleeve, the locking screw is tightened up in the screw head.

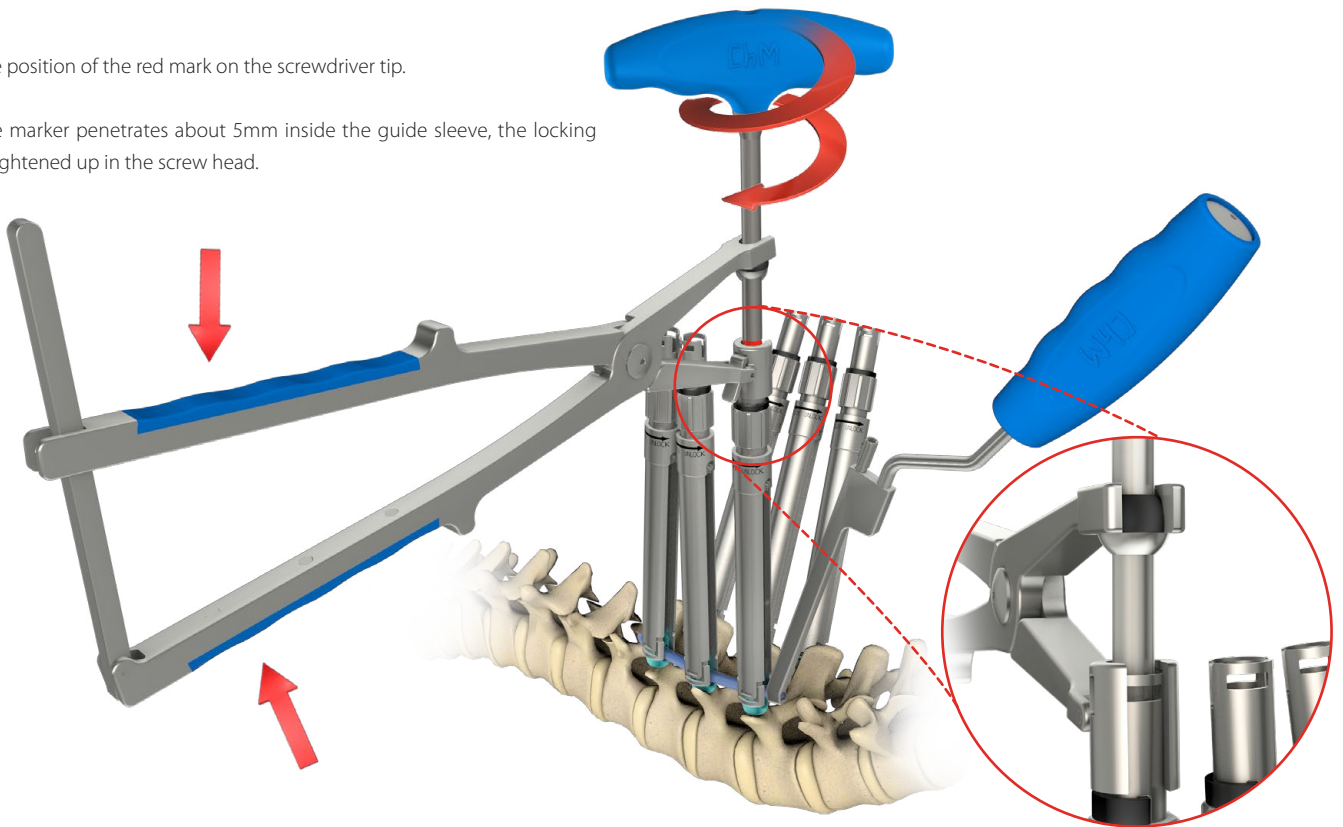

Should it be difficult to push the rod in and tighten the locking screw up, loosen slightly the locking screws in a row, allowing the head of the polyaxial screws to match the rod shape and facilitating tightening of the problematic locking screw.



Excessive distance between the rod and the screw head may result in excessive axial force acting on the screw and, consequently, pulling the screw out of the vertebral bone. Re-shaping of the rod should be considered.

After initial tightening, in order to remove the rod impactor [40.8573.000], unlock the toothed bar, extend the arms sufficiently so that it is possible to easily remove the arm with the ball socket and turn the entire instrument downwards. Turning the impactor downwards releases the snap and allow the device to be removed from the guide sleeve [40.8569.000]. If it is not possible to turn the impactor downwards, use the other hand and release the snap with a finger. Finally, remove the screwdriver T30 [40.8574.000].

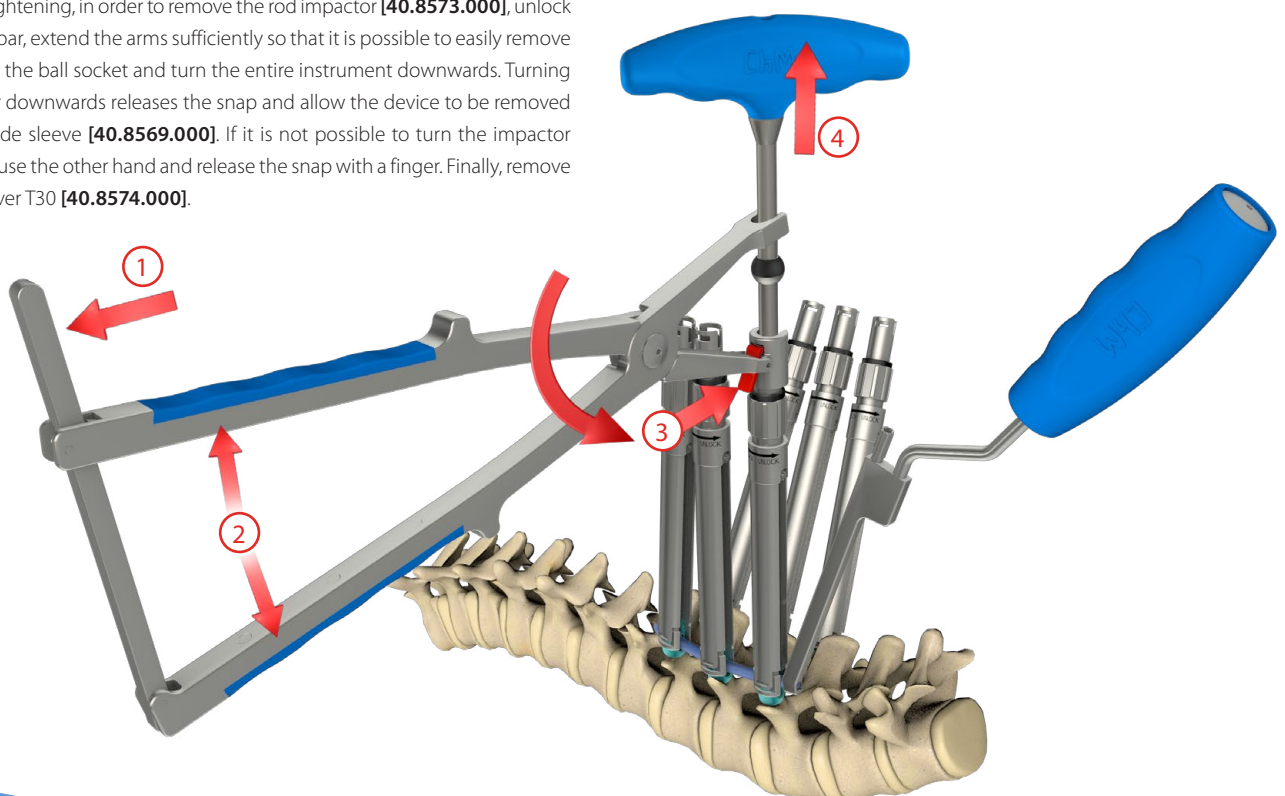



4.9.2. DISTRACTION, COMPRESSION

If distraction or compression of the intervertebral spaces is necessary, use parallel compression forceps [40.8576.000] or parallel distraction forceps [40.8577.000] that enable translations of the vertebrae. To do this, place guides II [40.8575.000] on the guide sleeves [40.8569.000] and then attach appropriate forceps

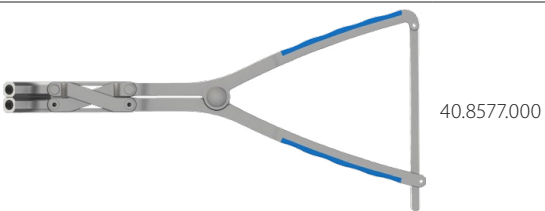
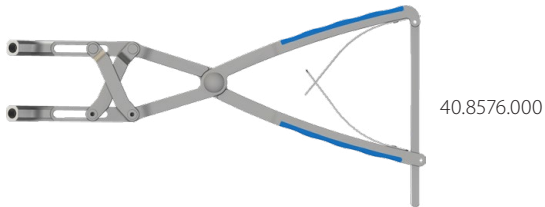
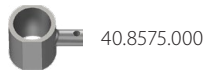

When distraction over a long distance is required (e.g. to decompress a broken vertebra), use the connector [40.8595.000] that is not included in the standard instrument set.



Place the reposition plate [40.8578.000] on the ends of the guide sleeves so that the largest hole in the plate is always used. Push the forceps levers toward each other to displace the vertebrae (distraction or compression depending on the forceps used).

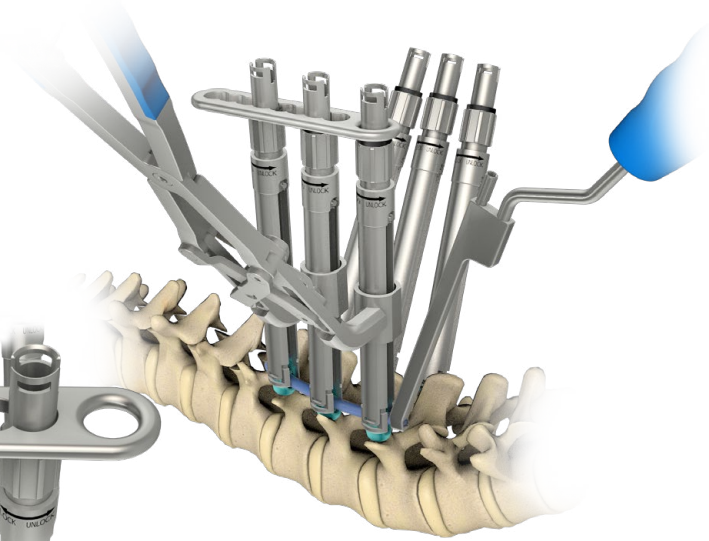
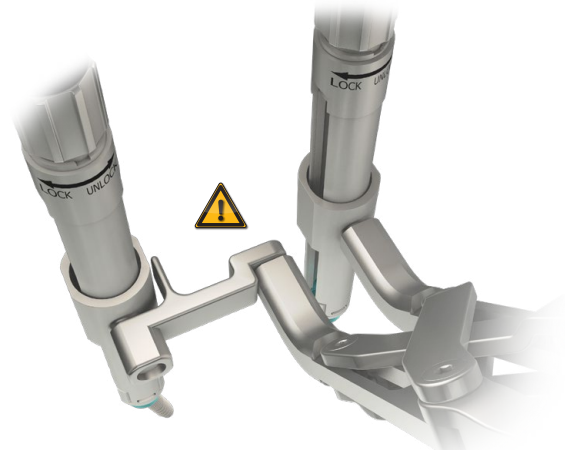
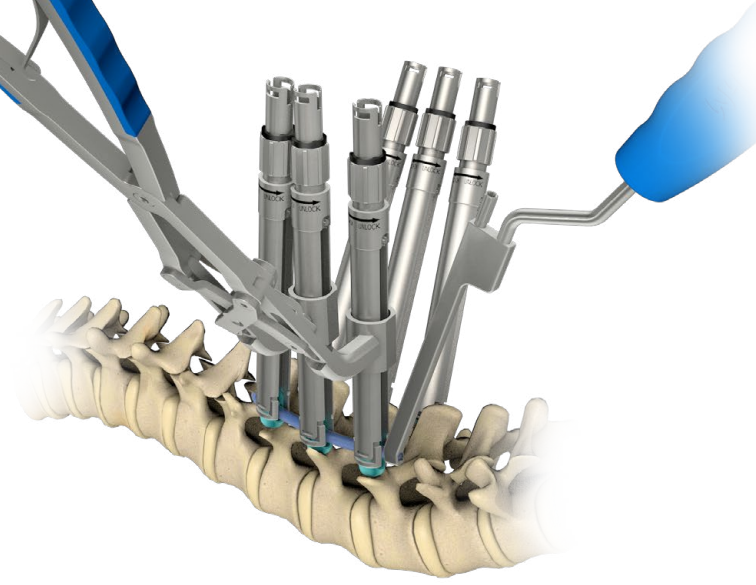
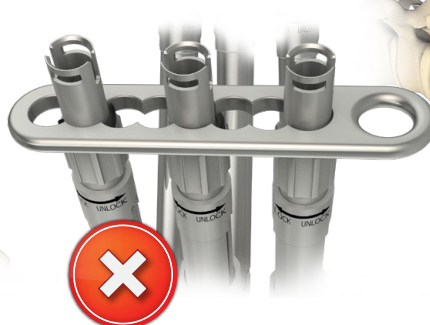
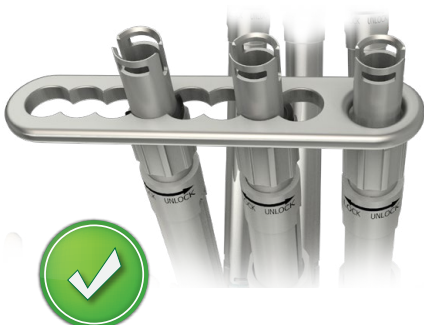

### 4.9.3. FINAL LOCKING

When the required position of the vertebrae is reached, tighten finally the locking screws using T-type torque handle 12Nm [40.8087.000] and screwdriver tip T30 [40.8084.000]. When the required torque of 12Nm is reached, the dynamometric mechanism signals it with an audible snap.

To eliminate the movements of rod-screws system while tightening the locking elements, use the counter wrench [40.8579.000] that is attached to the notches in the guide sleeve [40.8569.000].

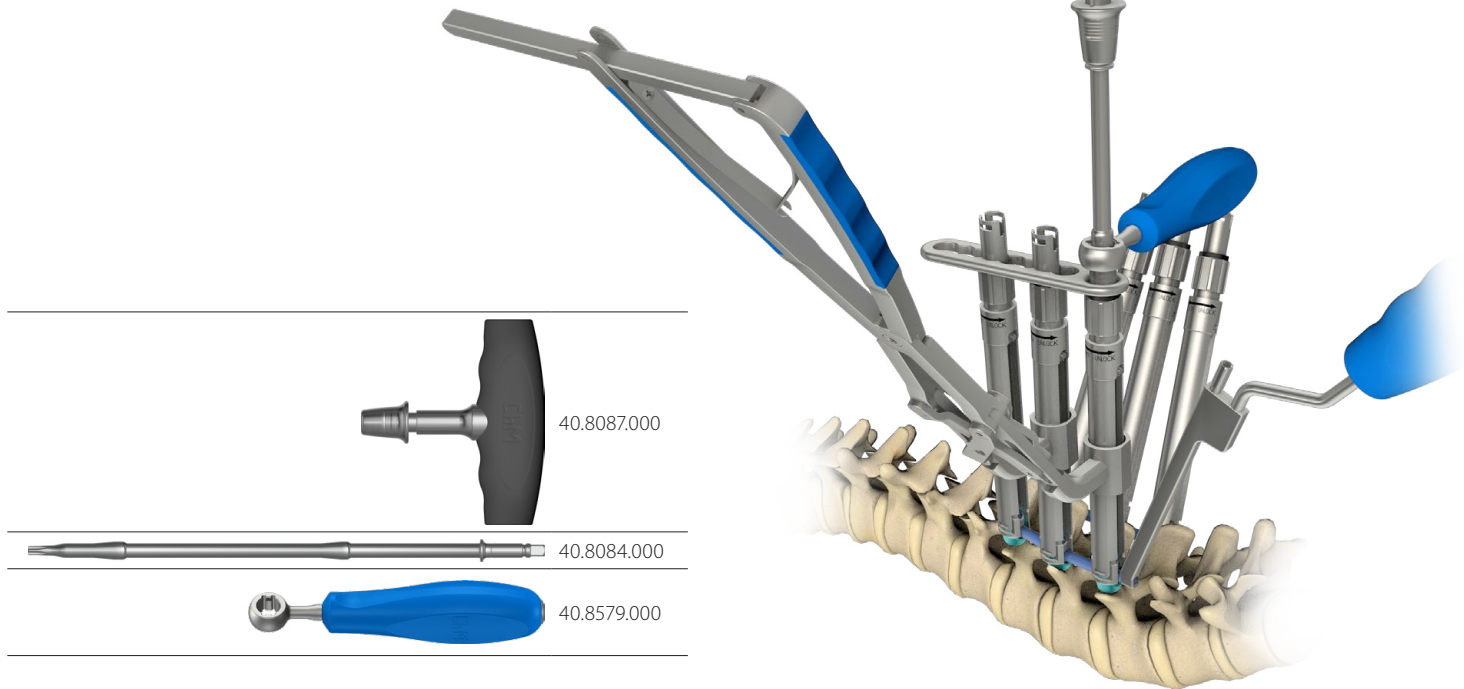

In order to maintain high safety and correct operation of the torque wrench [40.8087.000], follow the calibration deadline which is permanently marked on the instrument. The instrument calibration is performed by the manufacturer - ChM sp. z o.o.

If it is necessary to unscrew the locking screw, use screwdriver T30 [40.8111.000]. The tip of this screwdriver (*unlike 40.8574.000*) does not have a pilot. Such a design allows the instrument to be fully inserted in the locking screw socket reducing the risk of losing the locking screw inside the guide sleeve.



Having final tightened the locking screw and assured that the stabilization has been performed as planned, the applicator [40.8571.000] or [40.8572.000] and guide sleeves [40.8569.000] can be removed. To remove the guide sleeve, turn the sleeve wheel all the way in the UNLOCK direction, pull and remove the sleeve from the screw.

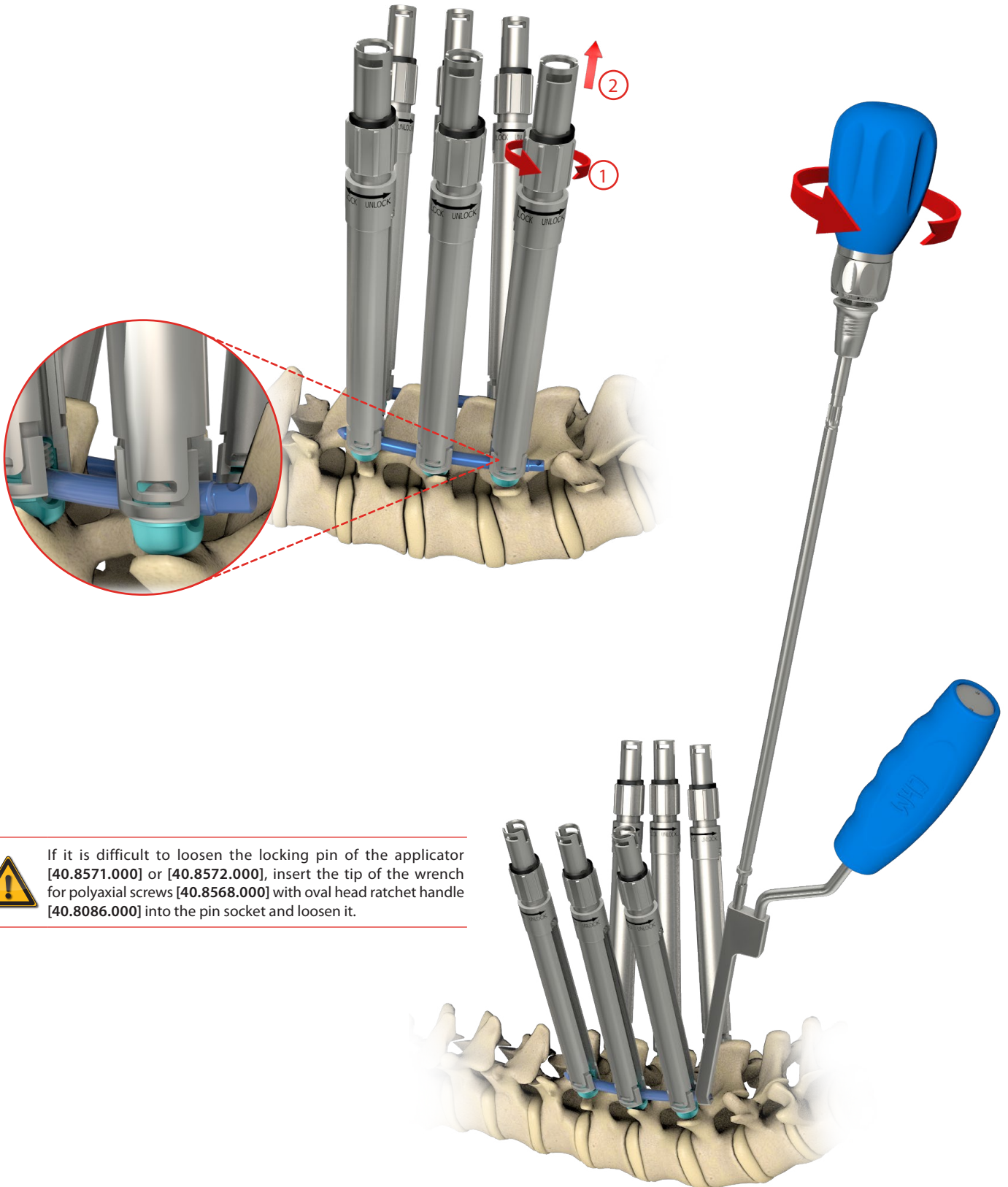

If it is difficult to loosen the locking pin of the applicator [40.8571.000] or [40.8572.000], insert the tip of the wrench for polyaxial screws [40.8568.000] with oval head ratchet handle [40.8086.000] into the pin socket and loosen it.



If it is difficult to loosen the sleeve wheel, use the wrench [40.8580.000].



40.8580.000

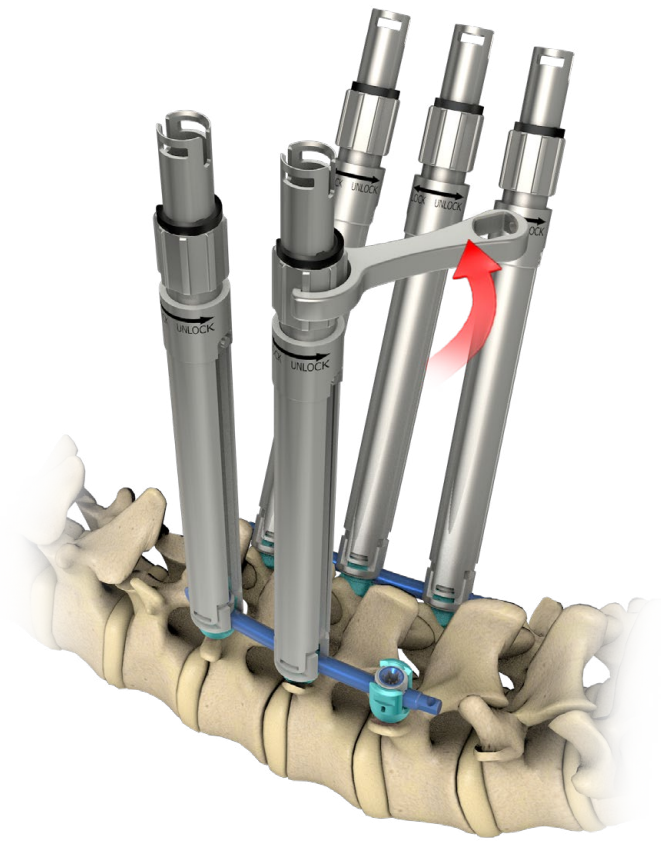

## 5. REVISION SURGERY

The design of the guide sleeves [40.8569.000] allows them to be re-attached to the already implanted screws.

To facilitate centering of the sleeve with the screw, use screwdriver tip T30 [40.8084.000] entered through the guide sleeve [40.8569.000] and then insert the tip into the socket of the implanted locking screw.



40.8569.000



40.8084.000



Then slide the sleeve onto the screw and follow the instructions in section 4.6.4. After mounting the sleeve, the screwdriver tip T30 [40.8084.000] can be removed.

If it is necessary to unscrew the locking screw, use screwdriver T30 [40.8111.000]. The tip of this screwdriver (*unlike 40.8574.000*) does not have a pilot. Such a design allows the instrument to be fully inserted in the locking screw socket reducing the risk of losing the locking screw inside the guide sleeve.



40.8111.000

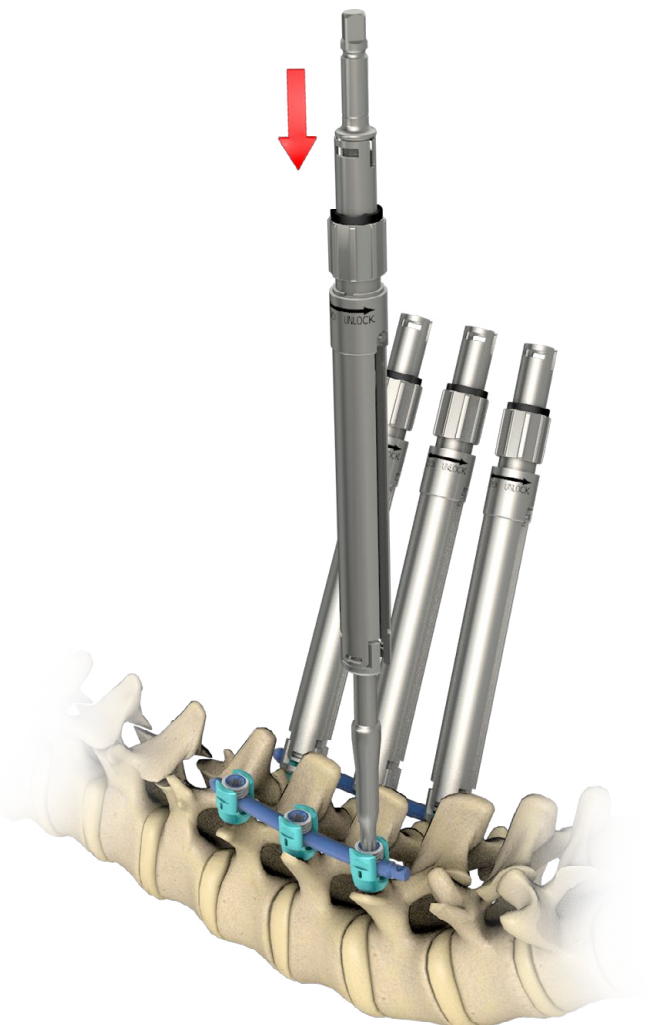



**ChM sp. z o.o.**

Lewickie 3b  
16-061 Juchnowiec Kościelny  
Polska

tel. +48 85 86 86 100

fax +48 85 86 86 101

chm@chm.eu

www.chm.eu



CE 0197