

U.S.T. SI

SACRO-ILIAC JOINT SCREW SYSTEM

A COMPLETE SYSTEM WITH DIFFERENT OPTIONS



Surgical Technique

Joint

Spine

Sports Med

INTRODUCTION

The M.U.S.T. Sacro Iliac Screws System [M.U.S.T. SI] is designed for the sacroiliac joint fusion in degenerative cases.

The M.U.S.T. SI screws are coated with porous and rough Hydroxyapatite and are designed with hollow-body and multiple fenestrated patterned shafts to promote arthrodesis.



- Hydroxyapatite rough plasma spray coating allows for biological fixation and leads to optimal arthrodesis
- “One-size-fits-all” washers with Favoured angles capable to accommodate extreme angulation and allow optimal compression
- Radial windowed slots along the screw’s body intended to optimize surrounding bone access to the bone substitute, allowing greater bone growth through the Screw
- Self-Tapping screws to facilitate screw insertion
- Long Pitch along with Dual Lead Thread for accelerated screw insertion and removal
- Cannulated shaft accepts Ø3.2mm Guide Wire for better bone purchase
- Tapered screw tip to aid in guidance through pilot hole
- Comprehensive range of lengths to accommodate patient anatomy

INDEX

1. INDICATIONS	4
2. CONTRAINDICATIONS	4
3. PREOPERATIVE PLANNING	4
4. SURGICAL STEPS	5
4.1 Guide Wire Insertion	5
4.2 Tissue Shield Placement	5
4.3 Screw Length Measurement	5
4.4 Drilling & Tapping	6
4.5 Screw Preparation	6
4.6 Screw Insertion	6
4.7 Washer Insertion	7
4.8 Implant Removal	8
5. IMPLANTS NOMENCLATURE	9

1. INDICATIONS

The M.U.S.T. SI Implant System is intended for sacroiliac joint fusion for skeletally mature patients suffering from sacroiliac joint disruptions, degenerative sacroiliitis and

degenerative sacro-iliac arthritis, secondary to pelvic disruption.

2. CONTRAINDICATIONS

- Deformities or anatomic variations that prevent or interfere with SI implant placement.
- Tumor involving sacral or iliac bone.
- Active infection at treatment site.
- Intolerance / Allergy to the materials used in the manufacture of this device
- Any active or suspected latent infection or marked local inflammation in or about the affected area
- Compromised vascularity that would inhibit adequate blood supply to the operative site
- Patients with, fever, tumors, elevated white blood count, mental illness and other medical conditions which would prohibit beneficial surgical outcome.
- Patients having inadequate tissue coverage over the operative site or inadequate bone stock or quality that cannot provide adequate support and/or fixation of the devices
- Implant utilization that would interfere with anatomical structures or physiological performance
- Any neuromuscular disorder which could create an unacceptable risk of fixation failure or complications in post-operative care.
- Other medical or surgical conditions which would preclude the potential benefit of surgery
- Reuse or multiple uses
- Rapid joint disease, bone absorption, osteopenia.

3. PREOPERATIVE PLANNING

The review of MRI and/or CT based imaging to template and determine the type/size of the implants to be used in order to correctly match the patient's anatomy is a critical step in pre-operative planning.

4. SURGICAL STEPS

4.1 GUIDE WIRE INSERTION

Insert the Wire Positioner through the incision until it gets in contact with the bone surface to treat (fig.1) and insert the Guide Wire through the Guided Sleeve into the bone.

Check the proper insertion and depth at the image intensifier.

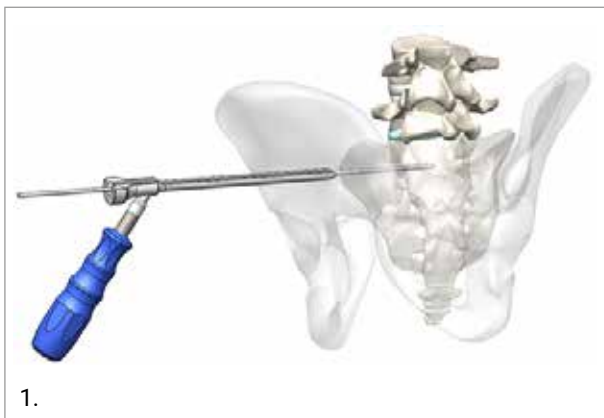

4.2 TISSUE SHIELD PLACEMENT

Remove the Wire Positioner and place the Dilator Tube(s) over the previously inserted Guide Wire (Fig.2-3).

Place the Retractor Tube over the Dilator Tube-Guide Wire previously placed and then remove the Dilator Tube(s) (Fig.4).

A dedicated Offset Handle can be specifically coupled with the Retractor for better handling

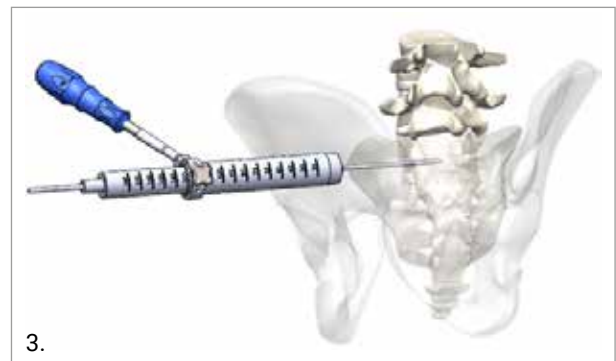
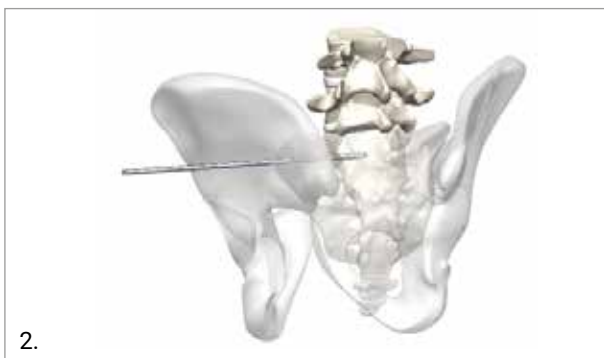

4.3 SCREW LENGTH MEASUREMENT

Slide the Screw Depth Gauge through the Guide Wire down to the bone.

NOTE: When using the 305mm guide wire the screw length measurement is taken from the end of the guide wire (fig.5A); for the 450mm Guide Wire the proper screw length measurement is taken from the corresponding black laser marking on the wire(fig.5B).

NOTE: Ensure that the measuring gauge is placed against the cortex for accurate screw length measurement.

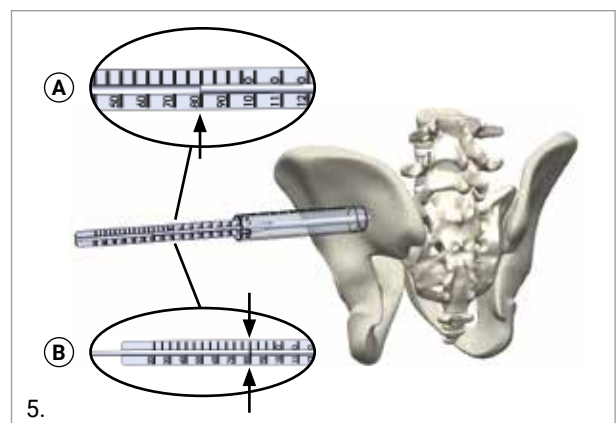

4.4 DRILLING & TAPPING

If hard bone is encountered, it may be useful to drill and/or tap prior to screw insertion.

Slide the Drill Bit over the Guide Wire and through the previously set retractor (Fig. 6).

Slide the Tap over the Guide Wire (and through the Tap Sleeve) down to the bone. Tap to the desired depth noting the calibrations on the Tap against the back of the Tap Sleeve (Fig. 7).

NOTE: When both the Tap and Tap Sleeve are flush to the bone cortex the scale reading on the Tap is initially set to "0".



6.

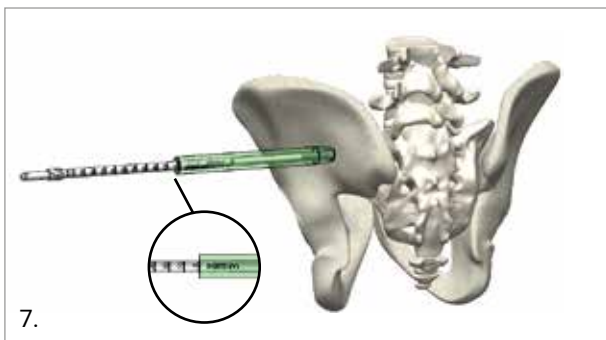

7.

NOTE: Please note that the Tap diameters are 0.5 mm undersized.

4.5 SCREW PREPARATION

Select the M.U.S.T. SI screw with the appropriate length.

Prepare the Screwdriver for the screw insertion by pulling down the proximal wheel in order to extract the distal threaded tip (Fig.8).

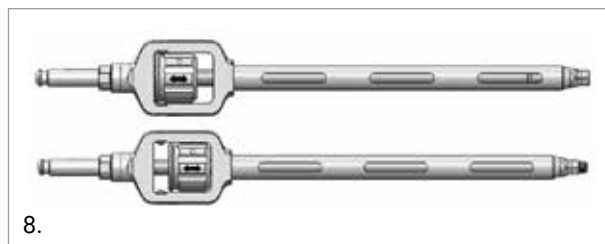

8.

Insert the Screwdriver threaded tip into the screw head and lock it by clock-wise tightening the proximal wheel until a mechanical stop is achieved (fig.9).

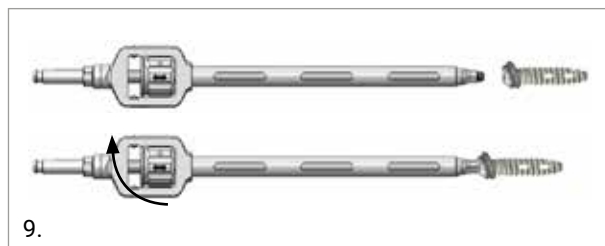

9.

4.6 SCREW INSERTION

Insert the M.U.S.T. SI screw through the Retractor and Insert it over the Guide Wire (fig.10); screw until mechanical stop is reached and the optimal compression is achieved (fig.11).

NOTE: Washer may be pre-assembled as per the steps described in chapter 4.7

To release the Screwdriver, turn the proximal wheel counter-clockwise to release the screw head and pull it to complete disengagement.

Obtain final radiographic images to confirm screw placement / fracture reduction.

Multiple screw insertion can be achieved by repeating all the above reported steps.

CAUTION

When placing multiple screws, the size of concomitant Washers must be evaluated in order to avoid their overlap in situ.

Wound closure follows standard technique.

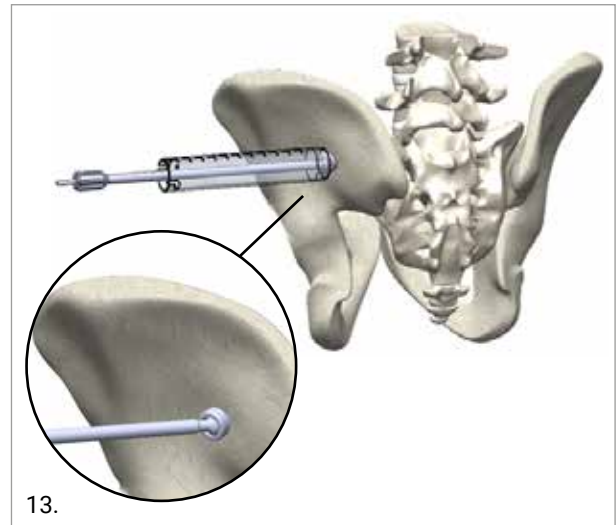
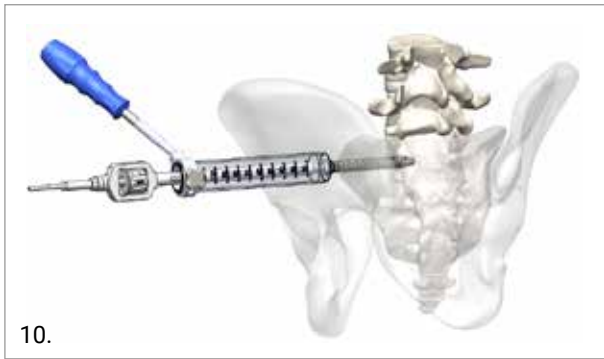

Load the Washer from the distal tip of the screw (Fig 14A) into a preliminary positioning (fig 14B); place the screw-washer assembly onto the washer clamp and compress it (Fig 14C) until an audible sound confirms the proper assembly of the washer onto the screw head.

NOTE: Once assembled with the steps mentioned above, the Washer is inseparably connected with the screw.

4.7 WASHER INSERTION

If desired, Washers may be preassembled along with the screws prior to screw insertion into the bone.

Standard Washers can help reaching up to typical angles while Favoured Angle Washers may accommodate extreme angulation (see following figure for details).

Washers may improve the load distribution and prevent screws from sinking into osteoporotic bone.

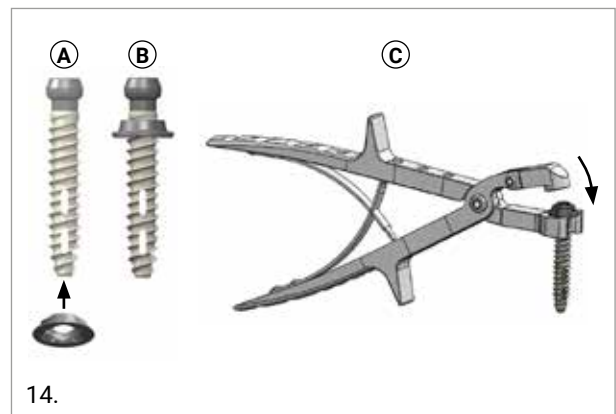
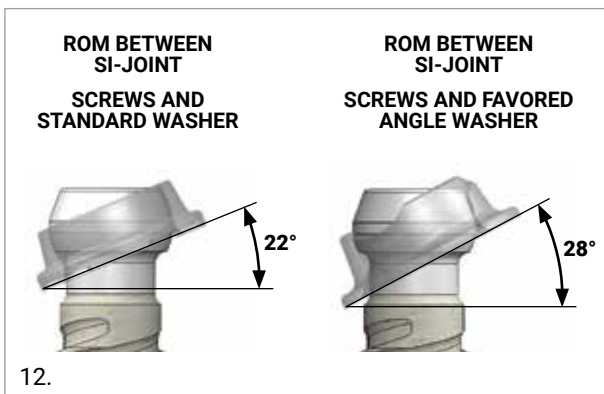

WARNING

The Washer must be correctly assembled to the screw. WRONG assembly is shown in the following picture

Insert the Washer Trial through the Retractor Tube and insert it over the Guide Wire in order to load the washer of the proper size (fig.9).



NOTE: The Washer Clamp provides self-aligning plates to hold and mount the Washer in a proper way; subsequent steps to adjust the Washer profile may be needed to provide a final appropriate assembly.

4.8 IMPLANT REMOVAL

Implant removal can be performed by simply coupling the Screwdriver Hex tip to the Screw Head and applying counter-clock wise rotation. Enhanced implant removal could be provided by sliding back the threaded tip of the Screwdriver (previously shown in Fig.8-9).

If necessary, as in the case of screw rupture or screw bone strip, a screw extractor can be used to retract the placed screw (Fig.16).



WARNING

As the Screw Extractor generates irreversible screw damage, a new screw must be used afterwards.

5. IMPLANTS NOMENCLATURE

SI-JOINT SCREWS TITANIUM HYDROXYAPATITE COATED



SIZE [Ø x L] [mm x mm]	REFERENCE NUMBER	SIZE [Ø x L] [mm x mm]	REFERENCE NUMBER	SIZE [Ø x L] [mm x mm]	REFERENCE NUMBER
8x25	03.65.501	9x25	03.65.601	10x25	03.65.701
8x30	03.65.502	9x30	03.65.602	10x30	03.65.702
8x35	03.65.503	9x35	03.65.603	10x35	03.65.703
8x40	03.65.504	9x40	03.65.604	10x40	03.65.704
8x45	03.65.505	9x45	03.65.605	10x45	03.65.705
8x50	03.65.506	9x50	03.65.606	10x50	03.65.706
8x55	03.65.507	9x55	03.65.607	10x55	03.65.707
8x60	03.65.508	9x60	03.65.608	10x60	03.65.708
8x65	03.65.509	9x65	03.65.609	10x65	03.65.709
8x70	03.65.510	9x70	03.65.610	10x70	03.65.710
8x75	03.65.511	9x75	03.65.611	10x75	03.65.711
8x80	03.65.512	9x80	03.65.612	10x80	03.65.712

TITANIUM WASHER - STANDARD



SIZE [mm]	REFERENCE
Ø13	03.65.901
Ø15	03.65.902
Ø17	03.65.903
Ø20	03.65.904

TITANIUM WASHER - FAVORED ANGLE



SIZE [mm]	REFERENCE
Ø15	03.65.912
Ø17	03.65.913
Ø20	03.65.914

Part numbers subject to change.

NOTE FOR STERILISATION

The instrumentation is not sterile upon delivery. It must be cleaned before use and sterilised in an autoclave in accordance with the regulations of the country, EU directives where applicable and following the instructions for use of the autoclave manufacturer. For detailed instructions please refer to the document "Recommendations for cleaning decontamination and sterilisation of Medacta International orthopaedic devices" available at www.medacta.com.



**REDEFINING BETTER
IN ORTHOPAEDICS
AND NEUROSURGERY**

MEDACTA.COM



Medacta International SA
Strada Regina - 6874 Castel San Pietro - Switzerland
Phone +41 91 696 60 60 - Fax +41 91 696 60 66
info@medacta.ch

Find your local dealer at: medacta.com/locations

All trademarks and registered trademarks are the property of their respective owners.

M.U.S.T. SI
Surgical Technique

ref: 99.46SI.12
rev. 00

Last update: April 2018
CE 0476