

ISOBAR™ TTL

Module In

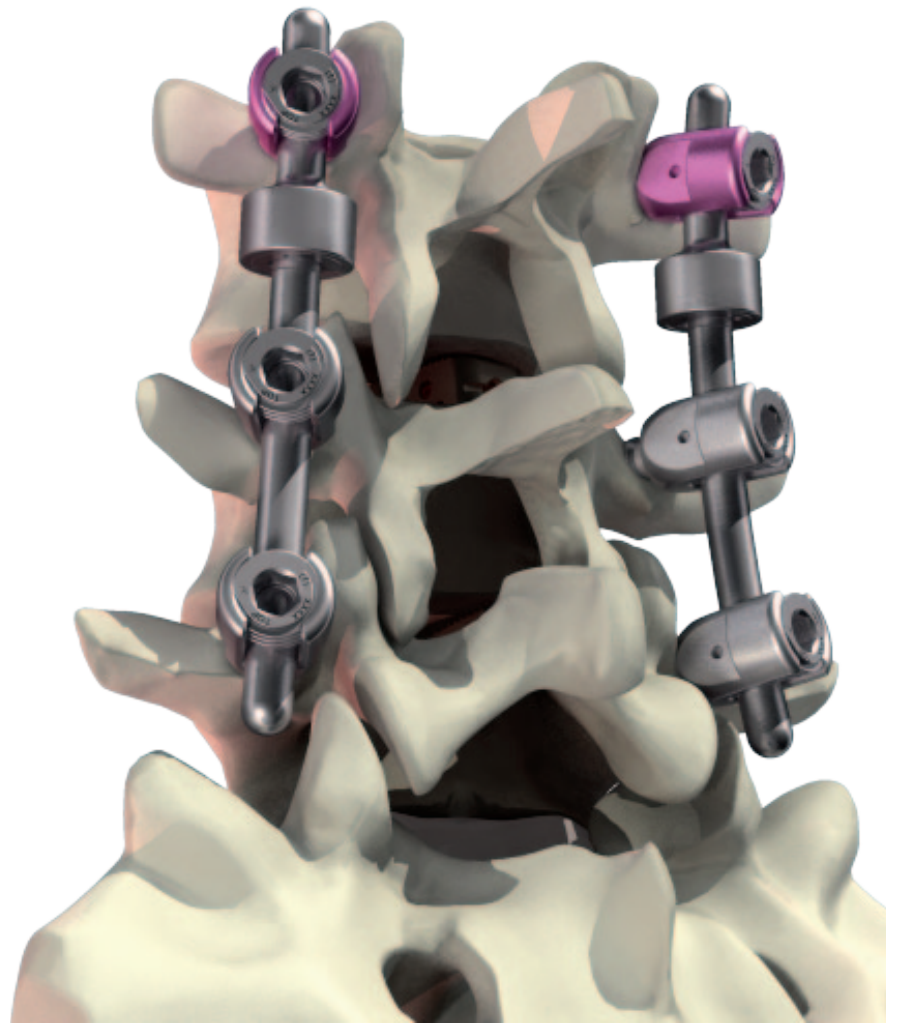

**DEGENERATIVE MODULE WITH TOP-LOADING
INNER SET SCREW**

SURGICAL TECHNIQUE GUIDE

Scient'x® α Alphatec Spine®
Solutions for the Aging Spine®

To facilitate Posterior lumbar fusion.

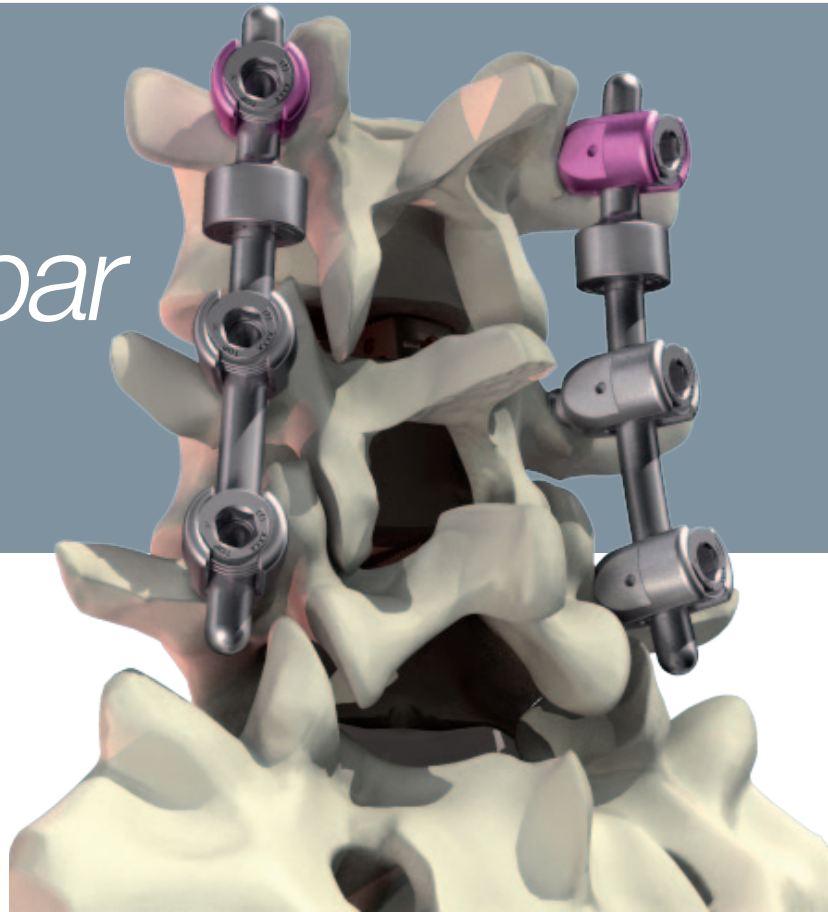

The Isobar™ TTL Module In provides a low profile top loading solution for posterior lumbar fusion

Buttress threaded inner nut

- > Provides strong axial resistance
- > Minimizes splaying of the screw head
- > Allows more tolerance to cross-threading and thus minimizes the risk of damaging the thread
- > Reduces profile of the screw head

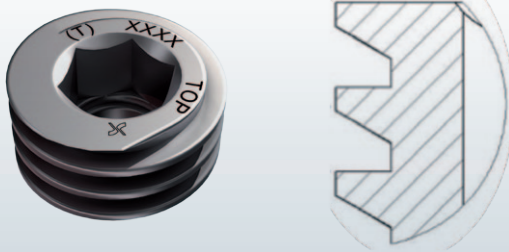

Low profile top-loading design

- > Polyaxial (up to 42°) or monoaxial
- > Provides easier and in-line fixation
- > Fits to all patients' anatomy & respects the surrounding tissues

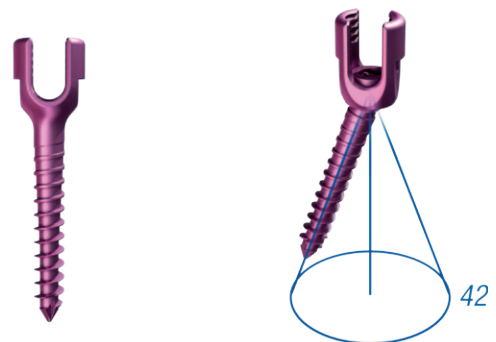

Common screw features

- > Color coded according to diameters for faster implant identification
- > Self-tapping for easier implant insertion
- > Cylindrico-conical bone thread for cancellous to cortical thread transition
- > Titanium alloy TA6V for ideal strength and corrosion resistance



Isobar™ TTL Module In complements the versatile osteosynthesis system of Scient'x- Alphatec Spine by providing a low-profile top-loading degenerative instrumentation.

The Isobar™ TTL Module In system is implanted via a posterior approach. Isobar™ TTL IN is indicated for the correction and stabilization of the following spinal conditions: isthmic lysis with spondylolisthesis, spondylolisthesis and/

or spondylolysis, severe discoligamentary instability, major disc weakening, primary or iatrogenous instabilities, lumbar canal stenosis, degenerative scoliosis.

The Isobar™ TTL Module In implants are available in different sizes to adapt to the patient's anatomical structures and surgeons' needs. The resulting construct stabilizes the spine in a desired balance and favors the arthrodesis.

Full range of Ø5.5mm rods

- > Pre-bent rods for low back available from 45 to 95mm
- > Straight rods ranging from 45 to 400mm
- > Isobar™ compression rods
 - Controlled micromotion in all the 3 planes
 - Axial compression and distraction
 - Stimulate the interbody space to promote fusion, by the principles of Wolff's law
 - Decrease stress on bone/screw and screw/rod interfaces which is especially beneficial in elderly patients
 - Prevent stress-shielding at the instrumented level and overloading at the adjacent level

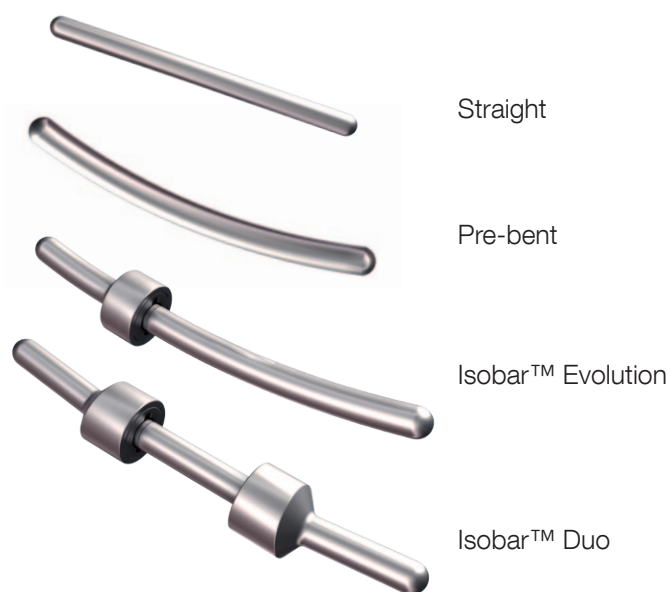

Easys™ crosslink system

- > Increased stability of posterior fixations
- > Very easy to implant
- > Immediate self-locking by clamping on the osteosynthesis rods

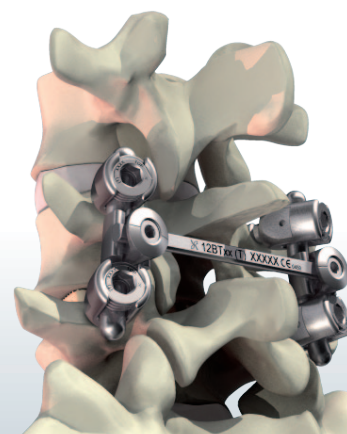

Note: For all instruments including rack or spring blades, pay special attention to their handling that might damage the gloves.

1 Pedicle hole preparation

Isobar™ TTL Module In implants are indicated for pedicle-screw based posterior fixation for lumbo-sacral spine. Therefore the surgeon must be trained to this technique.

a Triangular awl with stopper: is used to perforate the cortex of the pedicle. A depth-stop at 15mm limits the entry point depth

b Straight or curved pedicle spatula: Calibrated and laser etched with 10mm intervals, they are used to perform the pedicle path.

c Palpator: is used to check the prepared pathway wall integrity and bone quality.

Repeat action symmetrically for each pedicle site to be instrumented.

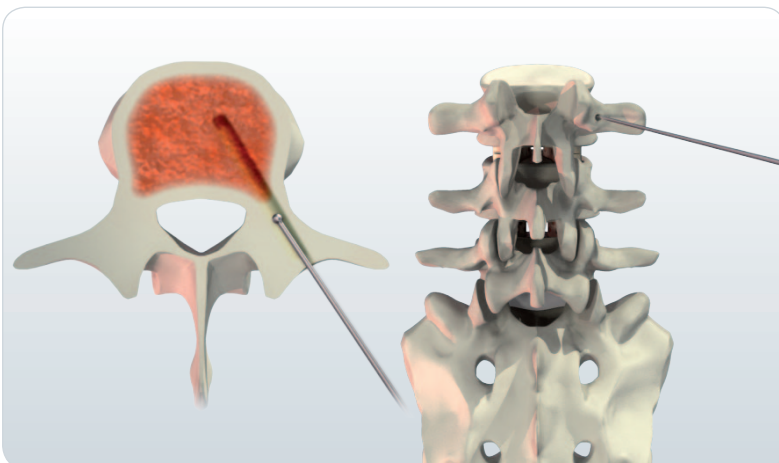
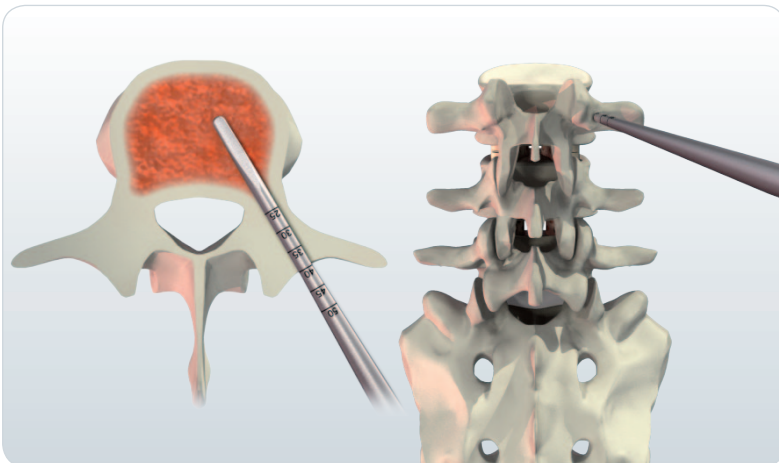
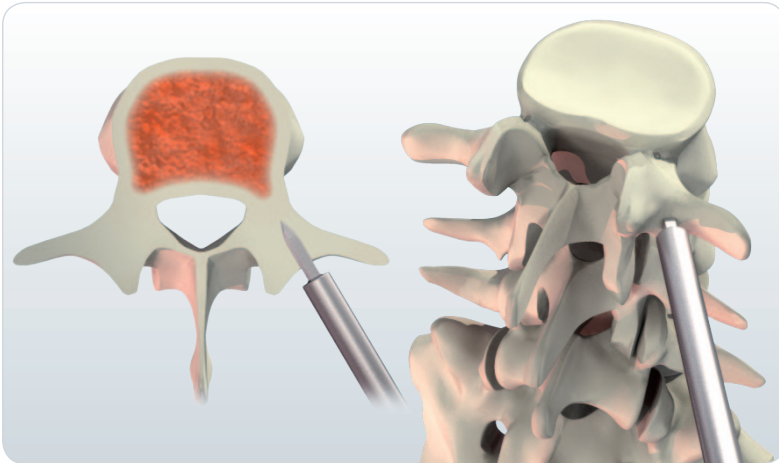

2 Tapping (optional step)

Isobar TTL - Module In screws are self-tapping; however, taps may be used to facilitate screw insertion.

Select the appropriate tap size and connect to a ratcheting axial or T-handle with a Hudson connector.

Note: The color-code on taps corresponds to the diameter of the pedicle screws they are designed to be used with:

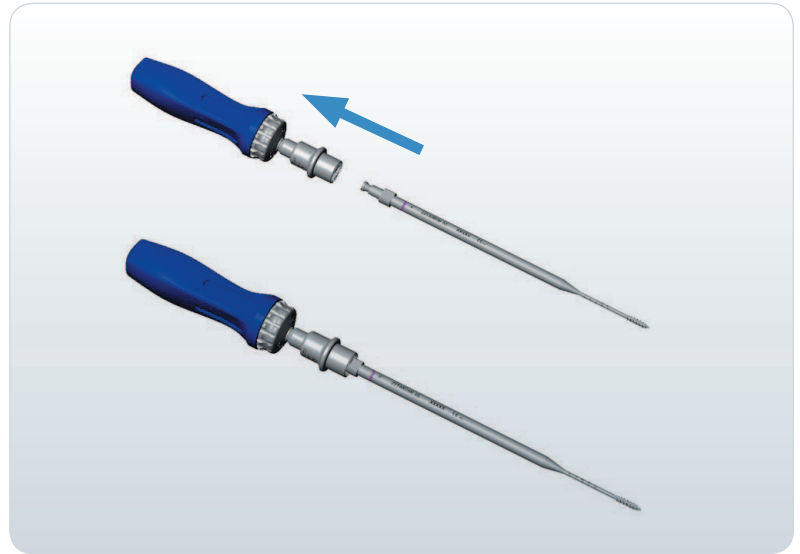

screws of diameter:

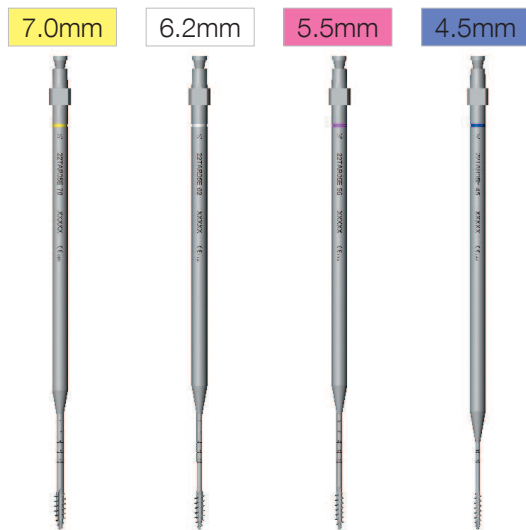

Diameter of the tap is 1mm less than the diameter of the corresponding screw.

Etching on tap indicates depth of insertion.

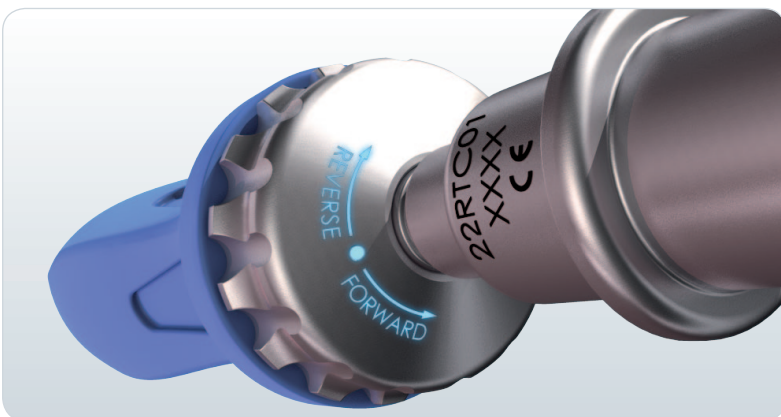
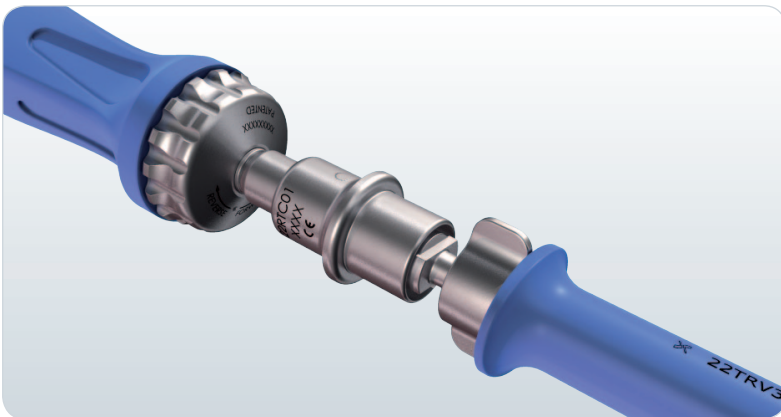
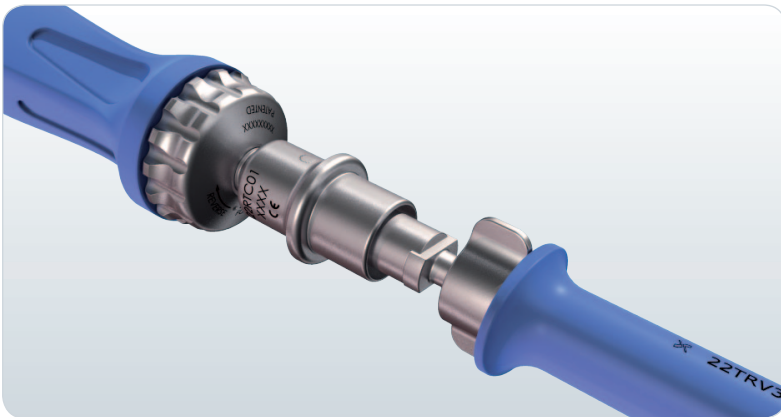
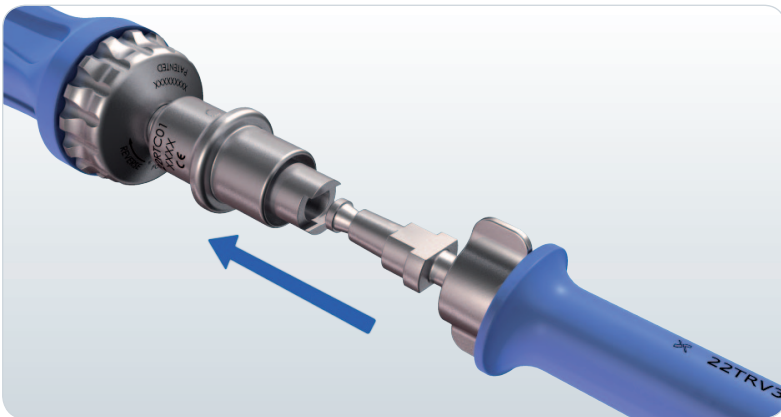

3 Insertion of the pedicle screw

Isobar™ TTL Module In screws are available in polyaxial or monoaxial version. The use of In-screws is recommended for short constructs and when screw alignment can be obtained easily. Scient'x-Alphatec Spine recommends selecting a pedicle screw as long and thick as possible according to patient's anatomy. Screw dimensions can be checked by marking on the head or with measurements guides on the screw racks.

a Screwdriver Assembly

Assemble the screwdriver by attaching it to the ratchet handle HUDSON fixation.

Hudson Fitting Explanation

Simply pull back the outer ring on the handle, insert the screwdriver base into the ring, and release.

Ratchet Mechanism Explanation

The 3 positions on the ratchet mechanism can be engaged by turning the serrated ring on the handle clockwise (forward), counter-clockwise (reverse) or not at all (neutral).

Forward or neutral positions are selected when connecting and implanting the screw on the screwdriver.

Note: Other Scient'x-Alphatec Spine handles with HUDSON fixation can be used according to surgeons' preference.

b Then, connect the screw to the screwdriver.

First align the flanges at the distal end of the screwdriver with the U-shape of the screw head. Turn the handle clockwise until the winglet rotates.

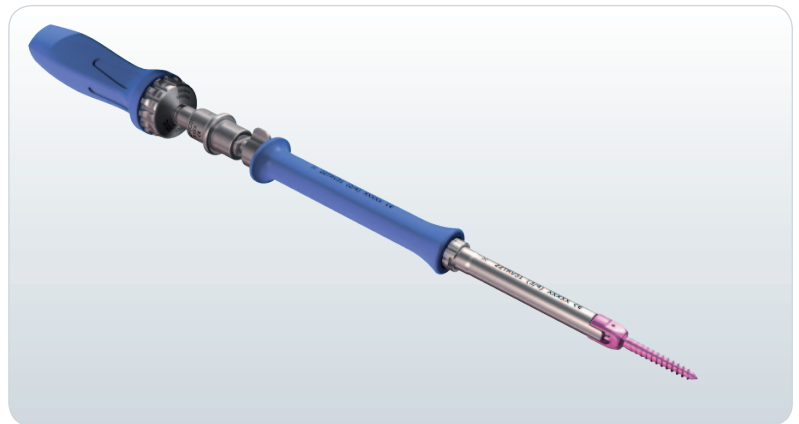

To lock head, hold the metallic winglet, while tightening the handle.

Note: The operator should check the coaxiality of the screw head with the bone screw prior to tighten the handle.

Note: The flanges should remain connected to the screw head to prevent pinching soft tissues



c Then, insert the screw into the prepared pedicle path.

Advance the screw until all of the bone thread is inserted into bone to ensure a good purchase.

Note: When inserting a screw on a level above or below a level already instrumented, the screw heads should not be in contact to enable the use of the counter-torque key.

Note: Removal screwdriver can be used to insert monoaxial or polyaxial screws if the screwdriver is not available.

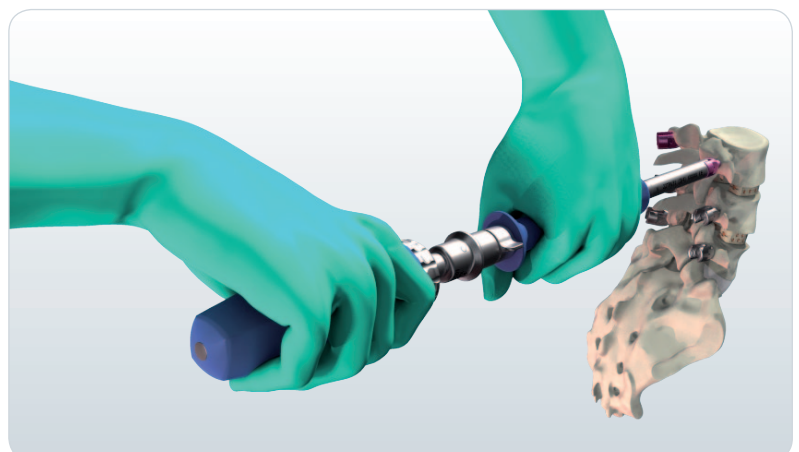



d To release the screwdriver from the screw, place the ratchet in reverse or neutral position. Hold the winglet and turn the handle counter-clockwise.

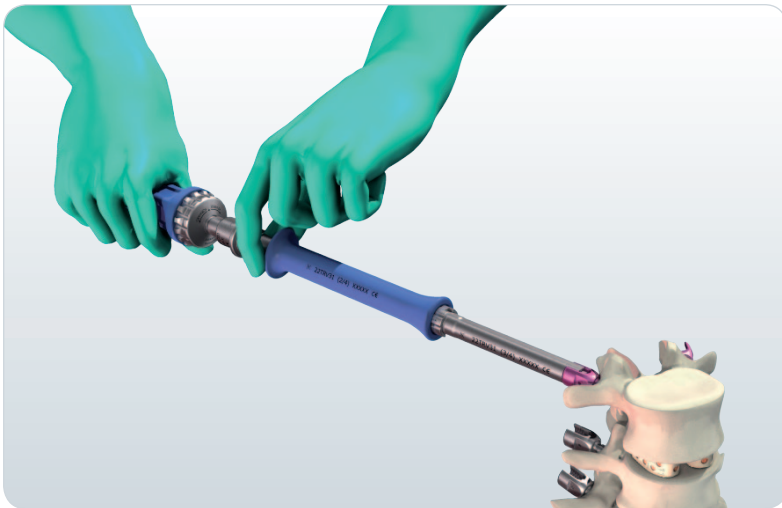

Repeat action for each pedicle site to be instrumented.

Warning: Under no circumstances shall the screwdriver be reconnected to an implanted screw in order to reposition or remove the pedicle screw after it was disconnected. For such purpose, the removal screwdriver is available in the set.

4 Insertion of the rod

a Rod selection

The correct size of rod must be determined so it does not interact with the non-operated levels.

While using semi-rigid rods, rod length must be selected to best align the dampener at the level of the intervertebral space and to avoid interaction with non-operated levels.

b Rod bending

The rods from 45 to 95 mm are pre-contoured. If necessary, prior to inserting the rod, the lordosis can be modified using the small French bender or the French bender.

Warning: Repeated or excessive bending can weaken the rod.

While using Isobar™ compression rods, if necessary, 85mm or longer rods lordosis can be gently modify only in their longest rigid part.

The lordotic profile of a semi-rigid rod has to be checked prior to insert it: if need be, rotate the long end of the rod relative to the housing to align the lordotic curve. On Isobar™ Evolution rods, laser marking helps this maneuver.

Warning: No bending is allowed on Isobar™ Duo rods. No In-situ bending are allowed on any semi-rigid rods. Make sure the bender does not touch the dampener at any time.



c Rod holding

Use the small rod pliers (or the rod pliers) to have a firm grip.

Note: If the head of a screw is not aligned, use the removal screwdriver or the screw head repositioner. The screwdriver should not be reconnected to the polyaxial screws.

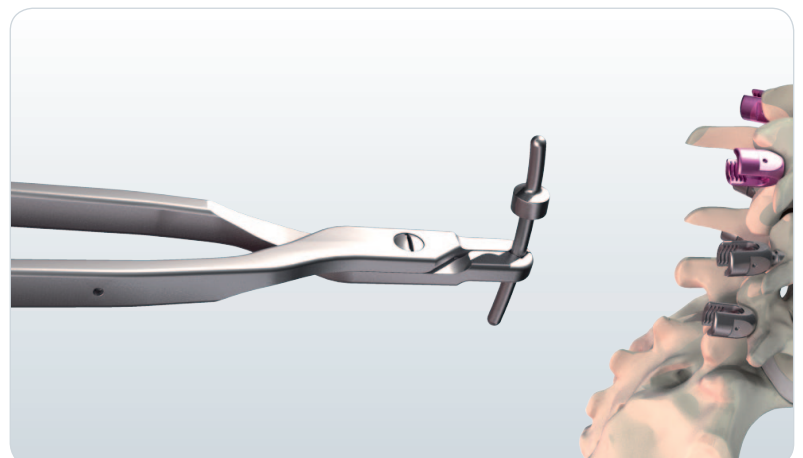

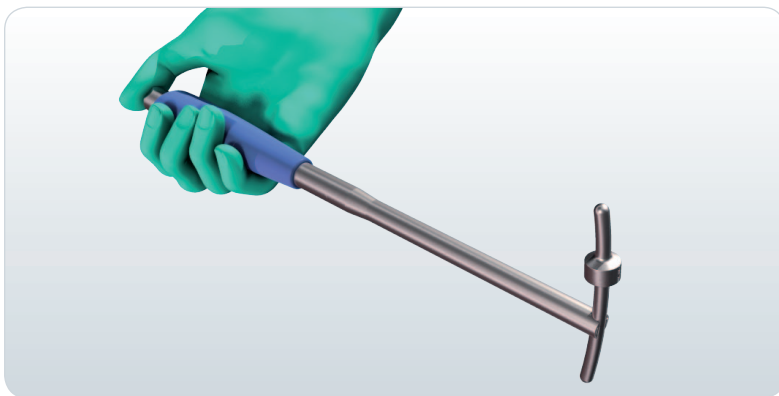
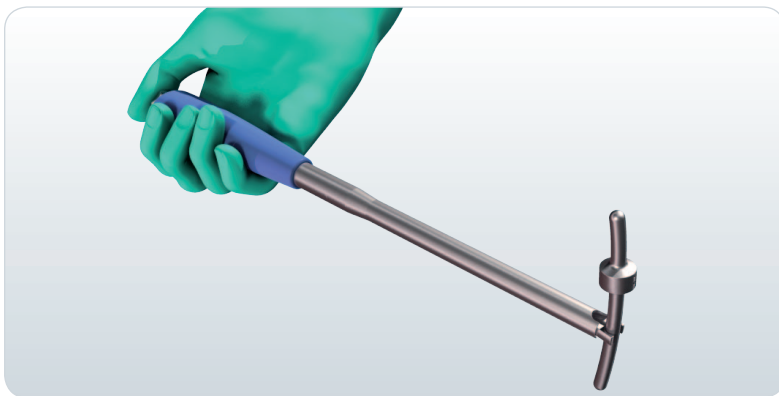
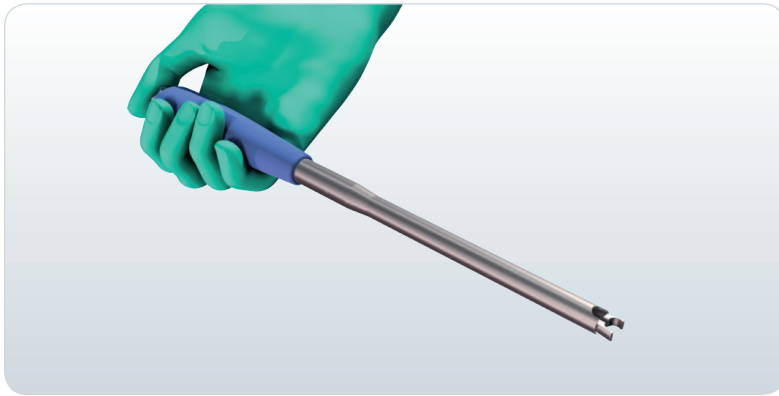

Use the rod holder for a lighter and easier positioning. (Press onto the top button to grab the rod)

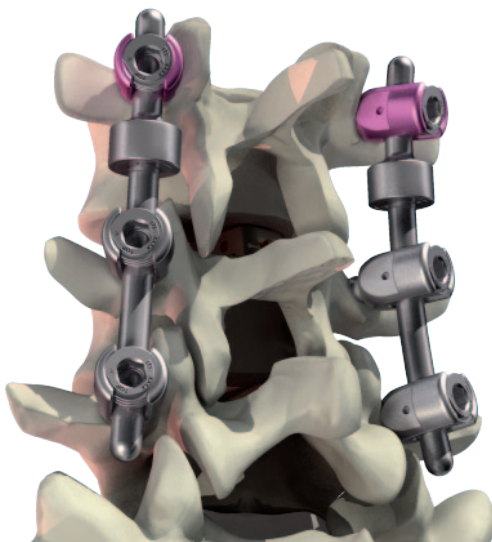

Warning: While using the Isobar™ compression rods, equivalent rod lengths must be placed bilaterally to ensure that the dampeners are positioned at the intervertebral space and at the same level in the transverse plane (directly posterior to the intervertebral space) to ensure proper biomechanical loading.

As with all rods, the extremity should extend beyond the edges of the screw head to ensure correct capture and subsequent locking.

Repeat action symmetrically with a second similar rod.

5 Insertion of the inner nut (set screw)

Insert the nut into the screw head using the inner nut screwdriver without any handle.

To facilitate the insertion, if necessary, push the down in the screw head using one of the three following options.

The rod should rest against the washer to facilitate the insertion of the inner nut. There are 3 options available to secure the rod down into the screw head:

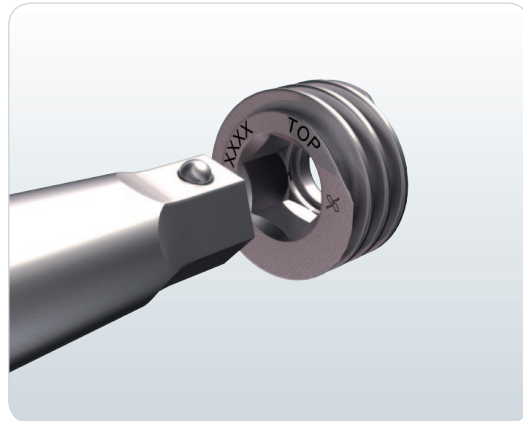

Option 1: Rod pusher

The tip should rest against the screw head to prevent any slippage. If the rod is not yet into the tulip of the screw head, then this instrument shall not be used.

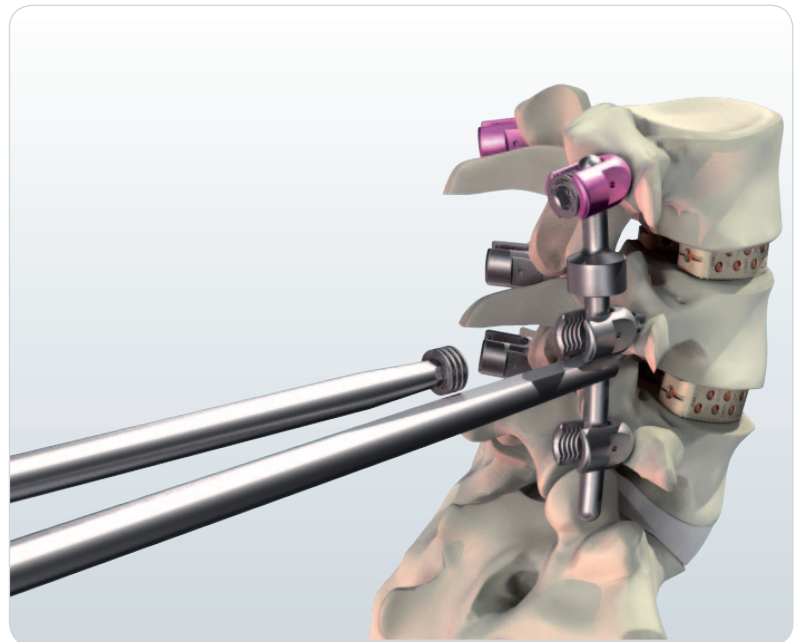

Option 2: Rocker

The rocker must be hooked on the two lateral recesses of the screw head. The instrument is rocked away from the screw to lower the rod.

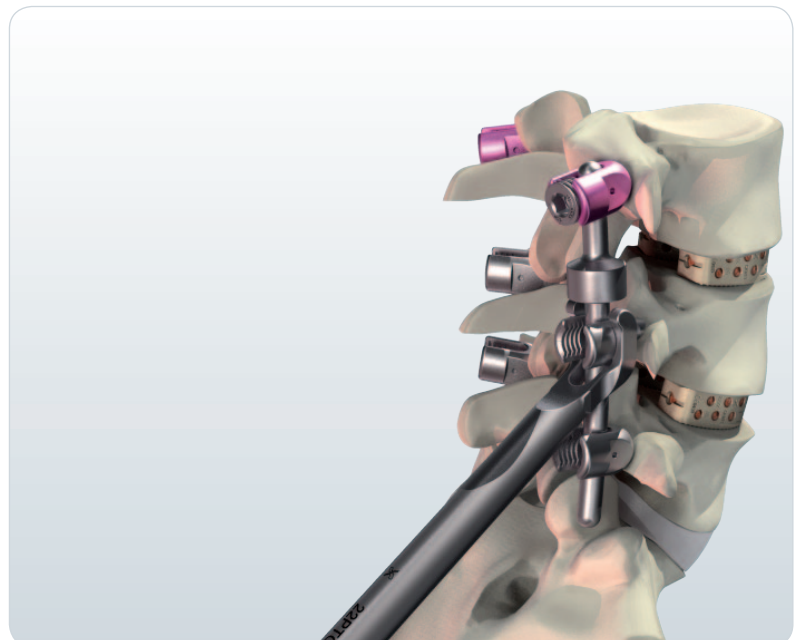

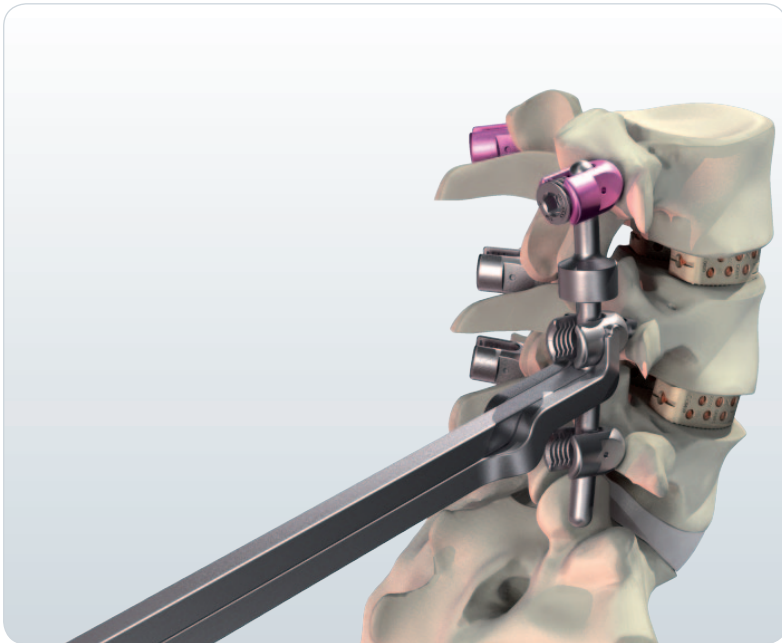

Option 3: Persuader

The persuader must be hooked on the two lateral recesses of the screw head. Squeeze the handle to lower the rod.

Warning: Isobar™ compression rods must be implanted in a neutral position and without pre-load. Avoid applying pre-load when inserting and finally tightening inner nuts.

Repeat action to insert a nut in each inserted screw.

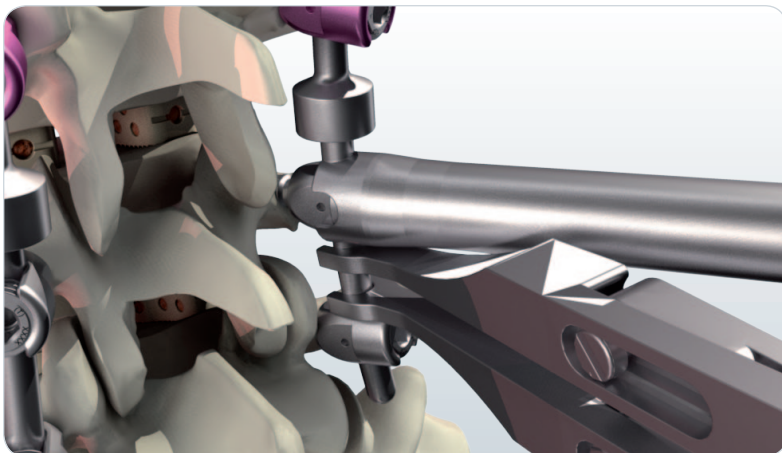

6 Maneuvers (Optional step)

If need be, the distraction & compression pliers (parallel or not) are used to distract or compress the construct. The tips are placed on the rod and rest either on the screw head or on the counter torque key placed on a working screw.

The inner nut of the working screw should be slightly loosened prior to distracting or compressing the segment.

Warning: Excessive compression / distraction can result in damage of anatomical structures and compromise bone/screws interface.

Note: Millimetric distraction / compression might be performed using the small thumb wheel on the rack of the parallel pliers.

Important: At the top or bottom end of the construct, the rod must overhang out of the screw heads to allow for proper tightening of the construct.

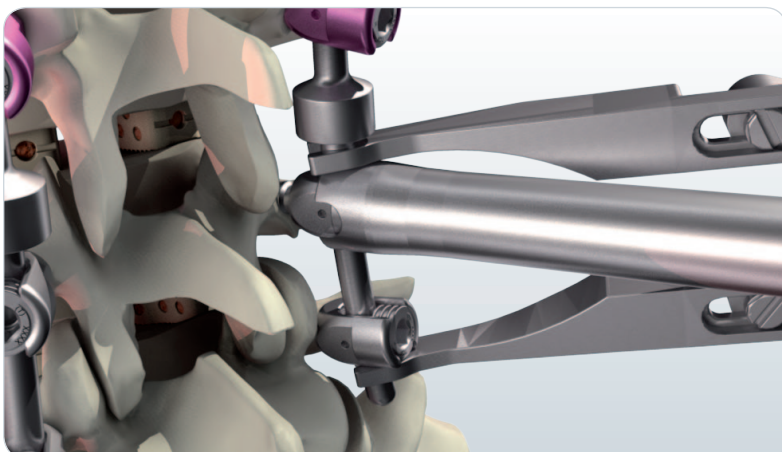

Final tightening

The inner nuts are strongly tightened with the inner nut screwdriver connected to the torque wrench key HUDSON fixation (Connection is performed as described on page 5).

It is mandatory to use the inner nut screwdriver in combination with the counter-torque key to protect the screw from any flexion or torsion loading.

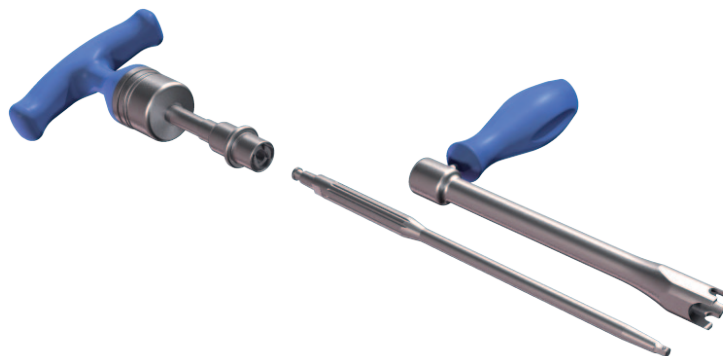

The counter-torque key is placed onto the pedicle screw. Then, the inner nut screwdriver connected to the torque wrench key can be inserted into the hexprint of the inner nut.

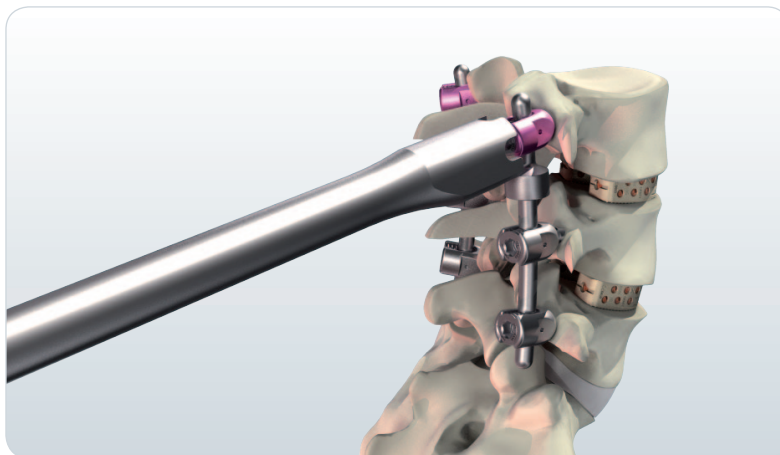

To allow both perpendicular (A) or parallel (B) placement on the rod, the counter-torque key has four openings.

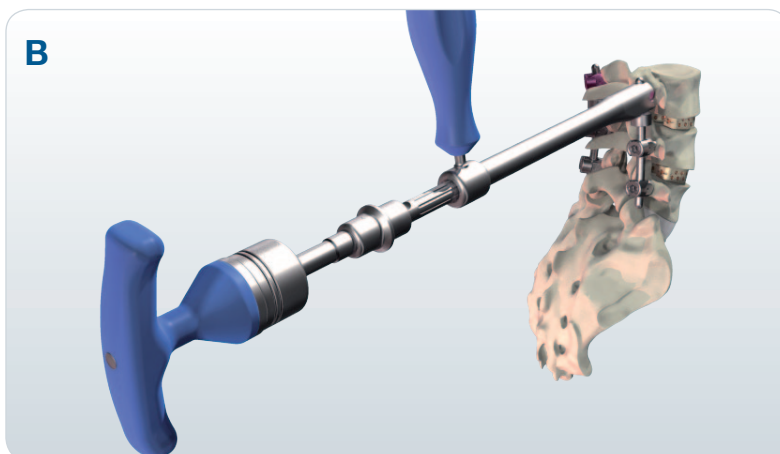
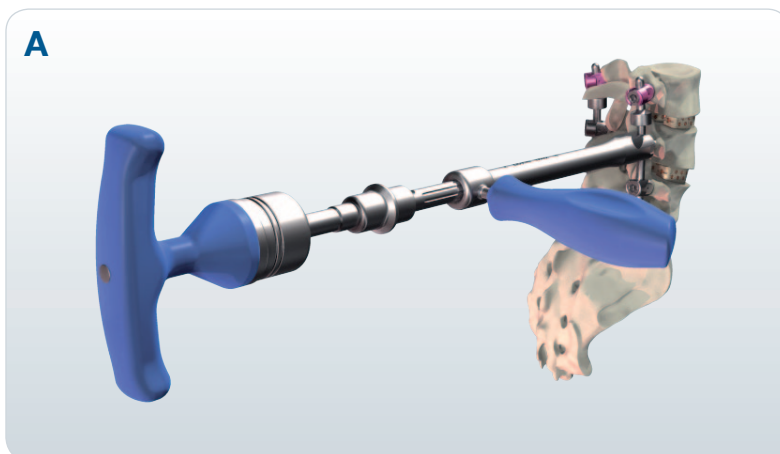



Counter torque
22CCC08



Counter torque
22CCC10

Two counter torque keys are available:

- One is to be used with rigid rod constructs.
- One is to be used with semi-rigid rod constructs.

Important: If needed, it is strongly recommended to only use the counter torque key to move tissues away from the approach. Under no circumstances shall flexion nor torsion stress be applied to the inner nut screwdriver. The rod should be fully engaged in the openings of the instrument prior to tightening the inner nut.

Turn the torque wrench key until it clicks, then the prescribed torque of $11.3 \pm 2 \text{N.m}$ is reached.

Repeat action for all nuts.

Important: Set screws are intended for single use. After final tightening, due to the calking of the washer, if the set screw has to be removed the pedicle screw should be removed as well and replaced by a revision screw.

8 Adding a transverse-link system (Optional step)

Transverse-link system(s) can be added to the construct. The Easys™ system has been included in the set.

Important: The surgeon must be familiar with the technique and Instructions For Use.



Take the straddler with the connecting element holder, and simply snap it on the osteosynthesis rod.

Repeat with the second straddler.

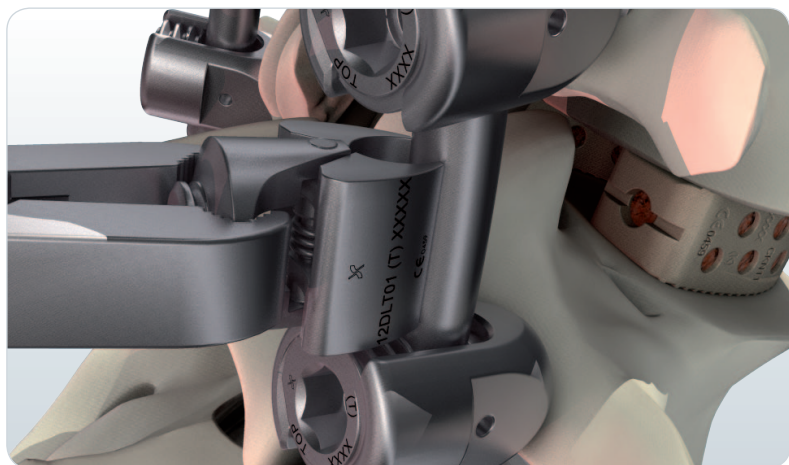

Slide the transverse bar into one and the other straddlers.

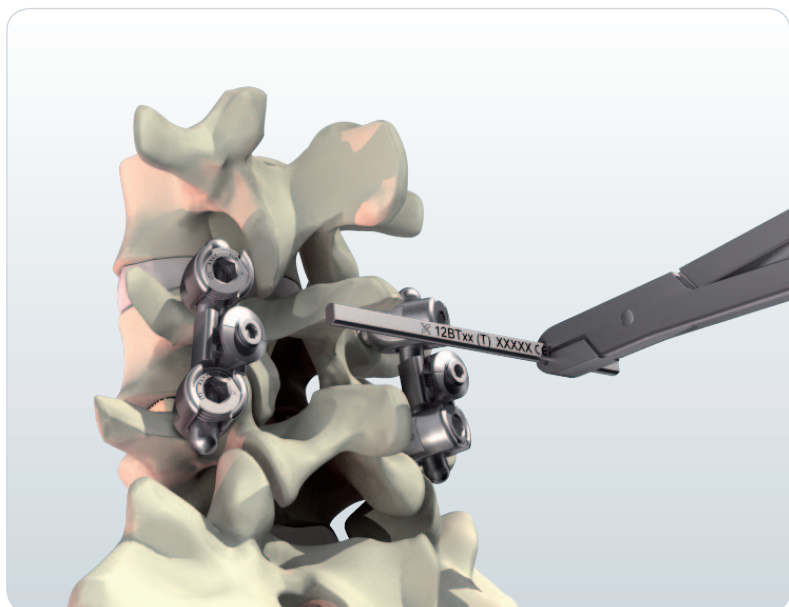

Tighten the pressure screw with the Torque limiting screwdriver.

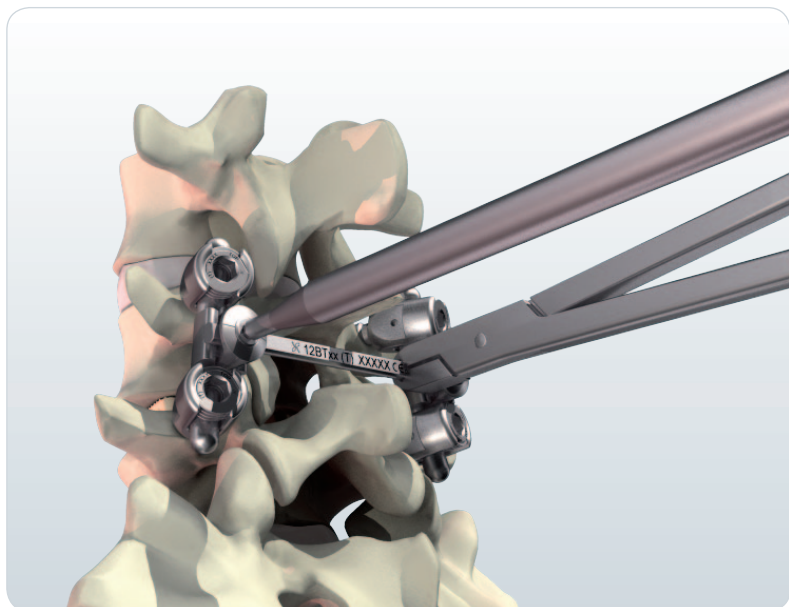

9 Reduction screws (optional step)

Isobar TTL - Module In / Reduction screws are available in polyaxial and monoaxial versions. The reduction screws and instruments may be utilized to facilitate rod reduction in cases with difficult anatomy or when spondylolisthesis reduction is required.

a Insertion of the reduction screws

Connection of the screwdriver to the ratchet handle

The reduction screwdriver for reduction screws is connected to the Hudson connector ratchet handle. The reduction screws are then connected to the screwdriver.

Connection of the reduction screws to the screwdriver

First align the flanges at the distal end of the screwdriver with the U-shape of the screw head.

Turn the handle clockwise to start tightening the screw on the instrument. The inner shaft is driven down and the tip presses onto the bone screw to secure it properly.

To lock the head, hold the metallic winglet while tightening the ratchet handle.

The screw is inserted into the pedicular canal. The screwdriver is held aligned to the axis of the pedicle by means of the sleeve. The flanges should remain connected to the screw head to prevent pinching soft tissues. During insertion, the ratchet handle should not be placed in reverse position.

The screw must be advanced until all the bone thread is inserted into bone to ensure a good purchase.

To release the screwdriver from the screw, the outer tube is held by the metallic winglet and the ratchet handle is turned counter-clockwise. Pay attention to not be in the forward position on the ratchet handle.

Repeat action for each pedicle site to be instrumented with reduction screws.

Warning: under no circumstances shall the screwdriver be reconnected to an implanted screw in order to reposition or remove the pedicle screw after it was disconnected. For such purpose, the removal screwdriver is available in the set.

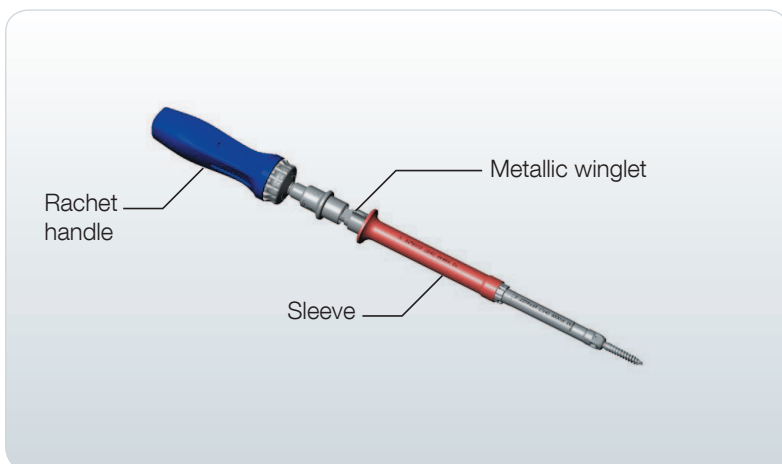
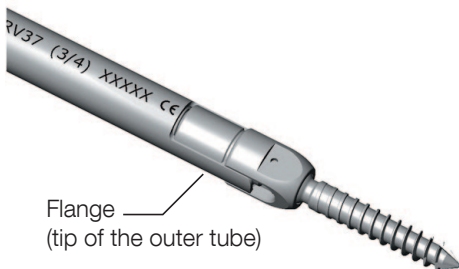

■ Spondylolisthesis reduction

When spondylolisthesis reduction is required, position the rod ensuring that the desired final contour has been created. The rod should remain high in the U-shape of the reduction screws placed in the vertebral body to be pulled back, while fully seated in the U-shape of the surrounding standard screws.

Insert the inner nut in the surrounding implants and provisionally tighten them to secure the rod using the inner nut screwdriver.

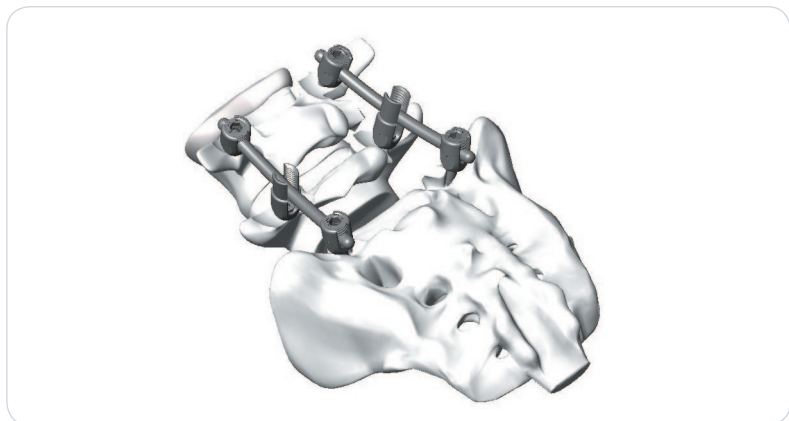

Option 1: Reduction with inner nut and reduction screw tab ring

Use the reduction screw tab ring during inner nut insertion. Advancing the inner nut in the reduction screws will pull the implant to the rod, translating the vertebral body posteriorly and therefore reducing the spondylolisthesis.

Important: Either a reduction screw tab ring or a persuader must be used during inner nut insertion into a reduction screw, in order to prevent screw head opening.

Tip: It is recommended to reduce the rods on both sides of the vertebral body simultaneously.



Option 2: Reduction with inner nut and axial persuader

To use the axial Persuader, guide the distal portion of the Persuader over the top of the screw head. Compress the grips first to hold the head of the screw and then to reduce the rod into the screw head.

Continue to squeeze until the rod is fully seated into the screw U-shape.

Insert an inner nut using the inner nut screwdriver through the cannula and provisionally tighten the nut.

While the inner nut screwdriver is maintain in position, remove the persuader, disengage the release lever and then loosen the handle until the screw head is completely released.

Important: Either a reduction screw tab ring or a persuader must be used during inner nut insertion into a reduction screw, in order to prevent screw head opening.

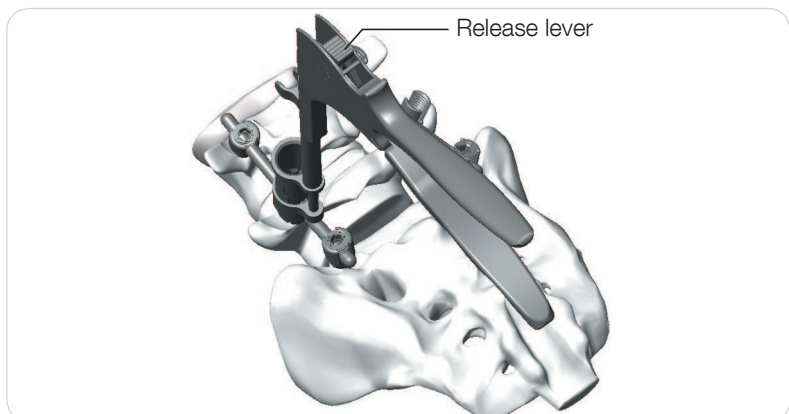
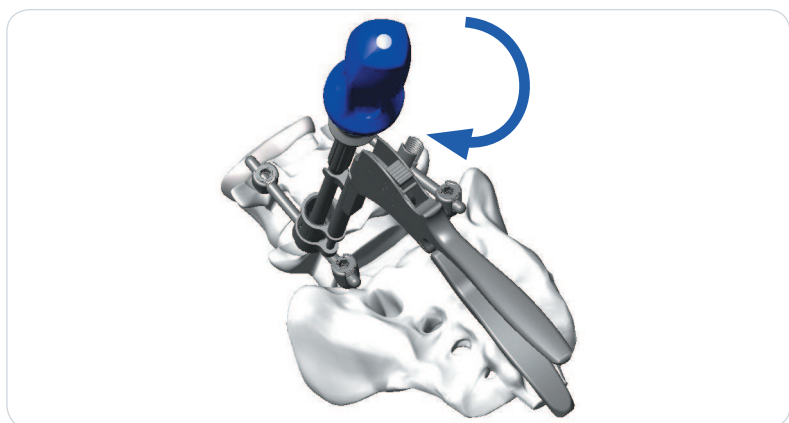

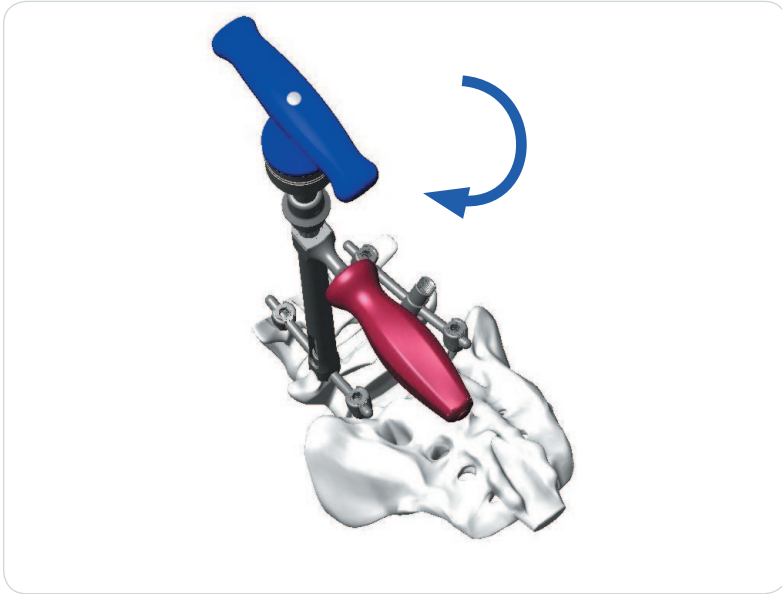

c Final tightening

The inner nuts are strongly tightened with the inner nut screwdriver connected to the Torque wrench key Hudson fixation handle. It is mandatory to use the inner nut screwdriver in combination with the counter-torque key for reduction screws to protect the screw from any flexion or torsional loading.

Important: Be sure to check that the persuader is completely disengaged prior to attempting to reduce a screw.

d Reduction screw tabs breakage

Once the rod has been fully seated and final tightening performed, break tabs off by using the extension head breaker.

Important: Make sure that 2 tabs per reduction screw have been removed from the surgical field.

Tip: During the breakage manoeuvre, the rod can be hold with a forceps or a rod holder.

10 Implant removal (Optional step)

In order to remove the construct, first, untighten the inner nut by counter clockwise turning the inner nut screwdriver connected to a handle with HUDSON fixation.

A T-handle HUDSON fixation* is available upon request. The use of the counter-torque key is mandatory.

Repeat action for each nut.

Then remove the rod using pliers or the rod holder.

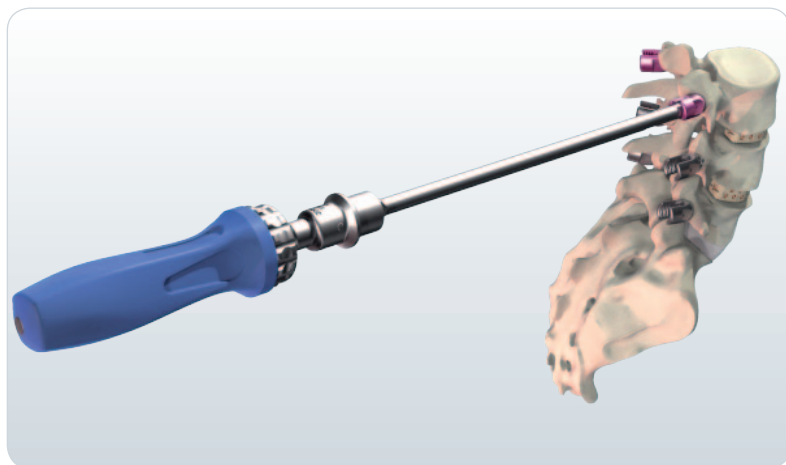

To remove the screws, the removal screwdriver is used for both monoaxial and polyaxial screws preferably connected to the ratchet handle with HUDSON fixation. The tip of the screwdriver is inserted inside the hexagonal shape of the screw head then the instrument is turned to remove the screw.

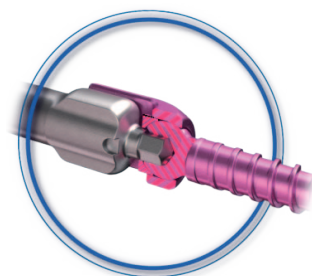

Repeat action for each screw.

Important: the screwdriver (22TRV31) should not be used to remove the poly screws.

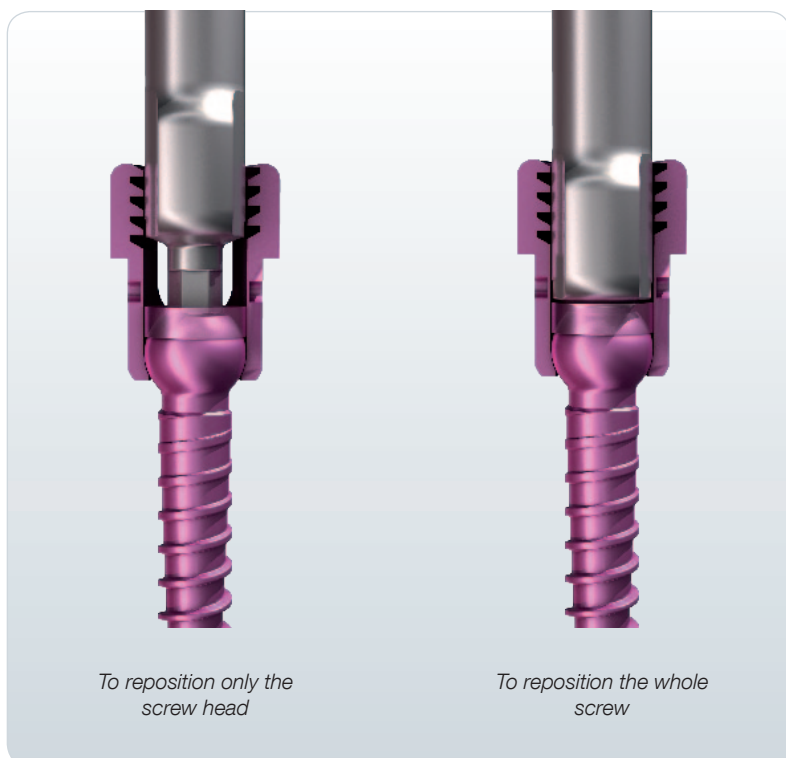

The following instructions have to be observed to ensure a proper decontamination & cleaning of both 22TRV31 and 22TRV37 instruments.

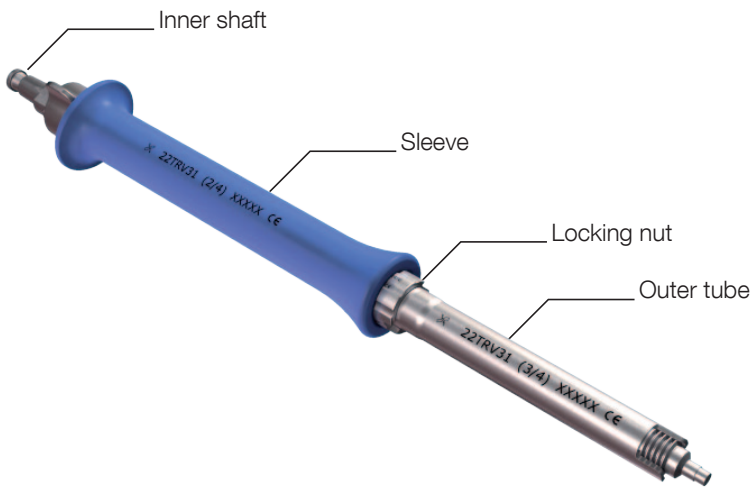

Screwdriver elements

The screwdriver is composed of 4 parts

- 1- the inner shaft
- 2- the outer tube
- 3- the sleeve
- 4- the locking nut

Dismantling of the screwdriver

- 1- Untighten the locking nut with the locking key. The key has 2 fins inserted in the locking nut.



2- Remove the locking nut and the sleeve.



3- Untighten the inner part by turning it clockwise. Once the threads are disengaged, pull it out of the outer tube.

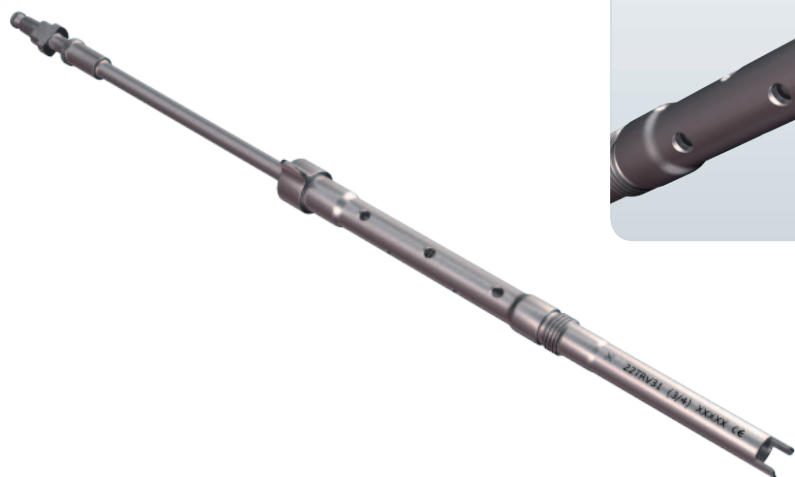
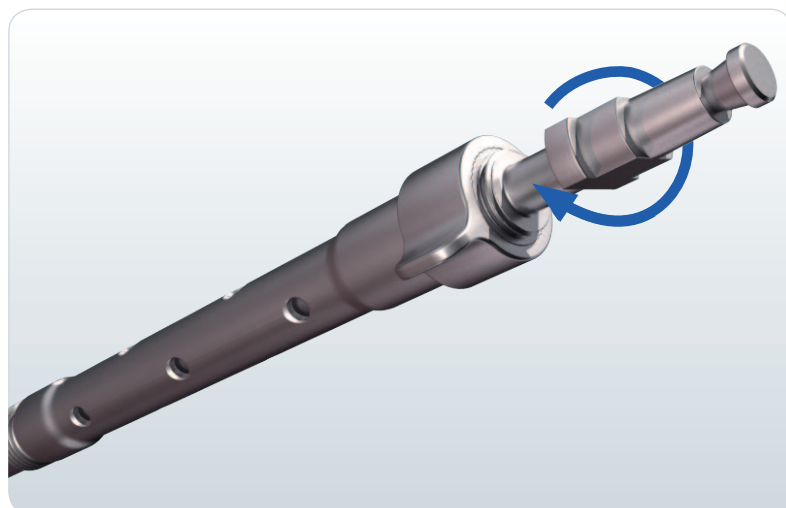

Mounting of the screwdriver

Perform the three steps above in reverse order:

1- Slip the inner part in the outer tube and engage the threads by turning counter-clockwise.

2- Insert the sleeve and the nut and tighten the nut clockwise.

3- Apply final tightening using the locking key.

ISOBAR™ TTL

Module In

INSTRUCTIONS, IMPLANTS & INSTRUMENTS

Instruction for use

■ OBJECTIVE

Implants from ISOBAR TTL and Aladyn[®] are designed for the surgical treatment of the spine through a posterior approach and intended to help the stabilization of spinal segment(s) as an adjunct to fusion.

■ GENERAL DESCRIPTION

The ISOBAR TTL spinal osteosynthesis system consists of the following modules:

U-line module that enables vertebral anchorage by means of U-shape heads screws either monoaxial or polyaxial combined with 5.5 mm diameter rods locked by a blocker nut.

D-line module consists of hemispherical, monoaxial or polyaxial pedicle screws on which are placed various types of clamps connected to a 5.5 mm diameter rod. The tightening of the construct is performed by hemispherical nuts.

Hooks module (U-shape or hemispherical) can be added if needed.

Scoliosis module provides specific instruments to be combined with U-Line, D-Line and Hooks modules for specific indications.

MX module combines 3 types of pedicle screws: closed monoaxial screws, and monoaxial and polyaxial screws with lateral introduction, combined with 5.5 mm diameter rods. The rods are bolted in position by a set screw inside the head of the pedicle screw.

In Module consists of monoaxial or polyaxial pedicle screws combined with 5.5 mm diameter rods locked by an inner set screw.

Each module has dedicated instruments to be used with the implants, in addition to standard and optional sets of common instruments.

Isobar Semi-Rigid rods range is composed of 5.5 mm diameter titanium rods and include semi-rigid (Isobar), low-profile semi-rigid (Isobar Evolution) and Semi-rigid Dual Dampener rods (Isobar Duo).

The ALADYN[®] system consists of monoaxial or polyaxial pedicle screws associated with semi-rigid or rigid plates. Pedicle screws can also be connected to 5.5 mm diameter rod in combination with clamps. For both options, the tightening of the construct is performed by hemispherical nuts.

All these implants of various modules come in several sizes in containers, pouches or sterile boxes; a great variety of combinations of fixation systems is therefore possible in order to obtain a made-to-measure treatment.

The ISOBAR TTL and Aladyn[®] implants are made from titanium and titanium alloy parts that can be implanted in accordance with

standards ISO 5832-2 or ASTM-F 67, and ISO 5832-3 or ASTM-F 136. They are not compatible with stainless steel or other metals. The components of the ISOBAR TTL and Aladyn[®] systems must not be used with components from other manufacturers or other Scient'x systems, except if clearly stated otherwise in another Scient'x system instructions for use.

■ SUITABLE FOR

The components of the ISOBAR TTL and Aladyn[®] systems are surgical implants designed for posterior spinal osteosynthesis. The screw modules (i.e. U-line, D-Line, MX and In) of the ISOBAR TTL system as well as components of the Aladyn[®] system are intended to provide stabilization of spinal segment(s) as an adjunct to fusion in the treatment of the following acute and chronic instabilities (primary or iatrogenic) of lumbar and sacral spine:

- Spondylolisthesis and/or spondylolysis (with or without isthmical lysis),
- Severe discoligamentary instability,
- Major disc weakening,
- Lumbar canal stenosis,
- Degenerative scoliosis*
- Failed previous fusion.

***Important:** When used with plates (rigid or semi-rigid), Aladyn[®] system is not indicated in degenerative scoliosis and plates should be used in combination with pedicle screws implanted at lumbar and sacral levels.

In addition to the aforementioned indications, the U-Line, D-Line and/or Hooks modules can be used in the following thoracic, lumbar and sacral indications:

- Fractures (burst and/or luxation and/or dislocation)
- Scoliosis,
- Kyphosis;
- Spinal tumour.

Restriction: Isobar Semi-Rigid Dual Dampener rods should be used in combination with pedicle screws implanted at each lumbar and sacral level.

The scoliosis module combined with U-Line, D-Line and Hooks modules allow in addition to all the indications listed above to treat severe scoliotic deformities.

All components of the ISOBAR TTL or Aladyn[®] systems are intended to be removed after solid fusion is assessed.

■ CONTRAINDICATIONS

Contraindications for the ISOBAR TTL system include:

- infection or local inflammation,
- vertebral osteoporosis,
- pregnancy,
- allergy to or intolerance of titanium and Titanium alloys,
- Patient unable to conform to post-operative recommendations,
- Patient age and physical condition incompatible with surgery,
- any case not included in the above list of suitable cases.

The ISOBAR TTL and Aladyn[®] systems are not designed, intended or sold for any use other than those indicated.

■ POSSIBLE SECONDARY EFFECTS

Among all of the possible adverse events associated with spinal fusion surgery, instrumented surgery can lead to potential adverse events including, but not limited to:

- Metal sensitivity to a foreign body, including possible tumour formation
- Non-union or delayed union
- Pain or discomfort
- Wound complications including infection
- Bone loss due to resorption or stress shielding, or bone fracture at, above, or below the level of surgery
- Nerve or vascular damage due to surgical trauma, including loss of neurological function, dural tears, fibrosis, radiculopathy, paralysis and cerebral spinal fluid leakage
- Misalignment of anatomical structures, including loss of proper spinal curvature, correction, reduction and/or height
- Inability to resume activities of normal daily living
- pseudarthrosis
- adjacent segment disease

Note: An additional surgical operation may be required to correct a secondary effect. The surgeon should inform the patient on these potential side effects.

Precaution: An entirely satisfactory outcome is not always achieved with each surgical operation. This is particularly true in spinal surgery where a number of external factors can compromise the results.

■ OPERATING PRECAUTIONS

This product is a single use device. Under no circumstances should it be reused. While the device may appear to be undamaged, it may have small defects or internal stress patterns, as a result of the prior implantation or removal that could lead to fatigue failure. Additionally, please note that the removed implant has not been designed or validated so as to allow for decontamination of microorganisms. Reuse of this product could lead to cross-infection and/or material degradation as a result of the decontamination process. The company accepts no responsibility for products which have been reused. The (single use) symbol on the label is a reminder of this precaution.

Precaution: The implantation of pedicle screw spinal systems should be performed only by experienced surgeons with specific training in the use of this pedicle screw spinal system because this is a technically demanding procedure presenting a risk of serious injury to the patient.

Pre-operative phase: The surgeon must be perfectly familiar with the ISOBAR TTL or Aladyn3 systems, the associated instruments and the surgical technique. The surgeon should check that no factors of biological, biomechanical or other origin will interfere with the operation and its subsequent effects. The surgeon should consider the levels of implantation, patient conditions (weight, bone quality, ...) which may impact the performance of the systems. An adequate inventory of implants should be available during the operation. The medical team should also ensure that all the instruments required are functional before the operation. The instruments which are able to jam, like pliers and screwdrivers must be lubricated with medical instruments lubricant. Scient'x recommends control and/or recalibration of torque limiting devices every 100 sterilization cycles in order to make sure that the recommended torque value is constant. This can be done by sending the device to Scient'x S.A.

Intra-operative phase: Osteosynthesis performed with IsoBar TTL or Aladyn3 systems must be accompanied by arthrodesis at each instrumented level. Posterolateral or Interbody grafting should be added and surgeons must be trained to these additional techniques.

Vertebral fixation with hooks: The hooks are positioned after having prepared the receiving site with instruments appropriate to each type of hook. The hook once positioned must not give rise to any compression or protrusion into the canal. Two types of hooks are available: single hooks and claw-hooks. Four shapes are designed in accordance to receiving sites: pedicle, transverse, supralaminar & infralaminar.

Vertebral fixation with pedicle screws: The screws are to be positioned in the middle of the pedicles. It is imperative to withdraw and reposition an incorrectly positioned screw. Screws must be inserted on the whole length of the bone screw thread. The non-threaded bone screw part should not be inserted into the pedicle to keep the head mobility when using polyaxial screws and to prevent from high stress in every type of pedicle screws. Check correct implant positioning by intraoperative X-rays. Selected screws should be as long as possible and must not protrude through the anterior cortical bone. The screw diameter must be chosen as large as possible according to the pedicle dimensions. The screw dimensions (diameter and length) must be checked prior to the insertion thanks to either the part number or the available tools (pedicular screw gauge or templates on the racks). The pedicle spatulas are used to perform the hole in the pedicle and to measure it. The measure is indicated in mm from 10 to 50 mm (pitch of 10 mm, with a precision of 0.2 mm).

The implanted ISOBAR TTL or Aladyn³ systems must always include two similar rods or plates.

For osteosynthesis with ISOBAR TTL or Aladyn³ involving 3 or more vertebrae, hemispherical screws connected with clamps to a rod should preferably be used in order to prevent misalignment. The rods should not be repeatedly or excessively bent nor be reverse bent in the same location. For Semi-Rigid rods, bending may be gently performed on the extended rod portion for rod lengths greater or equal to 85mm. Rod benders should not interact with the dampener. Bending is not allowed for Dual Dampener rods nor any plates of the Aladyn³ system. The rod or plate length must be adapted to the desired distracted interpedicular distance and wherever possible should not interact with the free levels above and below the instrumented ones. If the rods are cut to length, they should be cut in such a way as to create a flat, non-sharp surface perpendicular to the midline of the rod. Cut the rods outside the operative field. Whenever possible, use pre-cut rods. The rod ends should extend beyond the edge of the screw head to ensure proper locking.

When using ISOBAR or Aladyn semi-rigid rods or plates, equivalent devices must be placed bilaterally such that the dampeners are positioned at the same level in the transverse plane (directly posterior to the intervertebral space) to ensure proper biomechanical loading. Semi-Rigid implants must be implanted in a neutral position and without preload. More specifically the lordotic profile of the ISOBAR semi-rigid rods should be checked and corrected if needed by rotating the rigid part relative to the other. Do not try to use the rods nor plates when interpedicular distance is not adequate: the dampener should be far enough off the screw heads to allow for the use of the counter torque key. The rod pusher, the rocker, the persuader and the screw head

repositioner are able to push the rod into the screw head during the inner nut insertion. If one of them is not functional, one of the others can be used.

The tightening of the construct with nuts / set screws is an important step of the surgery, whatever the implant used from ISOBAR TTL or Aladyn3 systems. Take care to tighten the nuts / set screws to the recommended torque that can be applied with the dedicated instrumentation, especially using a counter-torque key to protect the construct and bone during final tightening

When using Hemispherical screws or hooks, the convex part of the nut is applied to the clamp. The recommended torque to apply is 8.2 Nm (73in-lb) When using U-screws or hooks, the concave part of the central part of the blocker nut is applied to the rod. The recommended torque to apply is 11.3 Nm (100in-lb).

When using Module In screws, the recommended torque to tighten the inner nuts is 11.3 Nm (100in-lb).

When assembling a standard connecting bar on a rod with the ISOBAR system, it is imperative to have the best contact between straddlers and the rods. Scient'x recommends the use of the EASYS connecting device (please refer to the product IFU's for more information).

Pliers with a rack and/or spring blades must be used carefully to avoid any gloves damage.

The lot numbers and reference numbers of all components of the ISOBAR TTL or Aladyn3 systems that have been implanted must be systematically recorded in the patient's medical file.

Precaution: No silicone, formaldehyde or latex-based product must be implanted with a Scient'x implant.

Post-operative phase: Patients should be informed of the precautions to be taken in their daily life to ensure the longest lifespan possible for the system. The patient should be instructed to avoid any sudden or excessive loading of his spine and informed that non-conforming to these recommendations could have a detrimental effect on the durability of the implants. Regular post-operative examinations should be performed to detect any early signs of implant failure. An appropriate physiotherapy program should be established and implemented.

■ HANDLING - STORAGE

Packages for each of the components should be intact upon receipt. If a loaner or consignment system is used, all sets should be carefully checked for completeness and to ensure that there is no damage prior to use. Damaged packages or products should not be used, and be returned to Scient'x S.A.

ISOBAR TTL and Aladyn3 products must be handled as little as possible and with every precaution. Implants (in their original packing) must be stored with care in a clean, dry atmosphere. Do not expose implants to sunlight or extreme temperatures. Failure to observe these instructions may result in a reduction in mechanical properties that in certain cases could result in their failure.

■ DECONTAMINATION, CLEANING AND STERILIZATION

Products delivered in pouch are not sterile.

Unless marked sterile and clearly labeled as such in an unopened sterile package provided by the manufacturer, all implants and instruments used in surgery must be sterilized by the hospital prior to use. Remove all packaging materials prior to sterilization. All components and instruments should be cleaned and sterilized before use.

For implants delivered sterile: the implants are sterilized by Gamma radiation at doses of 25 to 40 kGy. The expiry date is 5 years. The expiry date of sterile parts is indicated on the packaging.

For implants and instruments not sterile on delivery: all instruments and implants must be disassembled (if applicable), decontaminated, cleaned and sterilized before and after use.

Recommended method:

- **Decontamination:** Plunge the implants and instruments into a bactericidal and fungicidal solution of the didecyldimethylammonium chloride type diluted to 0.5 % (5mL to 1 litre water). Length of soaking: 20 min. Rinse with demineralized water.
- **Cleaning:** Wash the implants and instruments in a LANCER type machine with suitable cleaning products, rinse and dry. Any product that might damage the equipment is forbidden (such as bleach, formol, etc.).
- **Sterilization:** Scient'x highly recommends to sterilize the kit by steam using the following conditions:
 - pre-heating for 25' at 110° (1 bar)
 - vacuum 5' (0.8 bar under atmospheric pressure)
 - heating 5' at 120° (1 bar)
 - vacuum 5' (0.8 bar)
 - sterilization 18' at 134° (2 bars)
 - drying 20' return to room temperature

■ COMPLAINTS

Any healthcare professional (e.g. a surgeon using the product) who has a complaint or who has experienced any dissatisfaction

in the quality, identity, reliability, safety, efficacy, and/or performance of any ISOBAR TTL or Aladyn3 systems should notify Scient'x S.A., or, where applicable, their distributor. In the event of serious incident, or risk of serious incident, having resulted in or liable to result in the death or severe deterioration in the state of health of a patient or user, Scient'x S.A. or the distributor must be notified immediately. When filing a complaint, please provide the component(s) name, reference number(s), lot number(s), your name and address, and the nature of the complaint in full detail.

■ FURTHER INFORMATION

For further information, contact SCIENT'X, Only for information Subject to modification without notification For updated IFU, please contact your local customer service.

Additional informations / Renseignements /
Ulteriori informazioni / Información complementaria

Scient'x **Alphatec Spine**
Solutions for the Aging Spine®

22 avenue Jean Bart
78960 VOISINS-LE-BRETONNEUX - FRANCE
TL +33 (0)1 39 30 69 30
FX +33 (0)1 30 43 82 77
qualite@scientx.com

	Do not use if package is damaged. Ne pas utiliser si l'emballage est endommagé. No utilizzare se la confezione appare danneggiata. No utilizar si el empaque está dañado	
	Non-sterile. Non stérile. Non sterile. No estéril.	STERILE R
	Date of manufacturer. Date de fabrication. Data di produzione. Fecha de fabricación.	 Manufacturer. Fabricant. Produttore. Fabricante.
	Do not reuse. A usage unique. Mono uso. De un solo uso.	 Use only. Utiliser jusqu'au. Utilizare entro. Utilizar hasta el.
	Read IFU. Lire le mode d'emploi. Leggere le istruzioni. Leer el modo de empleo.	



Date of revision : 2010/11

ISOBAR™ TTL

Module In

IMPLANTS

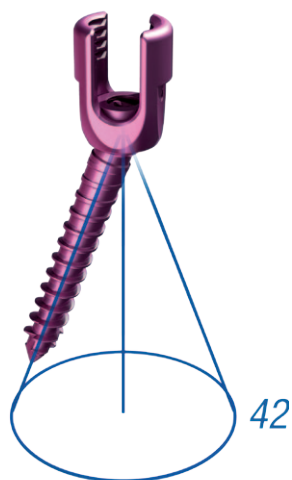

INNER NUT PEDICLE SCREW

Diameter (mm)	Color code	Length (mm)	Polyaxial	Monoaxial
4.5	blue	25	12VTLP45-25*	12VTLM45-25*
		30	12VTLP45-30*	12VTLM45-30*
		35	12VTLP45-35*	12VTLM45-35*
5.5	purple	30	12VTLP55-30*	12VTLM55-30*
		35	12VTLP55-35	12VTLM55-35
		40	12VTLP55-40	12VTLM55-40
		45	12VTLP55-45	12VTLM55-45
		50	12VTLP55-50*	12VTLM55-50*
6.2	silver	35	12VTLP62-35	12VTLM62-35
		40	12VTLP62-40	12VTLM62-40
		45	12VTLP62-45	12VTLM62-45
		50	12VTLP62-50	12VTLM62-50
		55	12VTLP62-55*	12VTLM62-55*
7	gold	35	12VTLP70-35	12VTLM70-35
		40	12VTLP70-40	12VTLM70-40
		45	12VTLP70-45	12VTLM70-45
		50	12VTLP70-50*	12VTLM70-50*
		55	12VTLP70-55*	12VTLM70-55*



RODS

Rod - Diameter 5.5 mm

Length (mm)	Pre-lordosed	Straight	Semi-rigid
45	12TGC55-045	12TG55-045*	12TGN55-50*
55	12TGC55-055	12TG55-055*	12TGN55-55*
65	12TGC55-055	12TG55-065*	12TGN55-65*
75	12TGC55-075	12TG55-075*	12TGN55-75*
85	12TGC55-085	12TG55-085*	12TGN55-85*
95	12TGC55-095	12TG55-095*	
110		12TG55-110	12TGN55-110*
130		12TG55-130	12TGN55-130*
150			12TGN55-150*
200			12TGN55-200*
230		12TG55-230*	
250			12TGN55-250*
300			12TGN55-300*
350			12TGN55-350*
400		12TG55-400*	12TGN55-400*



Isobar™ Duo – Double semi-rigid rod – Diameter 5.5 mm

Length (mm)	Central distance (mm)	Reference
82	35	12TG2S-55-82*
87	40	12TG2S-55-87*

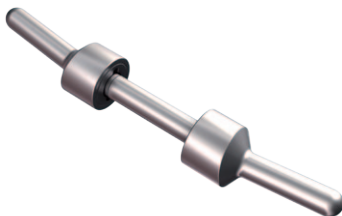

TRANSVERSE-LINK SYSTEM

	Length (mm)	Reference
DLT Straddler		12DLT01
Connecting bar	40	12BT40
	50	12BT50*
	60	12BT60
	80	12BT80
	100	12BT100*

INNER NUT REDUCTION SCREW

Diameter (mm)	Color code	Length (mm)	Polyaxial	Monoaxial
4.5	blue	25	12VTLPH45-25*	12VTLMH45-25*
		30	12VTLPH45-30*	12VTLMH45-30*
		35	12VTLPH45-35*	12VTLMH45-35*
5.5	purple	35	12VTLPH55-35	12VTLMH55-35
		40	12VTLPH55-40	12VTLMH55-40
		45	12VTLPH55-45	12VTLMH55-45
6.2	silver	50	12VTLPH55-50	12VTLMH55-50
		35	12VTLPH62-35	12VTLMH62-35
		40	12VTLPH62-40	12VTLMH62-40
		45	12VTLPH62-45	12VTLMH62-45
		50	12VTLPH62-50	12VTLMH62-50
		40	12VTLPH70-40	12VTLMH70-40
7.0	gold	45	12VTLPH70-45	12VTLMH70-45
		50	12VTLPH70-50	12VTLMH70-50



SET SCREW

Length (mm)	Reference
Inner nut	12BDS01



ISOBAR™ TTL

Module In

INSTRUMENTS

Box # refers to sets layout.

Box #1: Preparation & common TTL instruments

Box #8: Standard Module In instruments

Box #9: Module In instruments

Box #7: Optional TTL instruments

Reduction module



Square awl with stopper

22PT02

Box #1



Palpator

22JAU01

Box #1



Straight pedicle spatula

22SPT03

Box #1



Curved pedicle spatula

22SPT04*

Box #1



Small French bender

22CIN01-2

Box #1



Small rod pliers

21PIN04

Box #1



French bender*

22CIN01-1*

Box #7



Long rod pliers*

22PIN03*

Box #7



Screwdriver

22TRV31

Box #8



Inner nut screwdriver

22TRV32

Box #8



Rod Pusher

22PTG02**

Box #1



Rod holder*

22PRE18*

Box #1 or 7



Ratchet handle HUDSON fixation

22RTC01

Box #8 or 9*



Torque wrench key HUDSON fixation

22DYN02

Box #8 or 9*



Rocker

22PTG04

Box #8



Persuader

22PER01US

Box #9



Counter torque key

22CCC08

Box #8



Counter torque key

22CCC10*

Box #8

*Upon request - Delivery time to be confirmed with order.

**22PTG02 could be replace by 22MNP01 on the order.



Parallel compression plier

22CNT11

Or compression pliers*

22CNT09*

Box #8



Parallel distraction plier

22DST21

Or distraction pliers*

22DST20*

Box #8



T-handle HUDSON fixation

22PGN06*

Box #8 or 9



Screw head repositioner

22MNP01*

Box #9



Transverse connecting element holder

22PIN05

Box #1



Torque limiting screwdriver for transverse connection

22TRV12

Box #1



Locking key

22CLE16

Box #8



Removal screwdriver

22TRV33

Box #8



Snap on screw tap for Øxmm screws 22TAR05E-xx*

Box #9

Ø4.5mm	22TAR05E-45
Ø5.5mm	22TAR05E-55
Ø6.2mm	22TAR05E-62
Ø7.0mm	22TAR05E-70



Reduction screw tab ring

22RS01US*

Reduction module

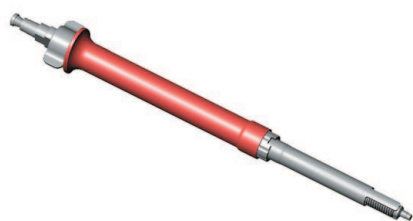

Reduction screwdriver

22TRV37*

Reduction module



Counter torque key

22CCC03US*

Reduction module



Axial persuader

22PER01US**

Reduction module



Extension head breaker

22TAB01US*

Reduction module

*Upon request - Delivery time to be confirmed with order.

**Upon request - Delivery time to be confirmed with order. Up to 2 instruments upon request.

A series of horizontal dashed lines for writing notes.

Corporate Headquarters:

ALPHATEC SPINE, INC.
5818 El Camino Real
Carlsbad, CA 92008 - USA
TL +1 460 431 9286
www.alphatecspine.com

International Headquarters:

SCIENT'X-ALPHATEC SPINE
22 avenue Jean Bart
78960 VOISINS-LE-BRETONNEUX - FRANCE
TL +33 (0)1 39 30 69 30 - FX +33 (0)1 30 43 82 77
www.scientx.com - www.alphatecspine.com

This product is not available for sale in the United States of America
Non contractual pictures.
Please read carefully the instructions for use bulletin.
Devices may be subject to modification. Patented.

Scient'x[®] α Alphatec Spine[®]
Solutions for the Aging Spine[®]

Isobar and the Scient'x-Alphatec Spine logo are registered trademarks of Alphatec Spine. © 2010 Alphatec Spine, Inc. All rights reserved.



DOMKT501-en rev 2.0/ DMQ #11-290/ Approval date : June 2011