

Avalon™

Occipital Fixation System



SURGICAL TECHNIQUE GUIDE

α

Alphatec Spine®

Solutions for the Aging Spine®



System Features

Unique buttress design simplifies bone graft placement

Three points of plate rotation and translation eases rod placement

Five points of screw fixation to the occiput maximizes bone purchase

Seamless integration with the Solanas® Posterior Cervico-Thoracic Fixation System.

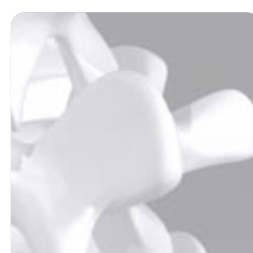
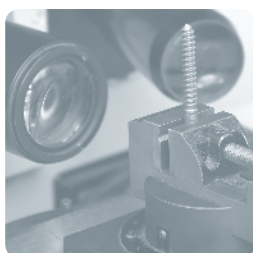



Important Note

As with any surgical procedure, a surgeon should be thoroughly trained before proceeding. Each surgeon must consider the particular needs of each patient and make the appropriate adjustments when necessary.

The Avalon™ Occipital Fixation System must be used in conjunction with Alphatec Spine's SOLANAS Posterior Cervico-Thoracic Fixation System.

Contents

Avalon Implants	4
Surgical Technique	5-10
Avalon Instruments	11-12
Solanas Instruments	13
Product Information	14-15

Plate and Bone Screw Sizes

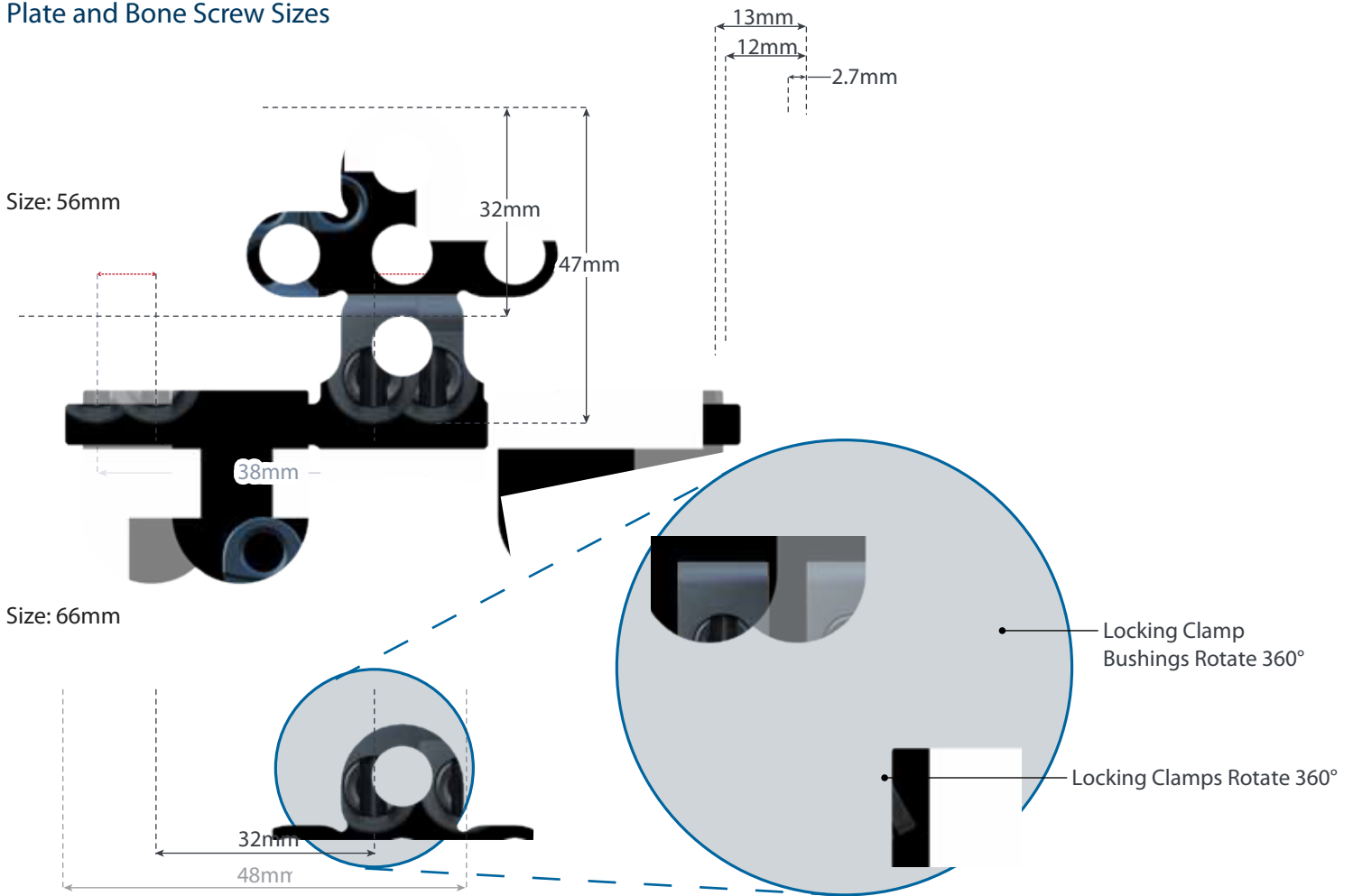

4.5mm Occipital Screw, 12mm

(sizes in millimeters)

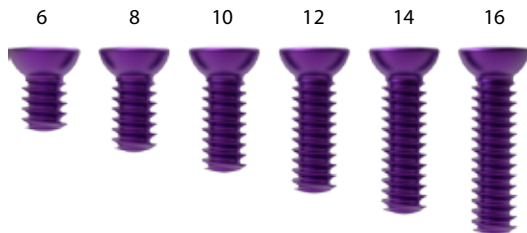

4.5mm

(sizes in millimeters)

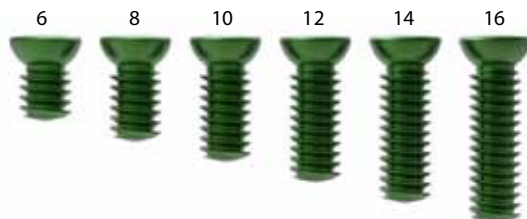

5.0mm

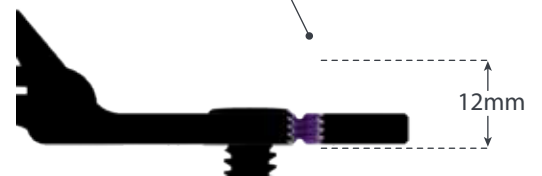

Preoperative Planning and Positioning

The patient should be positioned prone in an appropriate manner per surgeon preference to avoid specific pressure points. Pre-operative sagittal and coronal CTs of the skull are strongly recommended to ascertain skull thickness in relation to plate placement.



Cervical Implant Placement

Select and insert the cervical laminar hooks at the desired levels of fixation (see Solanas Cervico-Thoracic System surgical technique). Rods are recommended to be placed at a later stage of the surgical technique.

Bone Graft Placement

The bone graft can be either structural autogenous graft or freeze-dried allograft. The graft area should be measured from the occiput of the skull to the spinous process of C2. The bone graft should be cut and trimmed using a high-speed burr to ensure that it will lay flat against the occiput and precisely fit over the base of the spinous process of C2 and the C2 lamina. The bone graft must be in final placement before drilling into the skull and securing the occipital plate to the skull is initiated.

External Occipital Protuberance (EOP) ——— Posterior Border of Foramen Magnum

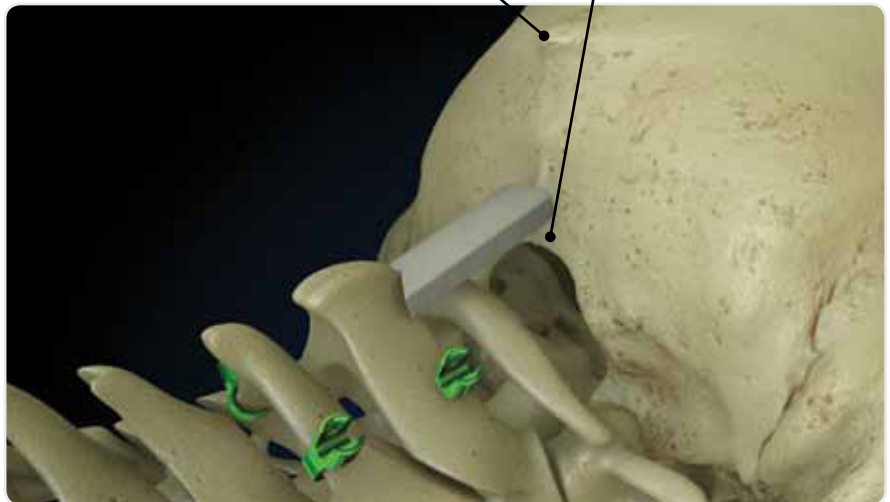

Occipital Plate Placement

In general, the thickest bone in the sub-occipital region is the occipital keel (internal occipital protuberance) in the midline. When positioning the Occipital Plate, it should be centered in the midline between the External Occipital Protuberance (EOP) and the posterior border of the Foramen Magnum. The goal is to maximize bone purchase (closer to EOP) while maintaining a low profile. The keel of the occipital plate must abut against the bone graft to hold it in place and to compress it against the lamina of C2.

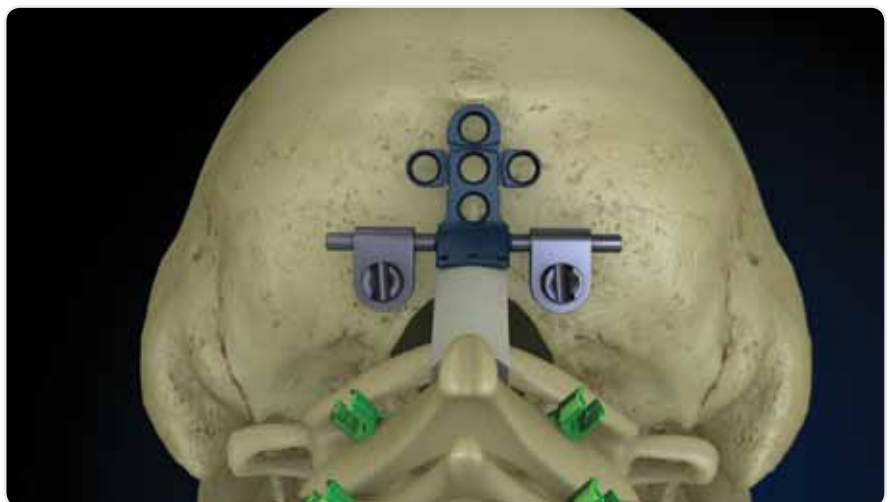

Note: The Plate Rotating Body Adjustment Tool can be used to fine tune the positioning of the saddles.

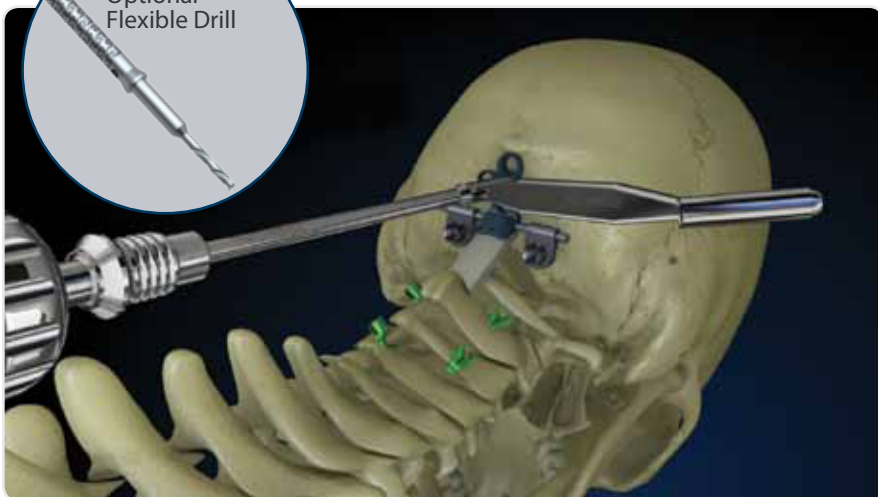

Occipital Plate Contouring

If necessary, the plate can be contoured using the Plate Benders for a more anatomic fit against the occiput. Repeated bending should be avoided as it may compromise the integrity of the implant. It may be necessary to contour a small portion of uneven occipital bone with a high-speed burr (not included) to allow the plate to lie flush.

Caution: The crossbar of the plate should not be bent.

Drilling

Select the appropriate Drill-Tap (DT) Guide based on the desired drilling depth. The DT Guides are available with fixed drilling depths from 6mm to 16mm in 2mm increments. Using the DT Guide to align the drill hole in the Occipital Plate, insert the Straight or Flexible Drill Bit through the DT Guide and drill to the desired depth. It is recommended to start with the 6mm drill and then to sound the hole with a ball tip probe. Repeat process to achieve the optimal depth.

Note: It is recommended drilling be done through the plate.

Note: Both the Straight and Flexible Drill Bits must be used in conjunction with the DT Guide to achieve a fixed drilling depth. When the flexible drill bit is used, the DT Guide will help stabilize the flexible shaft and direct the drill bit in the proper position.

Screw Measurement

The Solanas Depth Gauge should be used to verify the hole depth as well as the occipital bone thickness.



Tapping

Once a satisfactory depth has been achieved, the appropriate Straight or Flexible Tap can be used to prepare the screw hole. Select the appropriate DT Guide based on the desired tapping depth. Insert the Straight or Flexible Tap through the DT Guide and tap to the desired depth. The occipital bone is very dense and each hole should be tapped to the desired screw length.

Note: Both the Straight and Flexible Taps must be used in conjunction with the DT Guide to achieve a fixed tapping depth. When the Flexible Tap is used, the DT Guide will prevent excessive motion of the flexible shaft and help direct the tap in the proper position.

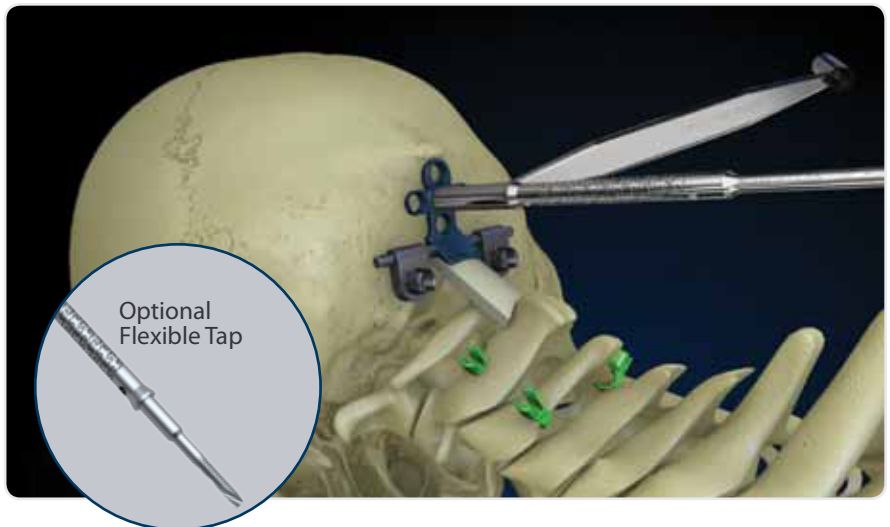

Occipital Bone Screw Insertion

Choose the appropriate diameter and length screw for each screw location and verify the size before placement. Use the Self-Retaining Screwdriver to engage the bone screw, insert it into the occipital bone, and provisionally tighten. The Angled Self-Retaining Screwdriver may also be used for screw insertion.

The remaining screws can be placed using the same technique. Once all of the screws have been placed, use the Self-Retaining Screwdriver or the Angled Self-Retaining Screwdriver for final tightening.

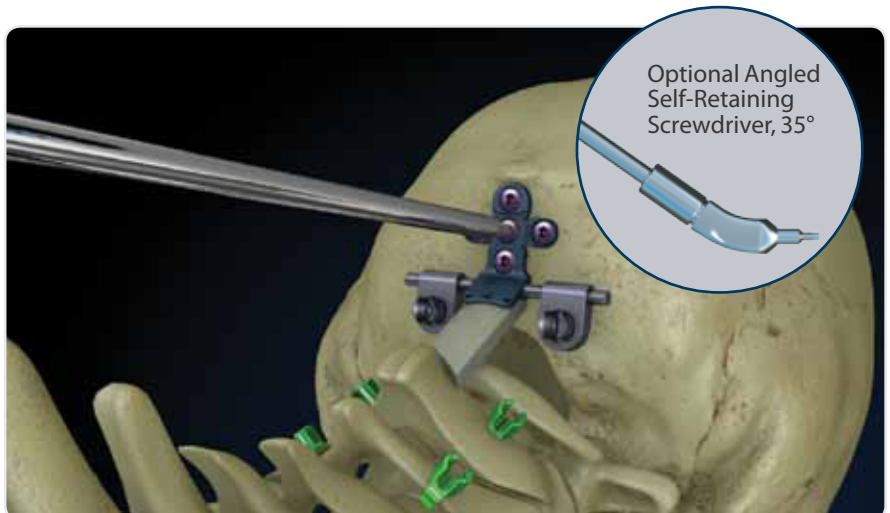



Rod Contouring

If necessary, use the Rod Bender to contour the Precontoured Transition Rod further to best fit the individual patient anatomy. Once the angle and position of the Transition Rod have been determined, cut both ends of the rod to the required length using the Rod Cutter.

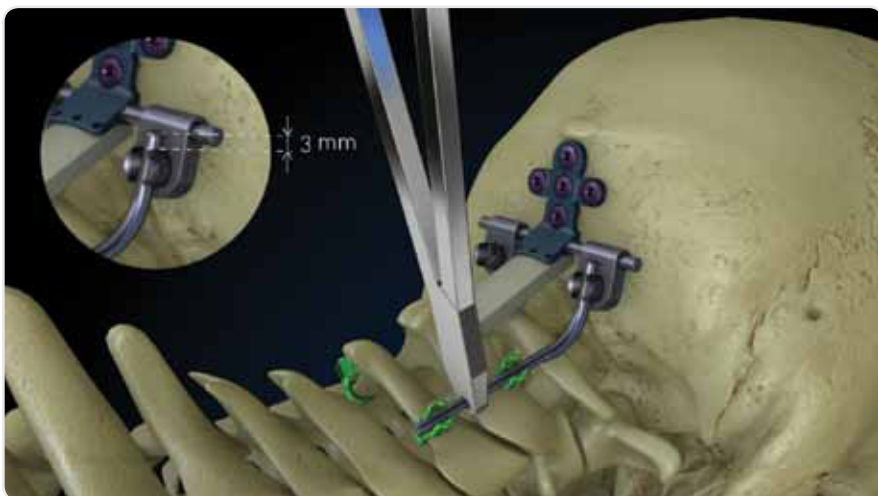

Rod Placement

Use the Rod Holder to position the Occipital Precontoured Transition Rod. Determine the necessary adjustments required to align the rods with the laminar hooks and rod saddles on the Occipital Plate. A rod template is available in the Solanas System.

Note: Ensure the rod is long enough to clear the saddle of the locking clamp on the Occipital Plate by approximately 3mm.

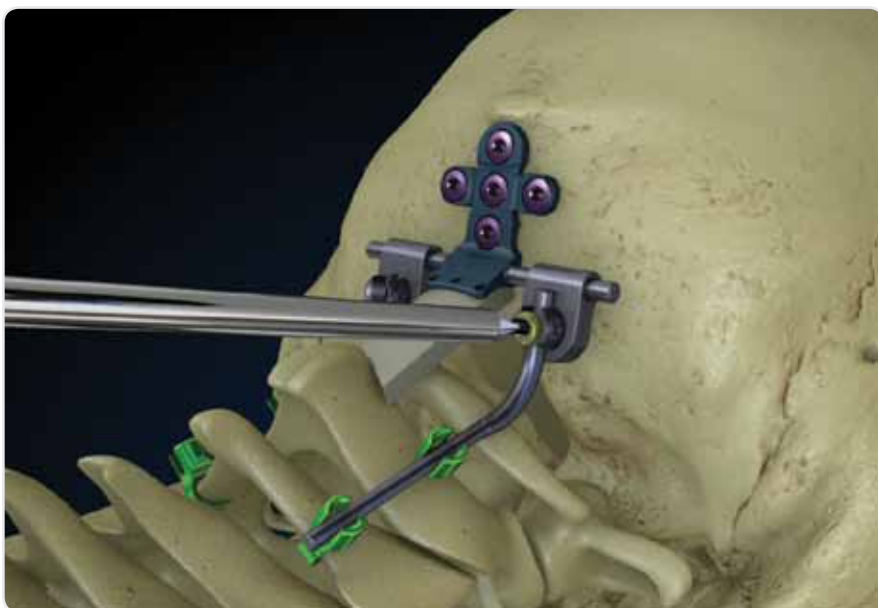

Provisional Tightening of Construct

Once all of the Occipital Bone Screws have been final tightened and the rods have been adjusted to match the patient's anatomy, use the Self-Retaining Screwdriver to provisionally tighten the set screws in the saddles of the Occipital Plate to stabilize the rod. The Angled Self-Retaining Screwdriver may also be used to insert the set screw. Use the Solanas Set Screw Inserter to provisionally tighten the set screws in the laminar hooks.

Note: The Plate Rotating Body Adjustment Tool can be used to fine tune the positioning of the saddles.

In-situ Rod Bending

If the rod needs to be contoured further, left and right In-situ Rod Benders can be used.

Graft Compression

The Occipital Compressor should be used to compress the bone graft between the Occipital Plate/ Occiput and the C2 spinous process and lamina. Loosen the set screws on the cervical hooks to allow the rod to slide freely. Place the Occipital Compressor onto the rod above the Occipital Plate saddle and below the lowest hook and squeeze the handles until desired compression is achieved. Provisionally tighten the set screws.

Caution: The surgeon must exhibit care to avoid impacting the bone graft into the spinal canal.

Holes are provided as a design feature on the keel at the caudal end of the plate. These holes are provided to facilitate placing wires* from the plate to C2 as an additional fixation for the bone graft. Use of such wire is at the surgeon's discretion. The wiring technique chosen is at the discretion of the surgeon based on local anatomy, previous deformity/trauma and desired construct formation.

*Titanium wires or cables are recommended to mitigate risks of Galvanic Reaction.



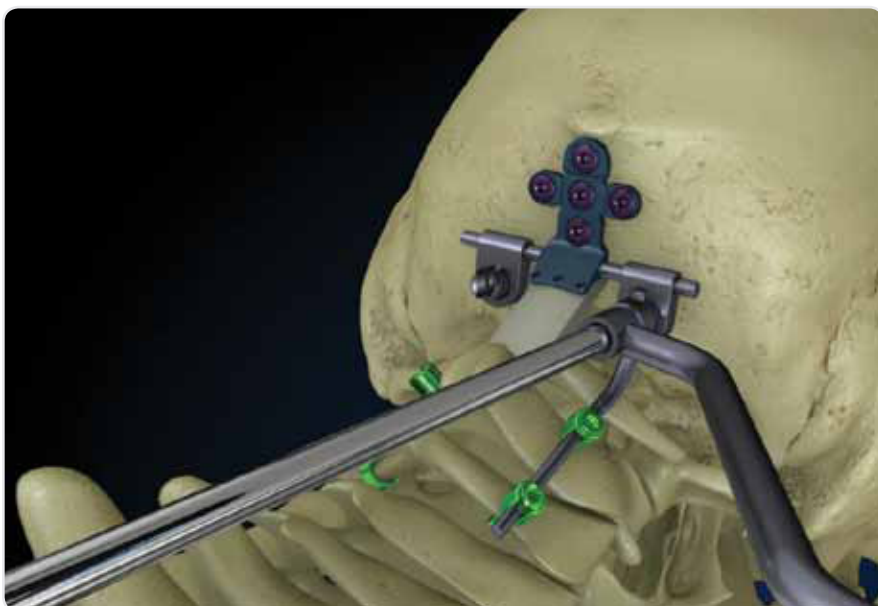

Final Tightening of Construct

After all of the set screws have been placed and the rods are secured in the implants, use the Self-Retaining Screwdriver and the Torque-Limiting handle (25 in-lbs) in conjunction with the Counter Torque Device to final tighten the set screws in the saddles of the plate. The Angled Self-Retaining Screwdriver may also be used for final tightening of the set screws. Set screws in the laminar hooks should also be final tightened using the Solanas Set Screw Driver Shaft and the Solanas Torque-Limiting Handle (25 in-lbs) in conjunction with the Solanas Counter Torque Device.

Caution: It is important to use the supplied torque limiting instrument in accordance with the surgical technique to ensure sufficient torque is applied to the set screw and the associated connector. Failure to tighten the set screw to the recommended torque could compromise the mechanical stability of the connector.

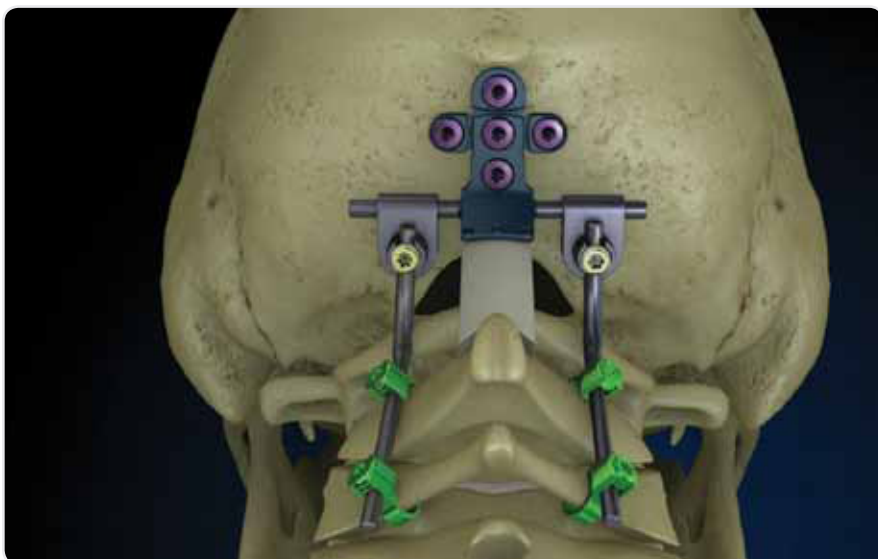

Final Construct

Recheck all connections of the final construct prior to wound closure.

Revision and Removal

To remove any of the Avalon system implants described throughout the technique, engage the set screw with the Self-Retaining Screwdriver and turn counter-clockwise until the set screw is disengaged from the implant and the bone screw is disengaged from the bone. The implants can then be freely removed from the bone.

See Solanas surgical technique for revision and removal of cervical hooks.



Plate Holder

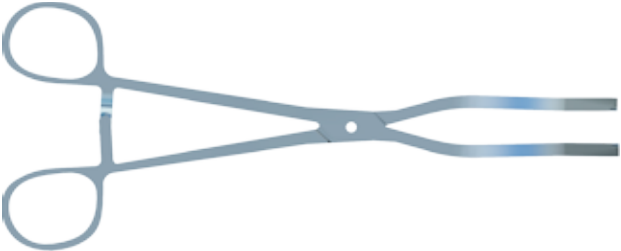

Rod-Bender, 3.3mm and 4.0mm

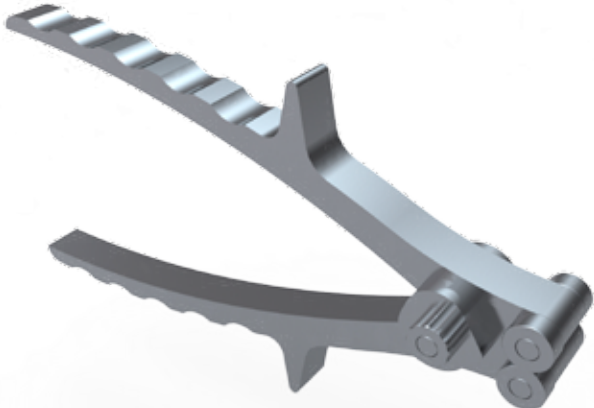

Rod Cutter, 3.3mm and 4.0mm



Plate Benders

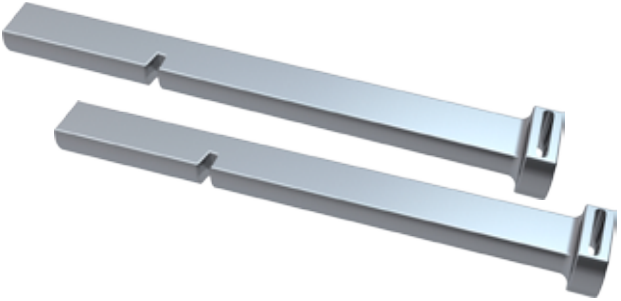

Double Barrel Drill/Tap Guide, 6-16mm in 2mm increments



Straight Drill, 3.2mm



Flexible Drill, 3.2mm



Straight Tap, 4.5mm



Flexible Tap, 4.5mm



Self Retaining Screwdriver



Angled Self Retaining Screwdriver, 35°

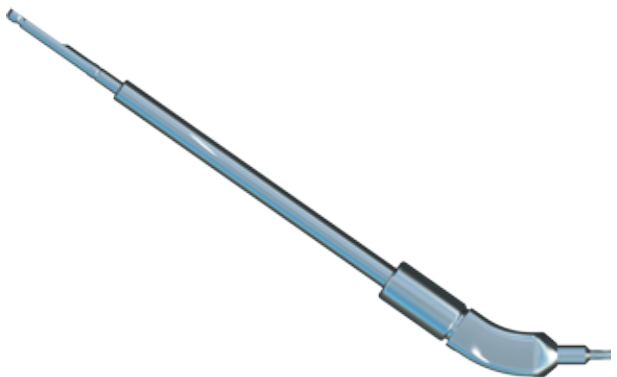
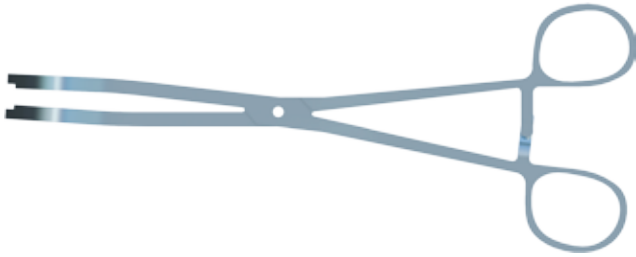

Plate Rotating Body Adjustment Tool



Quick Connect Silicone Axial Handle, Ratcheting



In-situ Rod Bender, left and right



Quick Connect Silicone T-Handle, Ratcheting



Counter-torque



Torque Limiting Silicone Handle, Axial 25inch-lbs



Occipital Compressor

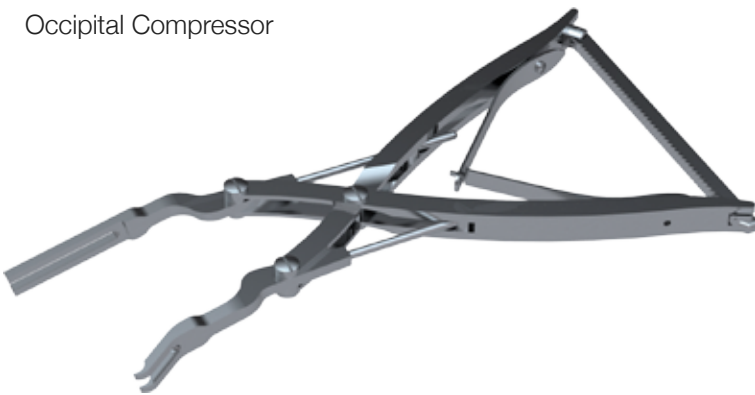

Self-Centering Set Screw Inserter



Rod Persuader



Torque Limiting Handle



Torque Limiting Shaft



Counter-torque



Small Depth Gauge



150mm Rod Template 3.0mm



Hook Trial



Hook Impactor

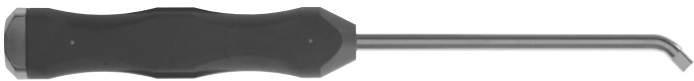

Hook Holder

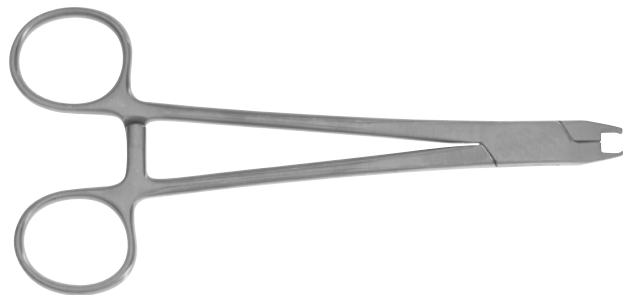

AVALON™ Occipital Fixation System

GENERAL INFORMATION:

The AVALON Occipital Fixation System facilitates the surgical correction of spinal deformities by providing temporary internal fixation and stabilization during bone graft healing and/or fusion mass development. Device implants include a range of sizes of bone screws, hooks, rods, plates, and bridge assemblies to provide the versatility required for the specific conditions listed in the INDICATIONS section.

The components in the AVALON System can be linked to the components in the Solanas Cervico-Thoracic Spinal Fixation System offered by Alphatec Spine using the axial rod connectors, parallel rod connectors or transitional rods.

The implants are manufactured from surgical grade commercially pure titanium (conforming to ASTM F67) or titanium alloy (conforming to ASTM F136) with an electrolytic conversion coating. When used in the occipito-cervico-thoracic spine, the AVALON Occipital Fixation System may be used from the occiput to T3.

It is intended that the implants be removed after successful fusion.

WARNINGS:

1. The safety and effectiveness of pedicle screw spinal systems have been established only for spinal conditions with significant mechanical instability or deformity requiring fusion with instrumentation. These conditions are significant mechanical instability or deformity of the thoracic spine secondary to degenerative spondylolisthesis with objective evidence of neurologic impairment, fracture, dislocation, scoliosis, kyphosis, spinal tumor, and failed previous fusion (pseudoarthrosis). The safety and effectiveness of these devices for any other conditions are unknown.
2. The AVALON Occipital Fixation System is an implant device used only to provide temporary internal fixation during the bone fusion process with the assistance of a bone graft. A successful result may not be achieved in every instance of use with this device.
3. The benefit of spinal fusions utilizing any pedicle screw fixation system has not been adequately established in patients with stable spines.
4. This product is a single use device. Under no circumstances should it be reused. While the device may appear to be undamaged, it may have small defects or internal stress patterns, as a result of the prior implantation or removal that could lead to fatigue failure. Additionally, please note that the removed implant has not been designed or validated so as to allow for decontamination of microorganisms. Reuse of this product could lead to cross-infection and/or material degradation as a result of the decontamination process. The company accepts no responsibility for products which have been reused.
5. Without solid bone fusion, this device cannot be expected to support the spine indefinitely and may fail due to bone-metal interface, rod failure or bone failure.
6. Based on testing, results from this system are significantly affected by the surgeon's proper patient selection, preoperative planning, proper surgical technique, proper selection and placement of implants, proper reduction and complete compliance of the patient.
7. Potential risks identified with the use of this device, which may require additional surgery, include device component fracture, loss of fixation, non-union, fracture of the vertebra, neurological injury, and vascular or visceral injury.
8. Patients who smoke should be advised of the consequences associated with the fact that an increased incidence of non-union has been reported with patients who smoke.
9. Other significant risks to spinal surgery include alcohol abuse, obesity, and/or patients with poor bone, muscle and/or nerve quality.
10. It is critical that the setscrews are turned to the proper torque values recommended in the surgical technique with the instruments provided. It is important to use the supplied torque limiting instrument in accordance with the surgical technique to ensure sufficient torque is applied to the set screw and associated connector. Failure to tighten the set screw to the recommended torque could compromise the mechanical stability of the connector.
11. The implants and instruments are provided non-sterile and must

be cleaned and sterilized before use. Validated sterilization cycle parameters are provided in the STERILIZATION/ RESTERILIZATION section of this IFU.

12. The AVALON Occipital Fixation System has not been evaluated for safety and compatibility in the MR environment. The AVALON Occipital Fixation System has not been tested for heating or migration in the MR environment.

INDICATIONS:

The AVALON Occipital Fixation System is intended to promote fusion of the cervical spine and the occipito-cervico-thoracic junction (occiput-T3). It is intended that this device, in any system configuration, be removed after development of solid fusion mass. The occipital bone screws are limited to occipital fixation only. Hook components are indicated for use at C1-C7. Polyaxial pedicle screws are intended for placement only in T1-T3 for anchoring of the system. These screws and offset connectors are not intended to be placed in the cervical spine. The components in the Solanas Posterior Fixation System can be linked to the components in the Zodiac Polyaxial Spinal Fixation System offered by Alphatec Spine using the axial rod connectors, parallel rod connectors or transitional rods. However, the components of the AVALON Occipital Fixation System are not intended to work with the Zodiac System.

It is intended for the following:

1. Degenerative disc disease (DDD), defined as neck pain of discogenic origin with degeneration of the disc confirmed by history and radiographic studies.
2. Spondylolisthesis.
3. Spinal stenosis.
4. Fracture/Dislocation.
5. Atlanto/Axial fracture with instability.
6. Revision of previous cervical spine surgery.
7. Tumors.
8. Occipito-cervical dislocation.

CONTRAINDICATIONS:

The AVALON Occipital Fixation System is contraindicated for:

1. Use in the thoracic-lumbo-sacral spine below T3.
2. Patients with osteopenia, bone absorption, bone and/or joint disease, deficient soft tissue at the wound site or probable metal and/or coating intolerance.
3. Patients with infection, inflammation, fever, elevated white blood count, obesity, pregnancy, mental illness and other medical conditions, which would prohibit beneficial surgical outcome.
4. Spinal surgery cases that do not require bone grafting and/or spinal fusion.
5. Use with bone cement.
6. Patients resistant to following post-operative restrictions on movement especially in athletic and occupational activities.
7. Use with stainless steel components.
8. Reuse or multiple uses.
9. Patients resistant to following post-operative instruction.

POSSIBLE ADVERSE EFFECTS:

The following complications and adverse reactions have been shown to occur with the use of similar spinal instrumentation. These effects and any other known by the surgeon must be discussed with the patient preoperatively.

1. Initial or delayed loosening, disassembly, bending, dislocation and/or breakage of device components.
2. Physiological reaction to implant devices due to foreign body intolerance including inflammation, local tissue reaction, and possible tumor formation.
3. In the case of insufficient soft tissue at and around the wound site to cover devices, skin impingement and possible protrusion through the skin may occur.
4. Loss of desired spinal curvature, spinal correction and/or a gain or loss in height.
5. Infection and/or hemorrhaging.
6. Bone graft, vertebral body fracture, and/or discontinued growth of



fused bone at, above and/or below the surgery level.

7. Non-union and/or pseudoarthrosis.
8. Neurological disorder, pain and/or abnormal sensations.
9. Inability to perform routine activities.
10. Revision surgery.
11. Death.

PRECAUTIONS:

1. Based on the fatigue test results, the physician/surgeon should consider the levels of implantation, patient weight, patient activity level and patient condition, which may impact on the performance of the system when using this device.
2. The implantation of pedicle screw spinal systems should be performed only by experienced spinal surgeons with specific training in the use of this pedicle screw spinal system because this is a technically demanding procedure presenting a risk of serious injury to the patient.

COMPLAINT HANDLING/REPORTING:

All product complaints relating to safety, efficacy or performance of the product should be reported immediately to Alphatec Spine by telephone, fax, or letter. All complaints should be accompanied by name, part number, and lot numbers. The person formulating the complaint should provide their name, address, and as many details as possible.

Caution: Federal law (USA) restricts these devices to sale by or on the order of a physician.

