

# ▲.U.S.T. PERCUTANEOUS

MINIMALLY INVASIVE SOLUTIONS

A FURTHER STEP FOR WELL-ESTABLISHED MIS PLATFORM

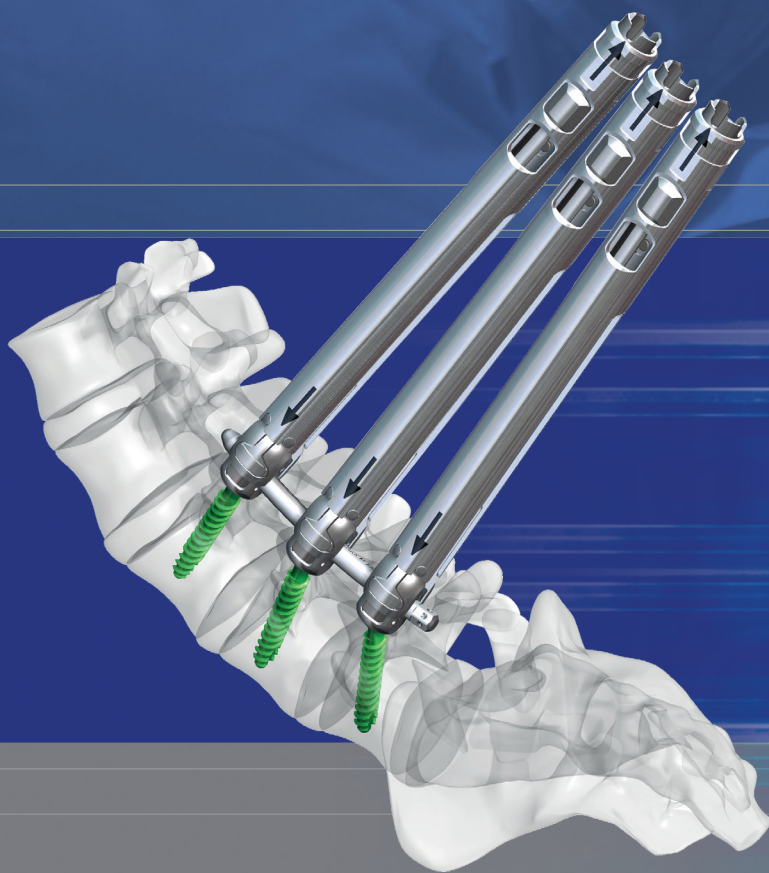

## Surgical Technique

Joint

Spine

Sports Med



## INDEX

<b>1. INTRODUCTION</b>	<b>4</b>
1.1 Indications	5
1.2 Contraindications	5
1.3 Pre-Operative Planning	5
1.4 Surgical Approach	5
<b>2. MIS PERCUTANEOUS SURGICAL STEPS</b>	<b>6</b>
2.1 Pedicle Preparation	6
2.2 Tapping	7
2.3 Screw Insertion	7
<b>3. ROD INSERTION</b>	<b>10</b>
3.1 Rod Sizing	10
3.2 Rod Selection	10
3.3 Rod Insertion	10
3.4 Rod Verification	12
3.5 Rod Locking	12
<b>4. FINAL CONSTRUCTION</b>	<b>13</b>
4.1 Rod Reduction and Set Screw Insertion	13
4.2 Compression or Distraction	14
4.3 Final Tightening	16
4.4 Tower removal	16
<b>5. RESCUE INSTRUMENT</b>	<b>18</b>
<b>6. IMPLANTS NOMENCLATURE</b>	<b>19</b>

## 1. INTRODUCTION

The Medacta MIS Percutaneous System is designed to provide the surgeon with a minimally invasive solution for spinal thoracolumbar fixation. The system is able to deliver several advantages for patients including smaller incisions and minimal muscle resection, reduction of blood loss and post-operative pain, precision and efficiency in pedicle screw placement.

### Slim Percutaneous Tubes

- 15mm diameter
- Low profile to minimise muscle trauma
- Dedicated design to perfectly match and firmly anchor the Enhanced Pedicle Screw
- 100mm lateral windows for easy Rod insertion
- 35mm rod reduction capability
- Short version available

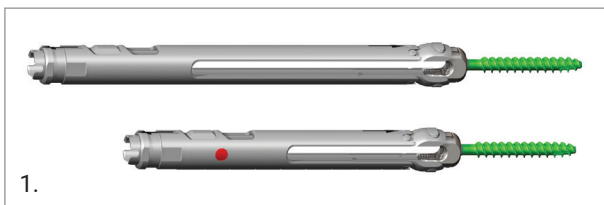

### Cannulated Polyaxial Pedicle Screw

- Range of motion of 60° to facilitate the connection of the Percutaneous Tubes
- Dual lead thread to secure optimal bone purchase
- Low profile tulip to minimise the implant height over the bony elements
- 1.75mm cannulation for safe use with 1.5mm K-wire



### MIS Rods

- Bullet nose profile to ease navigation through soft tissues
- Hexagonal interface to help insert the rod in a lordotic, kyphotic or lateral manner.
- Available in different designs:

- Straight Rods
- Bent Rods, with standard pre-lordosed curvature (R200)
- Bent Rods R100, with increased lordosis to treat the short lumbar tracts
- Dual Bent Rods, with an enhanced proximal lordosis to match the sacrum and a standard distal curvature to treat the lumbar spine

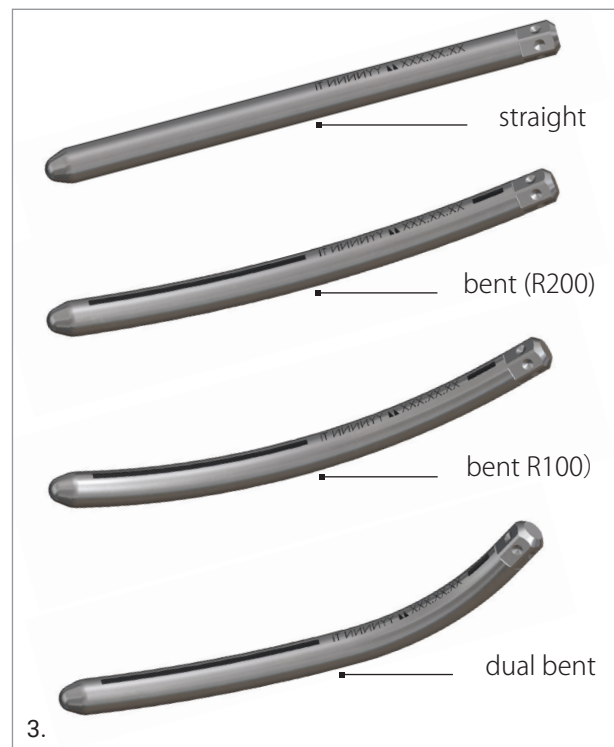

## 1.1 INDICATIONS

The M.U.S.T. Pedicle Screw System is intended for posterior non-cervical pedicle fixation (T1-S2/ilium) and non-pedicle fixation or anterolateral fixation (T8-L5). These devices are indicated as an adjunct to fusion for all of the following indications: degenerative disc disease (defined as back pain of discogenic origin with degeneration of the disc confirmed by history and radiographic studies); spondylolisthesis; trauma (i.e., fracture or dislocation); spinal stenosis; curvatures (i.e., scoliosis, kyphosis, and/or lordosis); tumor; pseudoarthrosis and failed previous fusion in skeletally mature patients.

When used for posterior non-cervical pedicle screw fixation in pediatric patients, the M.U.S.T. implants are indicated as an adjunct to fusion to treat adolescent idiopathic scoliosis. The system is intended to be used with autograft and/or allograft. Pediatric applications are limited to a posterior approach.

## 1.2 CONTRAINDICATIONS

The use of the M.U.S.T. Pedicle Screw System is contraindicated in the following cases:

- Active infectious process or significant risk of infection (immunocompromised hosts).
- Signs of local inflammation.
- Fever or leukocytosis.
- Morbid obesity.
- Mental illness.
- Grossly distorted anatomy caused by congenital abnormalities.
- Any other medical or surgical condition which would preclude the potential benefit of spinal implant surgery, such as the presence of congenital abnormalities, elevation of sedimentation rate unexplained by other diseases, elevation of white blood count (WBC), or a marked left shift in the WBC differential count.
- Suspected or documented metal allergy or intolerance.
- Any case not needing a bone graft and fusion.

- Any case where the implant components selected for use would be too large or too small to achieve a successful result.
- Any patient having inadequate tissue coverage over the operative site or inadequate bone stock or quality.
- Any patient in which implant utilisation would interfere with anatomical structures or expected physiological performance. Any patient unwilling to follow post-operative instructions.
- Any case not described in the indications.

## 1.3 PRE-OPERATIVE PLANNING

Review the MRI and/or CT based imaging to template and determine the type/size of the implants to be used. Matching the patient's anatomy is a critical step in the pre-operative planning before each surgery.

## 1.4 SURGICAL APPROACH

The M.U.S.T. Pedicle Screw System is designed with the focus on spinal fixation, providing the surgeon with different possible surgical approaches.

The current surgical technique describes all the steps to be taken with a Posterior MIS Percutaneous Approach. The other posterior approaches are Midline, Wiltse and Mini-Open.

The different Anterior/Lateral approaches are Laparoscopic, Open or Mini-Open. Surgeons would use the retroperitoneal or the trans-psoas technique.

The construct is assembled in the same way as the posterior approach, the screws however are placed directly in the vertebrae, instead of the pedicles.

## 2. MIS PERCUTANEOUS SURGICAL STEPS

The patient should be positioned prone lying face down on a radiolucent table. Perform a posterior incision through the skin and fascia approximately 2 - 4 cm from the midline to allow for muscle splitting along the multifidus and longissimus plane.

### 2.1 PEDICLE PREPARATION

Assemble the cannulated awl with the handle and the inner pin.

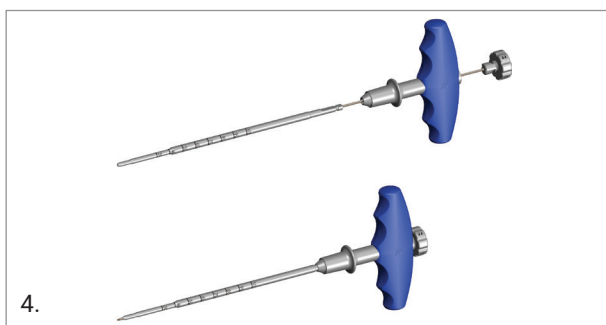

Target the pedicle and perforate the outer cortex with the Cannulated Awl.

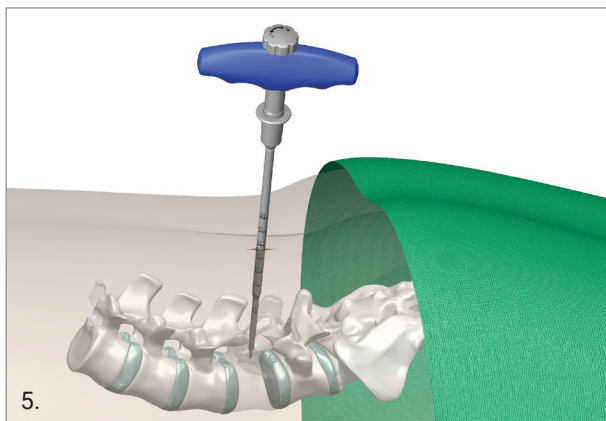

#### WARNING

Confirm the pedicle anatomical positioning with radiographic imaging.

Remove the inner pin and the handle from the Cannulated Awl and insert the Kirschner wire, carefully inserting it through the incision.

#### WARNING

Control the K-Wire position under radiographic imaging and make sure it does not slip off during the procedure.

Markings on the wire designate 5mm increments, and can be used to determine penetration depth. Additionally, the depth markers can be used to monitor unintentional guidewire advancement or rotation.

**NOTE:** A Jamshidi Needle can be used as an alternative to access the pedicle and K-Wire guiding.

**NOTE:** A K-wire holder is available for insertion or removal of the wire itself.

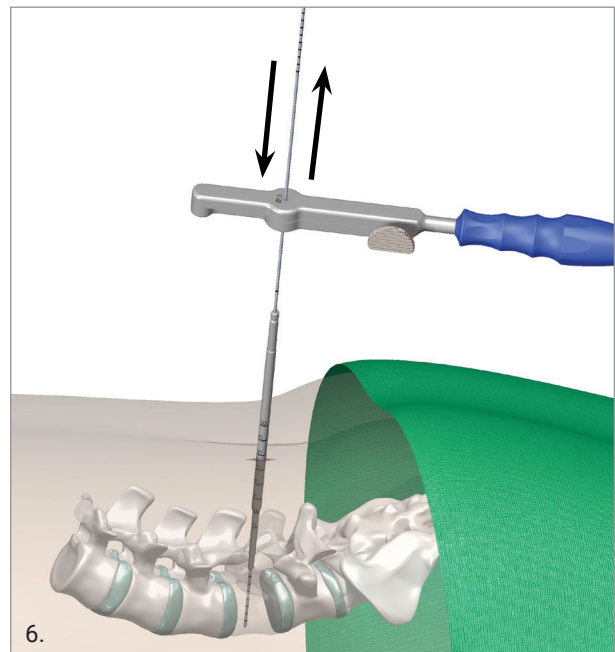

The K-wire holder is used to either advance or remove Kirschner wires during the procedure.

To use the K-wire holder, push the lock button and slide the tool over the Kirschner wire few centimeters above the end of the cannulated awl or Jamshidi needle, then release the locking button. Lightly mallet the impaction surface of the holder to advance the Kirschner wire. Stop impacting before the tool reaches the top of the cannulated awl or Jamshidi needle. Insert all Kirschner wires as required. If further K-wire insertion is needed, after checking fluoroscopy, slide the wire holder back and repeat the manoeuver.

## 2.2 TAPPING

Although MUST enhanced cannulated screws are self-tapping, in some cases a tapping might be necessary. If so, the appropriate size cannulated self-drilling tap is advanced over the guidewire into the pedicle by turning the tap clockwise.

When the tap is used with the Dilator Nr.2, the depth markings on the proximal half of the tap can be used to determine the tap depth and appropriate screw length.

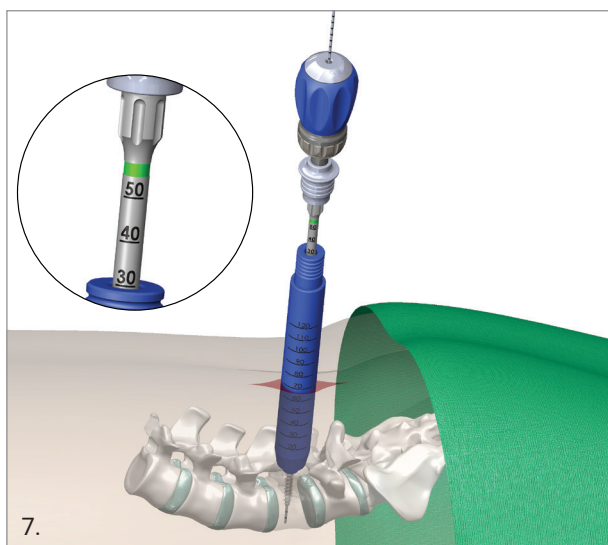

### WARNING

Tapping is mandatory before inserting pedicle screws larger than 7mm in diameter. In case of sclerotic bone, or any other factor that can cause high resistance during screw insertion, apply the same procedure for all the other diameters. Please note that the taps are undersized by 0.5mm.

### WARNING

While tapping, take care to avoid unintentional guidewire advancement or rotation. Do not advance the tap beyond the tip of the guidewire as doing so may result in unintentional wire removal. Use caution not to bend or kink the guidewire while advancing the tap.

It is recommended that fluoroscopy be used while tapping to monitor the depth of the tap and ensure the guidewire is not advanced unintentionally.

## 2.3 SCREW INSERTION

Insert the dilator Nr.1 (1.8/8 mm) over the Kirschner wire. Determine the screw length using the dilator Nr.1. Read off the screw length indicated by the central marking of the 460mm Kirschner wire (or the appropriate marking of the 600mm Kirschner wire).

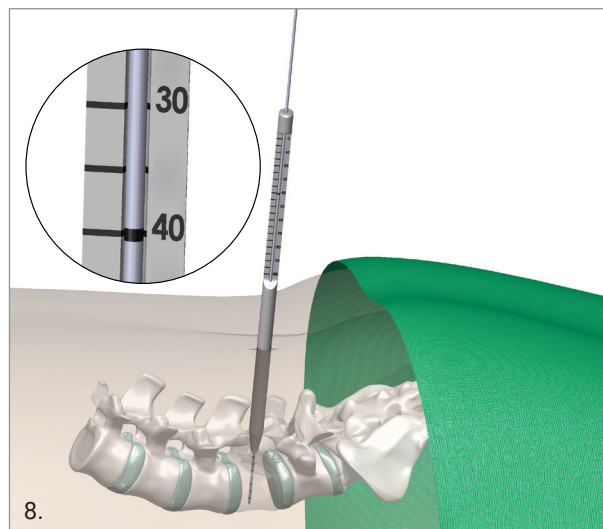

Continue dilation placing dilators Nr.2 (8/17 mm) and Nr.3 (17/22 mm).

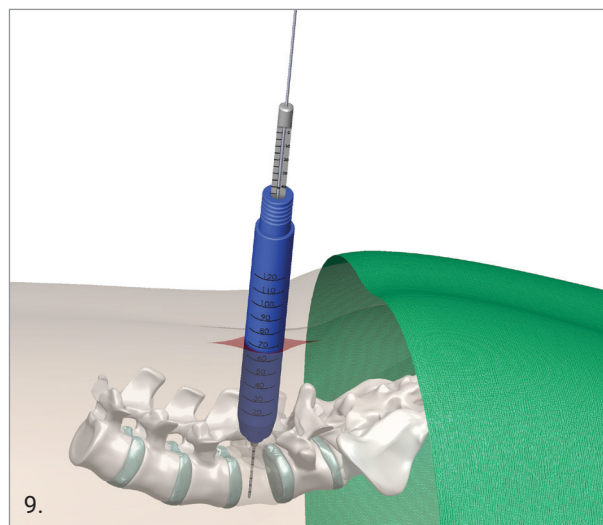

**NOTE:** Use radiographic imaging to confirm orientation and depth of the Kirschner wire while inserting the tubes.

**NOTE:** Ensure the dilator is placed in contact with the lamina. The screw Depth Gauge shows the depth of the Kirschner wire tip starting from the pedicle entry point.

Remove the dilators while carefully holding the Kirschner wire in place to ensure the pedicle entry point for screw placement is maintained.

### WARNING

While removing the dilators secure the Kirschner wire at all times.

**NOTE:** If Kirschner wire is unintentionally removed, use pedicle awl or Jamshidi needle to search for entry point.

**OPTION**

Leave the dilator Nr.3 in place to protect the surrounding tissue while inserting the pedicle screw.

Couple the inner and outer sleeve and set the Percutaneous Tower assembly in the open position as shown in figure by pulling proximally the release button.

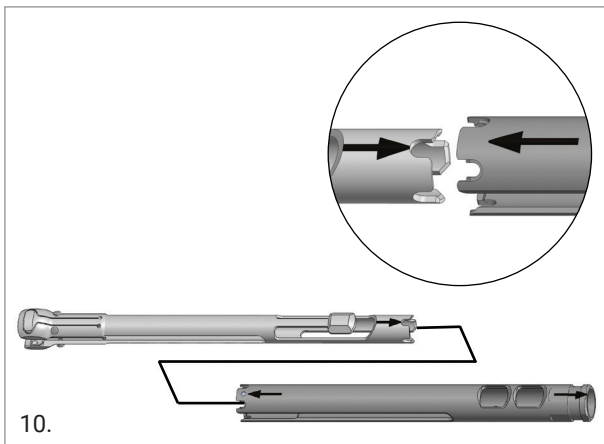

10.

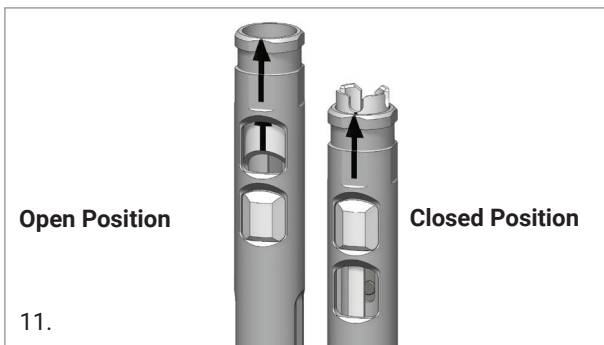

11.

After assembling the Loading Station on its stand, insert the screw into the Loading Station and then insert the Percutaneous Tower through the Loading Station assembly. After checking the proper position of the Tower press down firmly the button to engage the Tower with the screw head. An audible “pop” will signal that the Percutaneous Tower is attached to the screw head.

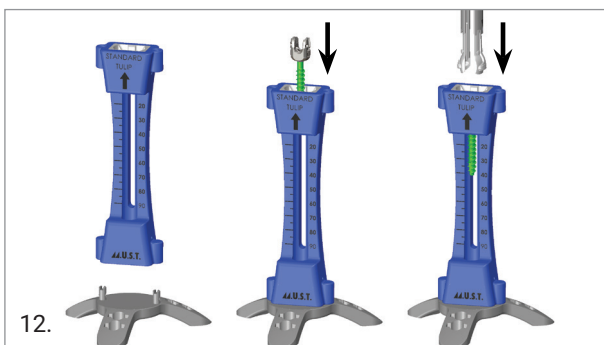

12.

**OPTION**

To facilitate the manipulation of the Percutaneous Tower during the engagement of the pedicle screw, a dedicated handle is provided. Assemble the handle onto the Tower with the “ENGAGE” marking facing the Tower button.



13.

**CAUTION**

The Loading Station has one side for standard tulips (screws up to Ø 7mm included) and one for revision tulips (screws larger than Ø 7mm). (see picture below)

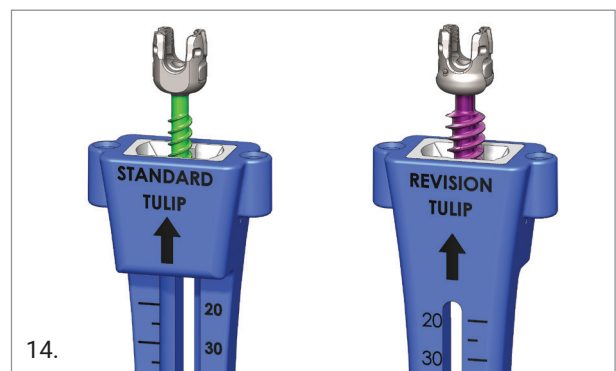

14.

**NOTE:** The loading station stand offers 6 slots to help the engagement of the setscrews to the driver.

Verify the Pedicle Screw is properly engaged with the Percutaneous Tower.

Slide the MIS Poly-Axial Screwdriver into the Percutaneous Tower-Pedicle Screw assembly and couple it with the pedicle screw.

**NOTE:** The correct Pedicle Screw/MIS Poly-Axial screwdriver coupling can be reached after a slight rotation and re-alignment of the screw body.

Tighten the head of the pedicle screw to the Polyaxial Screwdriver by turning the proximal thumbwheel clockwise until the screw is fully tightened.





With the Quick Connect Ratchet Handle in place, drive the Percutaneous Tower-Pedicle Screw assembly over the K-wire and insert the screw percutaneously into the prepared pedicle.

After gaining good bone purchase remove the K-Wire to prevent it from being inserted too far.

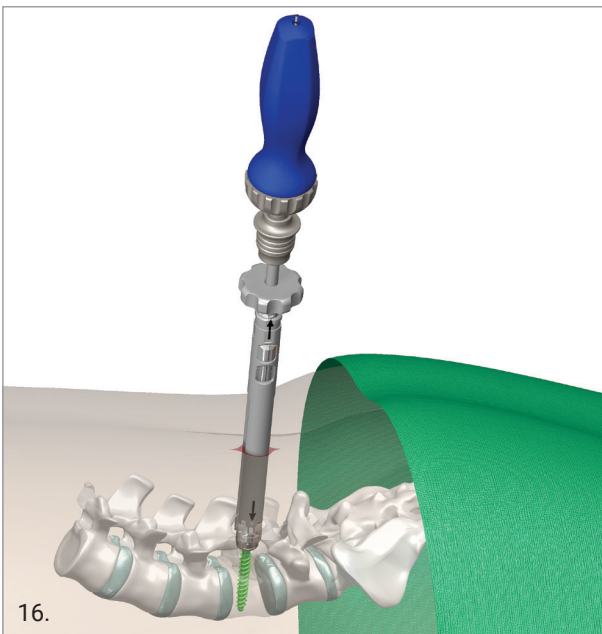

### WARNING

To maintain the polyaxial capability of the Pedicle Screw, the tulip should not be fully seated against the bone. Using fluoroscopy check the correct pedicle screw positioning and also, that the height of the tulip is compatible to accommodate the rod insertion. Do not allow advancement of the K-Wire.

Once the pedicle screw is inserted in the pedicle canal remove the MIS Polyaxial Screwdriver by rotating the proximal thumbwheel counter-clockwise.

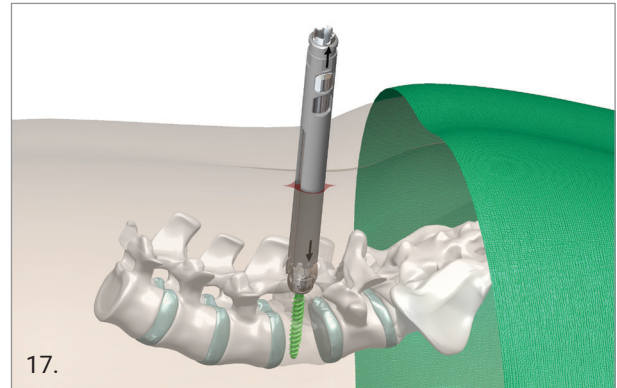

### OPTION

The screw-tower assembly can be inserted either percutaneously, or through the Dilator Nr3. Alternatively, the tower can be assembled with the Tissue Protection Sleeve to minimize the screw incision and protect the soft tissues from the edges of the tower.

The height of each screw must be set appropriately to accommodate the curvature of the rod, further adjustments can be achieved using the bone screwdriver. Screw height can be verified with lateral fluoroscopy or by checking the alignment of the top of the Percutaneous Towers.

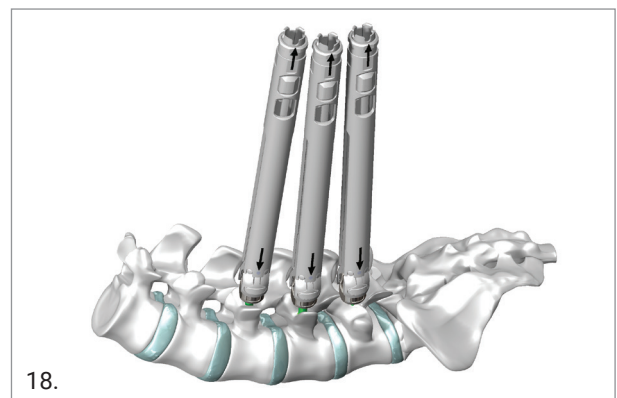

### 3. ROD INSERTION

#### 3.1 ROD SIZING

Place the Rod Gauge into the top cranial and the bottom caudal Percutaneous Tower to measure the length of the rod to be inserted. Ensure the proper engagement of the Rod Gauge extremities into each of the proximal grooves of the Percutaneous Towers extensions.

**NOTE:** The use of the Rod Gauge provides the optimal size of the rod to be implanted, including a limited overhang from the first and last screw. In case of intermediate size measuring, choose the longer rod size.

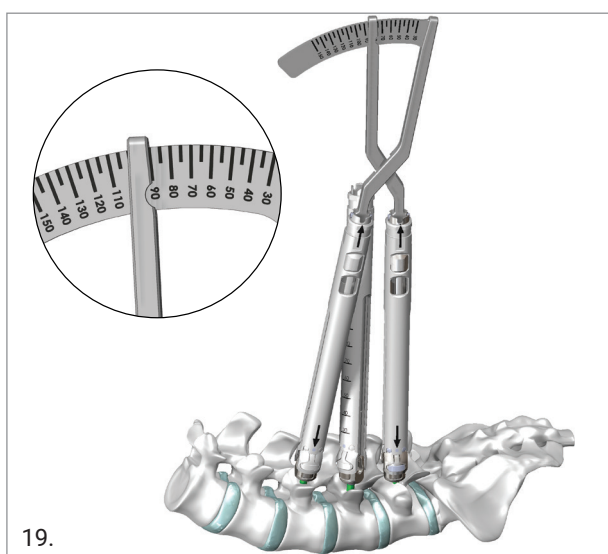

The rod gauge measures up to 150mm. Segments greater than 150mm can be measured by adding multiple measurements together.

#### CAUTION

In case of multiple measurements, subtract 25mm for every segment added to the first one.

**NOTE:** Standard Rod Gauge is not compatible with short Percutaneous Towers. In case short towers are used, use the dedicated rod gauge, identified by red markings.

#### OPTION

Assemble the MIS Soft Tissue Dissector to the Rod Inserter and use it to split the muscles and prepare the path for rod insertion.:

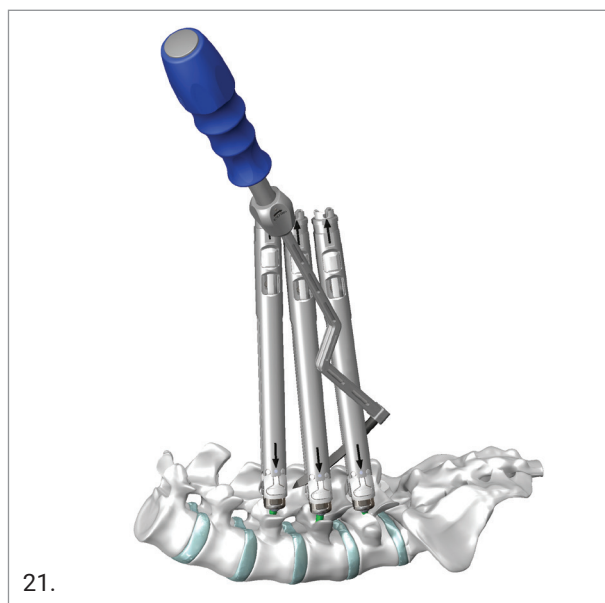

#### 3.2 ROD SELECTION

Select the proper enhanced rod length and contour it to match the patient's anatomy, if necessary.

Assemble the enhanced rod to the Rod Inserter; secure the assembly by rotating clockwise the thumbwheel and verify the stability of the interface.

The hexagonal Rod Inserter interface assures that the rod can be assembled and further inserted in different positions: lordotic, kyphotic or lateral; on the bent rod types, the longitudinal marking indicates the lordotic side.

#### 3.3 ROD INSERTION

After choosing the appropriate rod, insert the connection end of the rod into the pocket of the Rod Holder ensuring that the notch on the connection end of the rod is facing up towards the handle of the Rod Holder. Position the Rod Holder Handle as parallel as possible to the skin surface, with the rod parallel to the axis of the slots of the Tower (perpendicular to the skin).

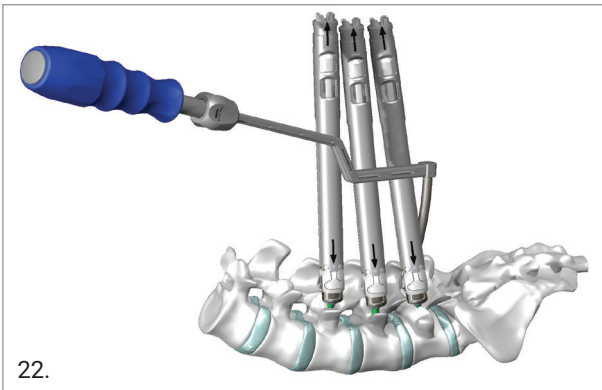

22.

Insert the rod into the cephalad slot of the Tower. The tip of the rod should be contained in the Percutaneous Tower. Advance the distal end of the rod straight down towards the screw until it touches the screw head or is as deep as the tissue will allow. It is necessary for the distal end of the Rod to be below the fascia before proceeding.

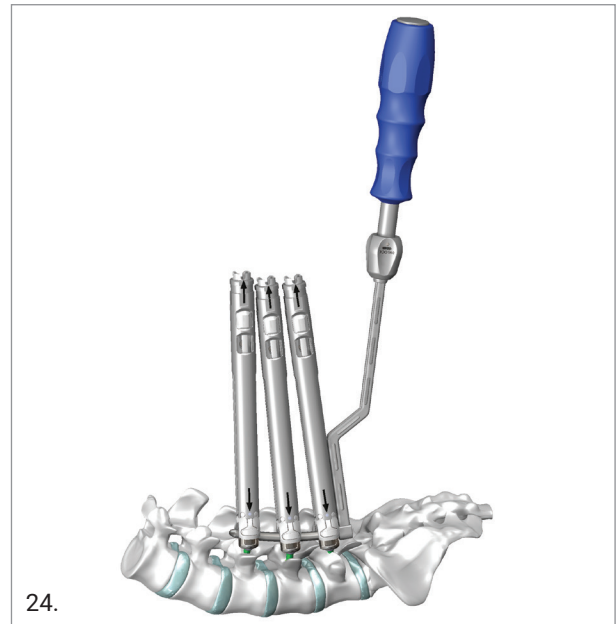

24.

**NOTE:** A Rod Holder without positive stop can be used as an alternative for rod insertion from the inner side of the Towers, according to surgeon's preferences

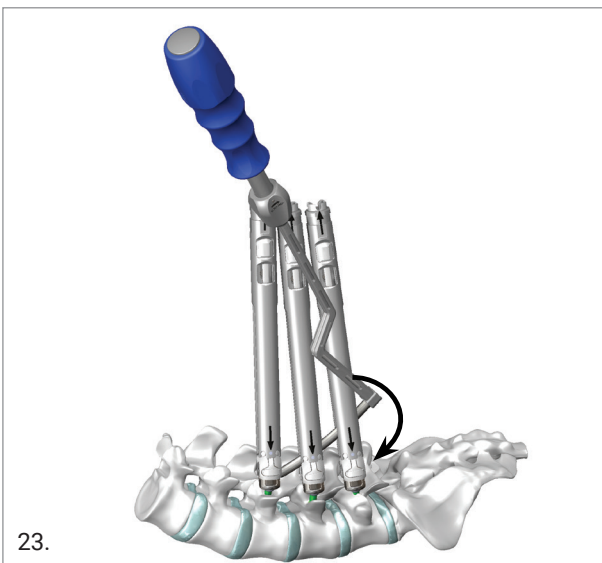

23.

Rotate the handle of the Rod Holder toward the cephalad direction approximately 45°. This action will guide the tip of the rod towards each successive tower.

Continue to advance the rod subfascially into the adjacent towers by moving the Rod Holder towards each subsequent Tower in a linear manner.

A positive stop onto the Rod Holder avoids an excessive introduction of the rod itself.

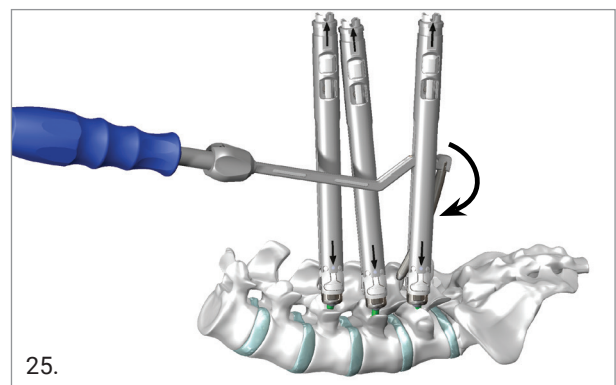

25.

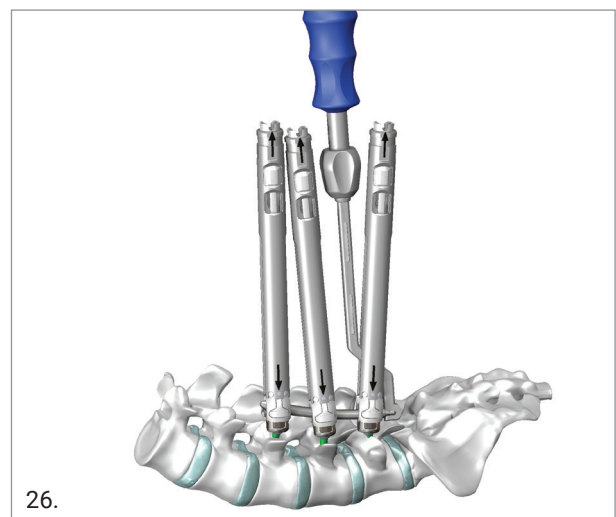

26.

### 3.4 ROD VERIFICATION

Slide the Rod Indicator inside the Percutaneous Tower until the mechanical stop is reached. When the rod is fully seated inside the tulip, the uppermost laser marking is flush with the Tower top. If the Rod Indicator can be pushed further inside the Tower, the rod did not extend into this tulip and rod re-positioning is required. If the rod is located above the tulip, the laser markings will show in millimeters the amount of reduction needed.

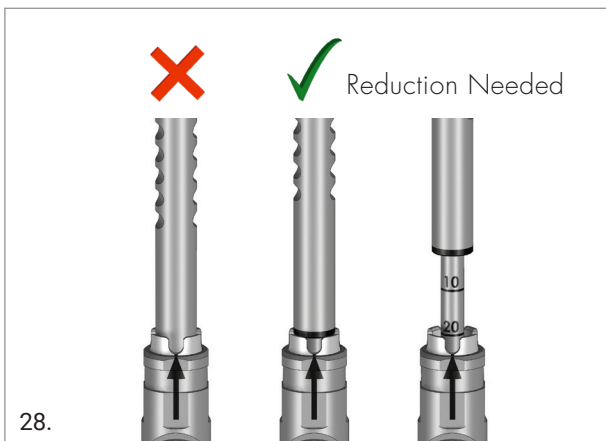
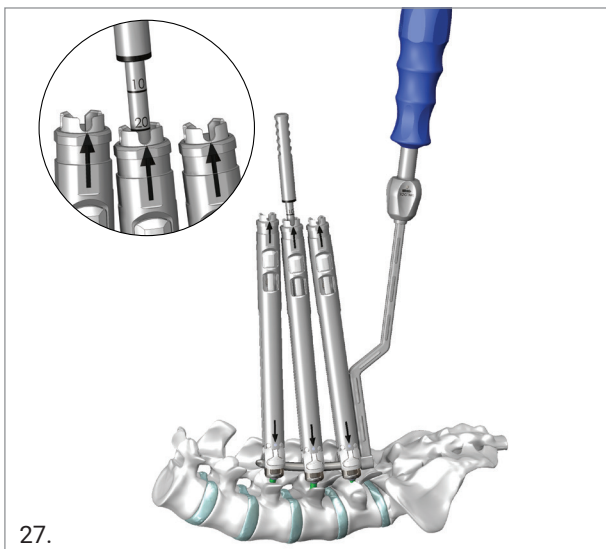

**NOTE:** The Rod Indicator is not compatible with short Percutaneous Towers.

Fluoroscopy can provide further guidance to confirm correct rod insertion.

### 3.5 ROD LOCKING

Using the Temporary Set Screwdriver, preliminarily stabilise the rod into place by tightening at least one set screw at the end of the construct.

The Rod Holder may now be released; gently retract it away from the rod by rotating the thumbwheel counterclockwise.

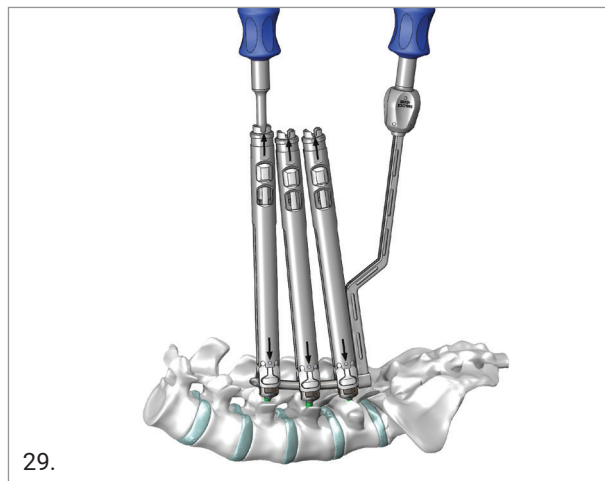

#### **WARNING**

Before removing the Rod Holder, confirm the rod is correctly placed within the cranial and caudal set screw.

**NOTE:** The set screws can be loaded to the temporary set screwdriver using the Loading Station stand.

## 4. FINAL CONSTRUCTION

### 4.1 ROD REDUCTION AND SET SCREW INSERTION

Rod reduction maybe required prior to locking the set screw.

**NOTE:** A reduction of up to 35 mm can be achieved with the Medacta Percutaneous Instrumentation. Use the Rod Indicator to confirm the reduction distance. The reduction pitch is 2mm.

Connect the MIS Reduction Handle to the Percutaneous Tower.

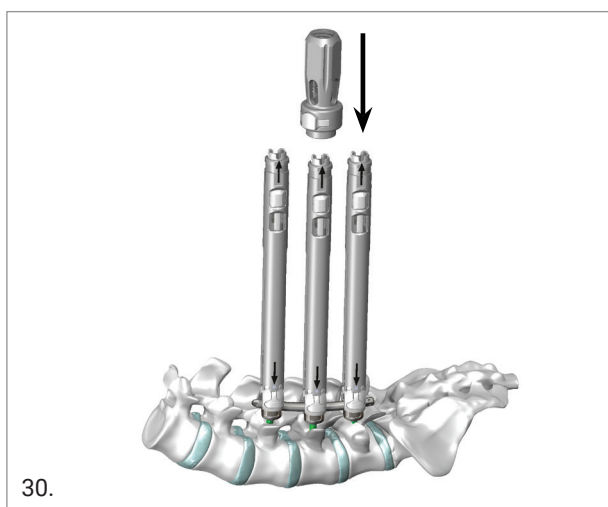

Load the set screw into the MIS Reduction Driver and slide them through the Percutaneous Tower. Screw the proximal handle of the MIS Reduction Driver until reaching the mechanical stop.

The MIS Reduction Gear can be used to facilitate this step.

In this position the set screw is in contact with the tulip and the system is ready to be secured through the setscrew.

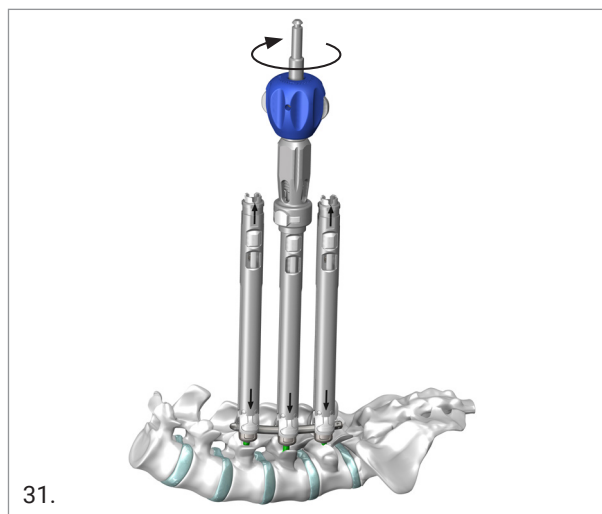

Assemble a standard handle to the inner shaft of the MIS Reduction Driver and turn it clockwise in order to load the set screw into the tulip, then proceed with final tightening.

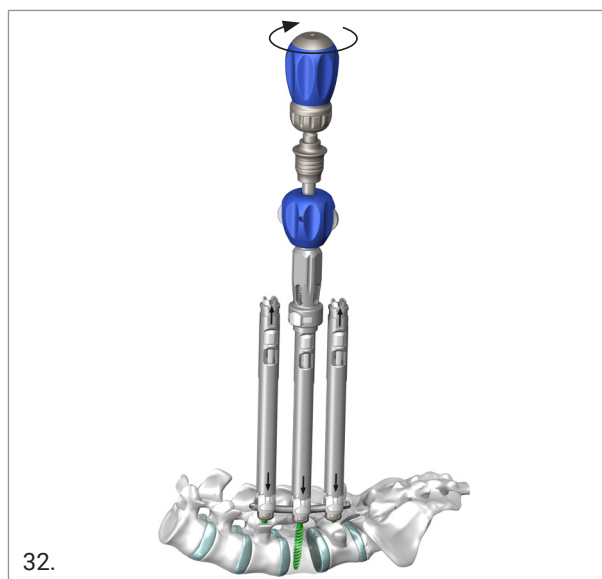

Once the set screw is in place, snap out the MIS Reduction Handle by pushing the release button.

**4.2 COMPRESSION OR DISTRACTION**

Assemble the Fulcrum Adaptor MIS and the Distractor Valve Straight to the MUST Modular Compressor/Distractor by pulling backwards the triggers and coupling the two parts with the slots on the MUST Modular Compressor/Distractor.

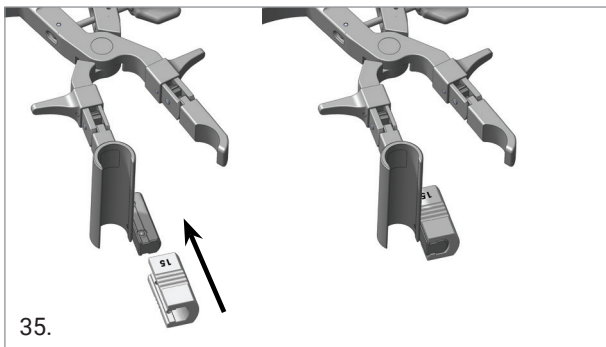
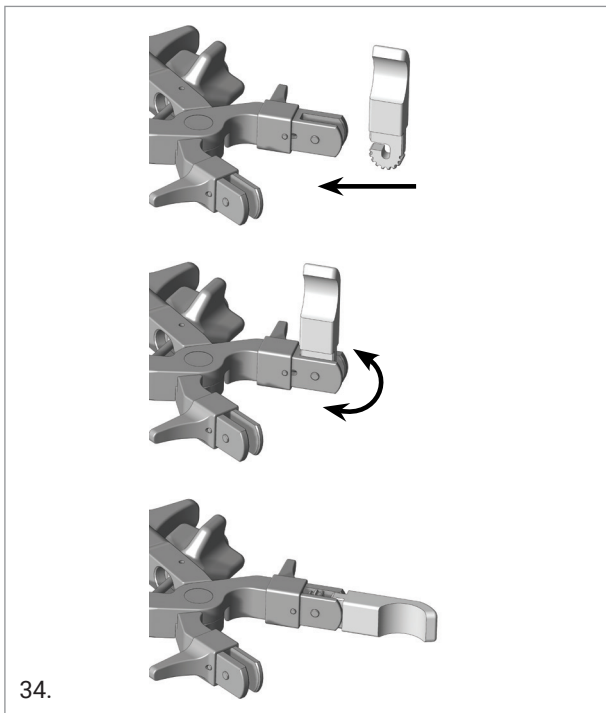
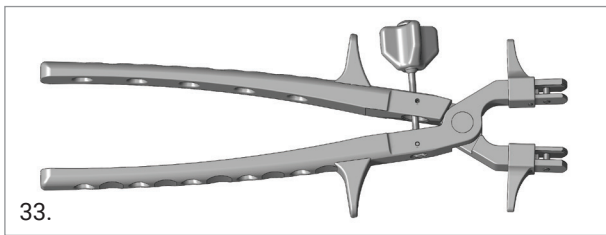

**OPTION**

It is also possible to add modular fulcrums by sliding them over the Fulcrum Adaptor MIS and/or to switch the Straight Valve with an offset one in order to reduce the distance between two Percutaneous Towers.

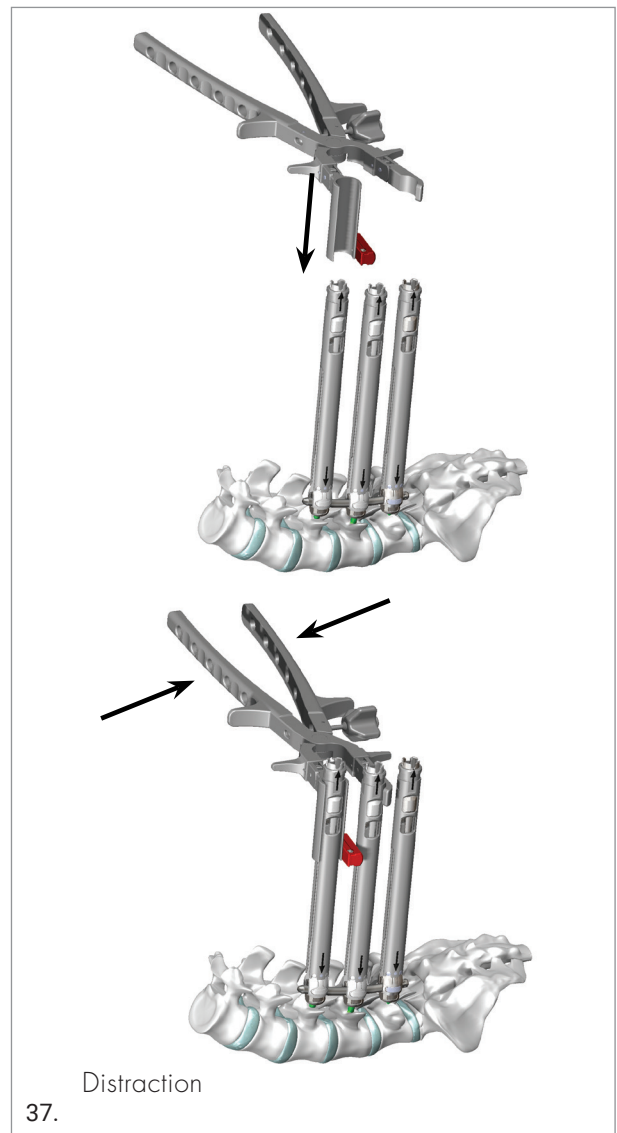
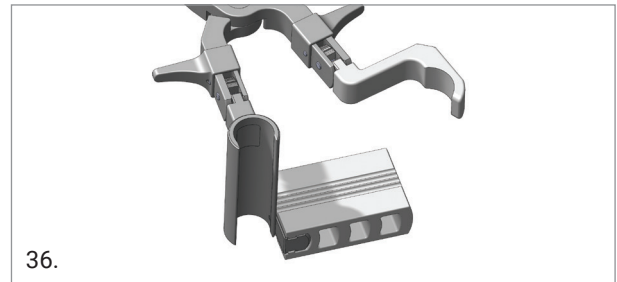

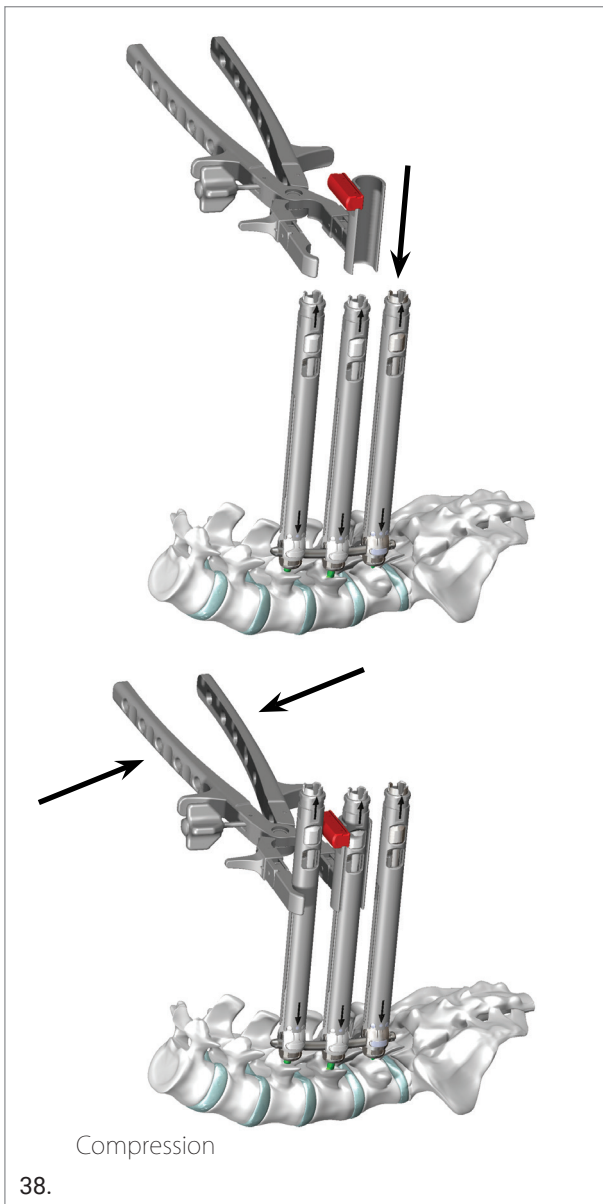

If necessary, it is also possible to tilt the Modular Compressor/Distractor pulling the triggers backwards and turning the handles up or down according to the surgeon's preferences.

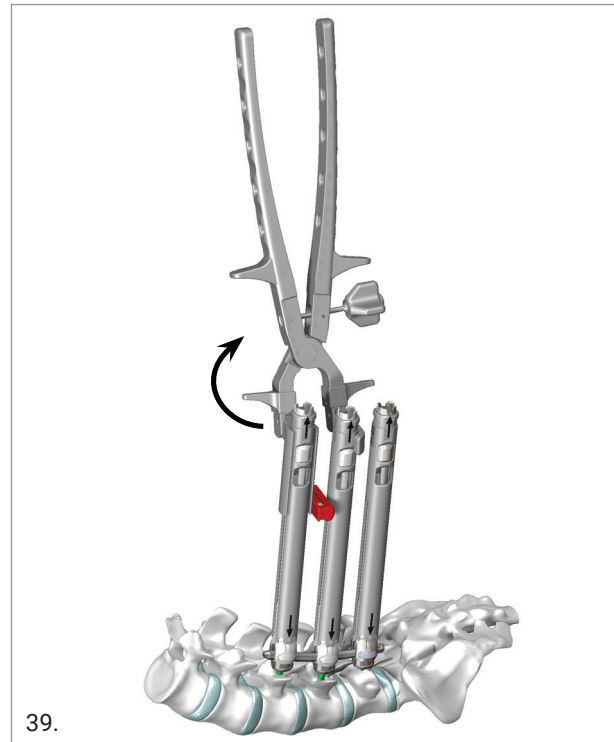

Using fluoroscopy, monitor and ensure the appropriate distraction/compression has been achieved as well as the correct seating of the rod. Once in the desired position proceed with the tightening of the set screw.

**NOTE:** The set screw at the most cranial/caudal location must be tightened while the set screw at the adjacent location needs to be loosened.

Slide the Fulcrum Adaptor MIS over the Percutaneous Tower and Apply gentle pressure to the Modular Compressor/Distractor to achieve the desired compression or distraction.

**NOTE:** When the final tightening is achieved and the Tower has been removed, if additional compression/distraction is needed, a MIS compression/distraction Extension is available to avoid reassembling the Tower.

**4.3 FINAL TIGHTENING**

The MIS Counter Torque must be coupled to the top of the Percutaneous Tower to accomplish the final tightening process.

Connect the Ratcheting Handle to the Torque Limiter Set Screwdriver and insert it into the Percutaneous Tower.

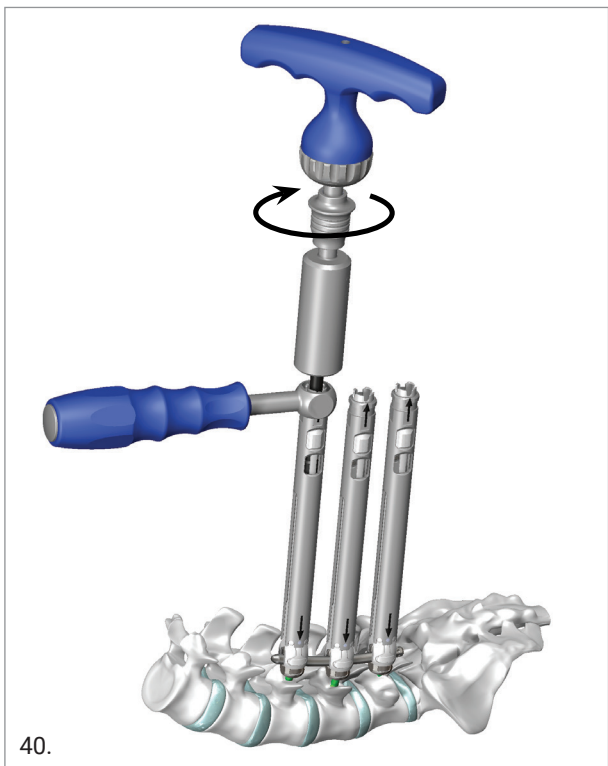

Firmly hold the MIS Counter Torque and rotate the Torque Limiter Set Screwdriver until an audible click is heard indicating that final tightening has been achieved

**4.4 TOWER REMOVAL**

When all the set screws have been tightened, the Percutaneous Towers can be released with the release instrument previously assembled.

For a correct release instrument assembly mount the Shaft with the Handle and Cap as shown and then manually tighten the cap.

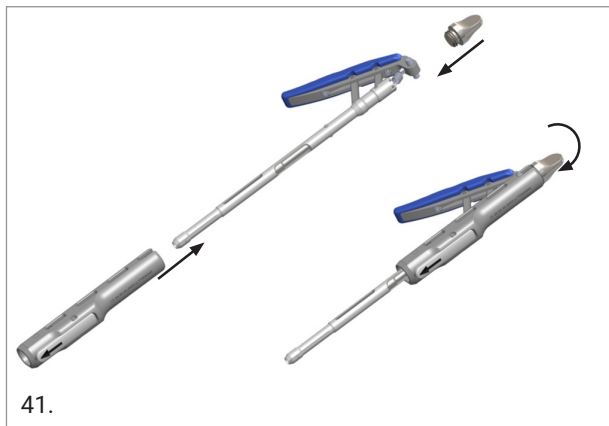

With the Tower still in “closed” position, insert the shaft of the Release System.

**CAUTION**

The button must be aligned with the window of the Tower. See marked arrows for indication.

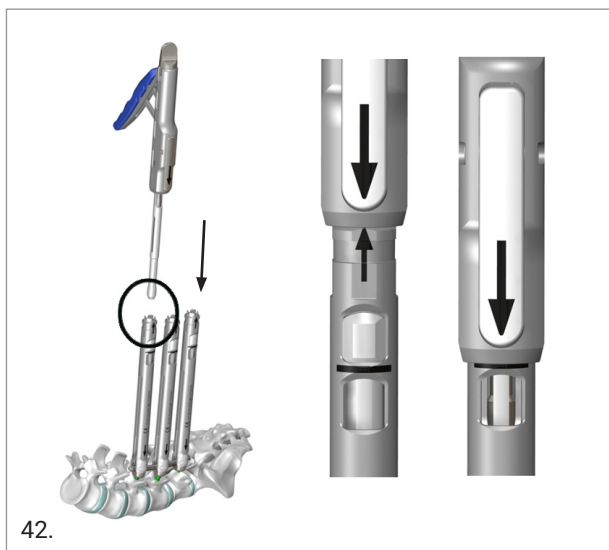

Squeeze completely the blue lever of the Release System, then gently pull the Tower outside the surgical field.



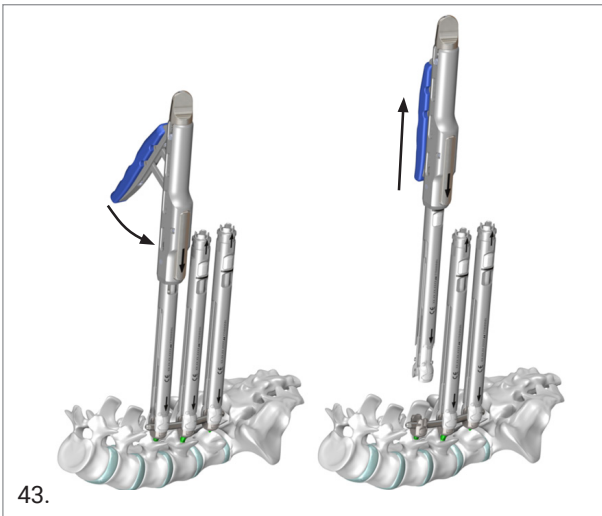

**NOTE:** Ensure that the blue lever is fully closed before pulling the Tower: The Tower needs to have reached the "OPEN" position (the button of the Inner Sleeve will reach the lower window of the Outer Sleeve of the Tower).

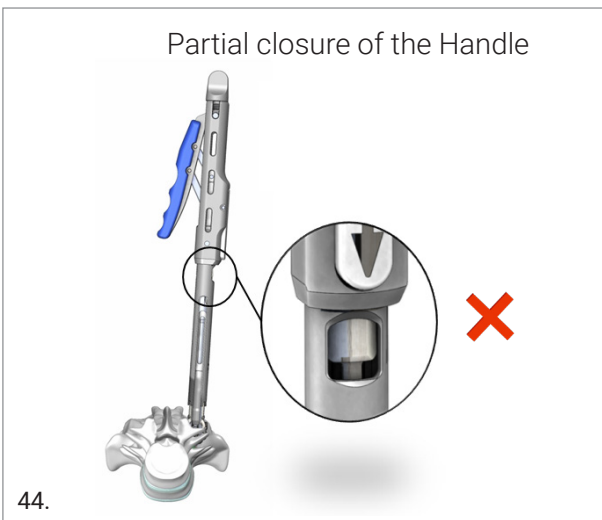

To un-couple the Tower from the Release System, open the blue lever then pull away the Tower.

**NOTE:** In case the Perc. Tower remains caught within the Release System, pull the tower from the extremity of the inner sleeve with the handle in closed position, then open. If necessary, disassemble the Release System by removing the Cap.

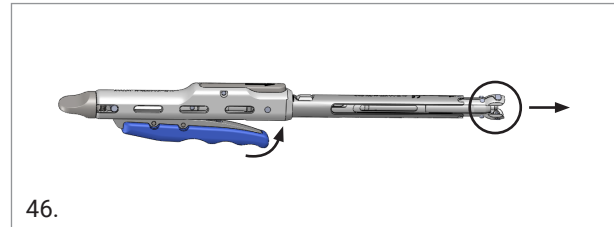

## 5. RESCUE INSTRUMENT

In case the Tower is unintentionally removed from the screw before rod & set screw insertion, the MIS Rescue instrument can be used to help re-engage it.

Target the screw with a K-Wire (optional) and then with the Rescue instrument. The tip of the rescue instrument engages and drives the pedicle screw head.

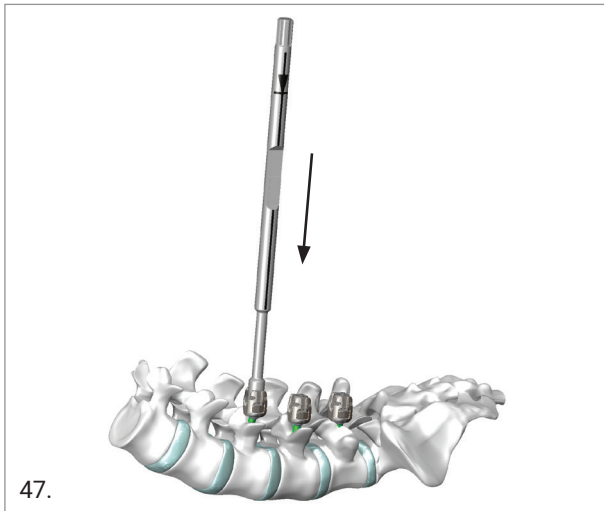

Set the tower in open position and slide it over the rescue instrument, aligned according to the markings. When the marked arrows face each other, the tower can be switched to the closed position and then the rescue instrument can be removed.

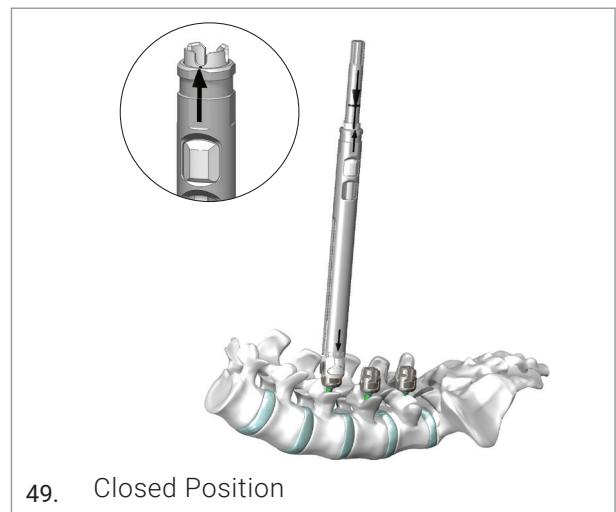

## 6. IMPLANTS NOMENCLATURE

### ENHANCED POLY-AXIAL PEDICLE SCREW - CANNULATED

Reference <sup>1</sup>	Size - ØxL [mm]
03.52.311	5x25
03.52.312	5x30
03.52.313	5x35
03.52.314	5x40
03.52.315	5x45
03.52.316	5x50
03.52.320	6x25
03.52.321	6x30
03.52.322	6x35
03.52.323	6x40
03.52.324	6x45
03.52.325	6x50
03.52.326	6x55
03.52.327	6x60
03.52.328	6x65
03.52.335	7x30
03.52.336	7x35
03.52.337	7x40
03.52.338	7x45
03.52.339	7x50
03.52.340	7x55
03.52.341	7x60
03.52.342	7x65
03.52.343	7x70
03.52.345	7x80
03.52.347	7x90
03.61.353*	8x30
03.61.354*	8x35
03.61.355*	8x40
03.61.356*	8x45
03.61.357*	8x50
03.61.358*	8x55
03.61.361*	8x70
03.61.363*	8x80
03.61.365*	8x90
03.61.371*	9x40
03.61.372*	9x45
03.61.373*	9x50
03.61.374*	9x55
03.61.377*	9x70
03.61.379*	9x80
03.61.381*	9x90
03.61.393*	10x70
03.61.395*	10x80
03.61.397*	10x90

<sup>1</sup> Includes 1 screw and 1 set screw

\*Note: These screws are fenestrated and with dual diameter also. For screw augmentation procedures, see surgical technique 99.46FS.12.

### MONOAXIAL CANNULATED PEDICLE SCREW\*

Reference <sup>1</sup>	Size - ØxL [mm]
03.52.206	5x30
03.52.207	5x35
03.52.201	5x40
03.52.202	5x45
03.52.203	5x50
03.52.204	5x55
03.52.205	5x60
03.52.216	6x30
03.52.217	6x35
03.52.211	6x40
03.52.212	6x45
03.52.213	6x50
03.52.214	6x55
03.52.215	6x60
03.52.227	7x35
03.52.221	7x40
03.52.222	7x45
03.52.223	7x50
03.52.224	7x55
03.52.225	7x60

<sup>1</sup> Includes 1 screw and 1 set screw

\*Note: Monoaxial Cannulated Pedicle Screws are also fenestrated with the exception of the reference number 03.52.206 (Monoaxial Cannulated Pedicle Screw 5X30mm) and 03.52.216 (Monoaxial Cannulated Pedicle Screw 6X30mm). For screw augmentation procedures, see surgical technique ref. 99.FS46.12.

**ENHANCED BENT ROD, RADIO 200MM**

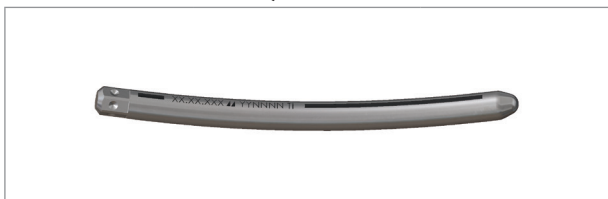

Ti Rod	Size - ØxL [mm]	CoCr Rod
03.52.421	5.5x25	03.52.521
03.52.422	5.5x30	03.52.522
03.52.423	5.5x35	03.52.523
03.52.424	5.5x40	03.52.524
03.52.425	5.5x45	03.52.525
03.52.426	5.5x50	03.52.526
03.52.427	5.5x55	03.52.527
03.52.428	5.5x60	03.52.528
03.52.429	5.5x65	03.52.529
03.52.430	5.5x70	03.52.530
03.52.431	5.5x75	03.52.531
03.52.432	5.5x80	03.52.532
03.52.433	5.5x85	03.52.533
03.52.434	5.5x90	03.52.534
03.52.435	5.5x95	03.52.535
03.52.436	5.5x100	03.52.536
03.52.438	5.5x110	03.52.538
03.52.440	5.5x120	03.52.540
03.52.442	5.5x130	03.52.542
03.52.444	5.5x140	03.52.544
03.52.446	5.5x150	03.52.546

**ENHANCED BENT ROD, RADIO 100MM**



Ti Rod	Size - ØxL [mm]	CoCr Rod
03.52.451	5.5x25	03.52.551
03.52.452	5.5x30	03.52.552
03.52.453	5.5x35	03.52.553
03.52.454	5.5x40	03.52.554
03.52.455	5.5x45	03.52.555
03.52.456	5.5x50	03.52.556
03.52.457	5.5x55	03.52.557
03.52.458	5.5x60	03.52.558
03.52.459	5.5x65	03.52.559
03.52.460	5.5x70	03.52.560
03.52.461	5.5x75	03.52.561
03.52.462	5.5x80	03.52.562
03.52.463	5.5x85	03.52.563
03.52.464	5.5x90	03.52.564
03.52.465	5.5x95	03.52.565
03.52.466	5.5x100	03.52.566
03.52.468	5.5x110	03.52.568
03.52.470	5.5x120	03.52.570
03.52.472	5.5x130	03.52.572
03.52.474	5.5x140	03.52.574
03.52.476	5.5x150	03.52.576

**ENHANCED DUAL BENT ROD**



Ti Rod	Size - ØxL [mm]	CoCr Rod
03.52.486	5.5x50mm	03.52.586
03.52.488	5.5x60mm	03.52.588
03.52.490	5.5x70mm	03.52.590
03.52.492	5.5x80mm	03.52.592

**ANODIZED RODS**



Ref. (Sterile)	Description
03.52.814	Enhanced Rod Ti Anodized5.5x100mm
03.52.815	Enhanced Rod Ti Anodized5.5x200mm
03.52.816	Enhanced Rod Ti Anodized5.5x300mm
03.52.817	Enhanced Rod Ti Anodized5.5x480mm

### ENHANCED STRAIGHT ROD



Ti Rod	Size - ØxL [mm]	CoCr Rod
03.52.401	5.5x35	03.52.501
03.52.402	5.5x40	03.52.502
03.52.403	5.5x45	03.52.503
03.52.404	5.5x50	03.52.504
03.52.405	5.5x55	03.52.505
03.52.406	5.5x60	03.52.506
03.52.407	5.5x65	03.52.507
03.52.408	5.5x70	03.52.508
03.52.409	5.5x75	03.52.509
03.52.410	5.5x80	03.52.510
03.52.411	5.5x85	03.52.511
03.52.412	5.5x90	03.52.512
03.52.414	5.5x100	03.52.514
03.52.415	5.5x200	03.52.515
03.52.416	5.5x300	03.52.516
03.52.417	5.5x480	03.52.517

**NOTES**

---

---

---

---

---

---

---

---

---

---

---

---

---

---

---

---

---

---

---

---

---

---

---

---

---

Part numbers subject to change.

## **NOTE FOR STERILISATION**

The instrumentation is not sterile upon delivery. It must be cleaned before use and sterilised in an autoclave respecting the regulations of the country, EU directives where applicable and following the instructions for use of the autoclave manufacturer. For detailed instructions please refer to the document "Recommendations for cleaning decontamination and sterilisation of Medacta International orthopedic devices" available at [www.medacta.com](http://www.medacta.com).



---

**REDEFINING BETTER  
IN ORTHOPAEDICS  
AND SPINE SURGERY**

---

MEDACTA.COM



**Medacta International SA**  
Strada Regina - 6874 Castel San Pietro - Switzerland  
Phone +41 91 696 60 60 - Fax +41 91 696 60 66  
info@medacta.ch

Find your local dealer at: [medacta.com/locations](https://www.medacta.com/locations)

All trademarks and registered trademarks are the property of their respective owners.  
Please verify approval of the devices described in this document with your local Medacta representative.

M.U.S.T. Percutaneous  
Surgical Technique

ref: 99.PERC46.12  
rev. 04

Last update: August 2019